

How to Load and Generate RDOS

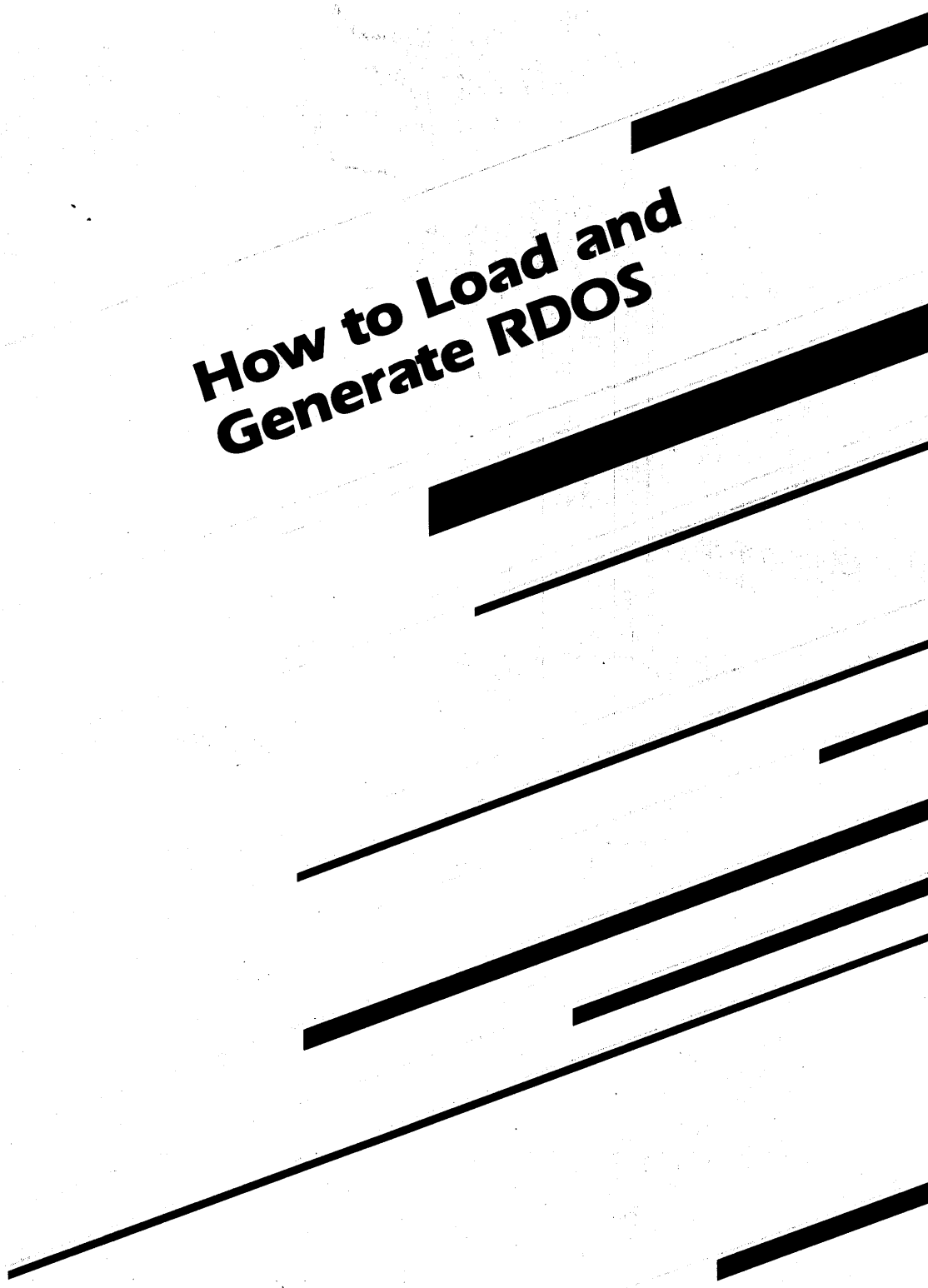



How to Load and Generate RDOS

Notice

DATA GENERAL CORPORATION (DGC) HAS PREPARED THIS DOCUMENT FOR USE BY DGC PERSONNEL, CUSTOMERS, AND PROSPECTIVE CUSTOMERS. THE INFORMATION CONTAINED HEREIN SHALL NOT BE REPRODUCED IN WHOLE OR IN PART WITHOUT DGC PRIOR WRITTEN APPROVAL.

DGC reserves the right to make changes in specifications and other information contained in this document without prior notice, and the reader should in all cases consult DGC to determine whether any such changes have been made.

THE TERMS AND CONDITIONS GOVERNING THE SALE OF DGC HARDWARE PRODUCTS AND THE LICENSING OF DGC SOFTWARE CONSIST SOLELY OF THOSE SET FORTH IN THE WRITTEN CONTRACTS BETWEEN DGC AND ITS CUSTOMERS. NO REPRESENTATION OR OTHER AFFIRMATION OF FACT CONTAINED IN THIS DOCUMENT INCLUDING BUT NOT LIMITED TO STATEMENTS REGARDING CAPACITY, RESPONSE-TIME PERFORMANCE, SUITABILITY FOR USE OR PERFORMANCE OF PRODUCTS DESCRIBED HEREIN SHALL BE DEEMED TO BE A WARRANTY BY DGC FOR ANY PURPOSE, OR GIVE RISE TO ANY LIABILITY OF DGC WHATSOEVER.

IN NO EVENT SHALL DGC BE LIABLE FOR ANY INCIDENTAL, INDIRECT, SPECIAL OR CONSEQUENTIAL DAMAGES WHATSOEVER (INCLUDING BUT NOT LIMITED TO LOST PROFITS) ARISING OUT OF OR RELATED TO THIS DOCUMENT OR THE INFORMATION CONTAINED IN IT, EVEN IF DGC HAS BEEN ADVISED, KNEW OR SHOULD HAVE KNOWN OF THE POSSIBILITY OF SUCH DAMAGES.

CEO, DASHER, DATAPREP, ECLIPSE, ENTERPRISE, INFOS, microNOVA, NOVA, PROXI, SUPERNOVA, PRESENT, ECLIPSE MV/4000, ECLIPSE MV/6000, ECLIPSE MV/8000, TRENDVIEW, SWAT, GENAP, and MANAP are U.S. registered trademarks of Data General Corporation, and **AZ-TEXT, DG/L, ECLIPSE MV/10000, GW/4000, GDC/1000, REV-UP, XODIAC, DEFINE, SLATE, microECLIPSE, BusiPEN, BusiGEN** and **BusiTEXT** are U.S. trademarks of Data General Corporation.

Revision History:

093-000188

Original Release - December 1975

First Revision - August 1978

Second Revision - July 1979

069-400013

Original Release - September 1983

This manual, supersedes *How to Generate Your RDOS System* (093-000188-02)

Ordering No. 069-400013

©Data General Corporation, 1983

All Rights Reserved

Printed in the United States of America

Rev. 00, October 1983

Preface

This book steps readers through the procedures of loading, generating, and maintaining the Real-time Disk Operating System (RDOS). It is intended as a tutorial for first-time users and as a reference for those already familiar with RDOS.

Organization

Chapter 1, Overview, defines the concepts of system loading and generation; describes the RDOS software package; discusses the use of RDOS-supported computers and devices; and explains how to use this book.

Chapter 2, "System Loading," explains how to prepare a hard disk and load it with system software.

Chapter 3, "System Generation," introduces the system generator (SYSGEN), explains the questions that it asks, and assists users in tailoring an RDOS system.

Chapter 4, "System Maintenance," explains the procedures of starting up and closing down RDOS, introducing new disks, backing up files, tuning, and patching.

Chapter 5, "The Disk Initializer," describes the full functionality of DKINIT, a program that prepares disks and diskettes to hold software.

Appendix A lists the RDOS utilities and source files, along with applicable documentation.

Appendix B describes exceptional conditions that can occur during system loading and generation and explains how to recover from them.

Appendix C contains the ASCII character set.

Related Manuals

First-time users of RDOS should read the *Introduction to RDOS* (DGC No. 069-400011) and *RDOS/DOS Command Line Interpreter* (DGC No. 069-400015) before using this manual.

Once you have loaded and generated an RDOS system, the following manuals will assist you in using it.

- *Introduction to RDOS* (DGC No. 069-400011) describes the fundamentals of using RDOS and summarizes the features, utilities, and capabilities of the operating system.
- *Guide to RDOS Documentation* (DGC No. 069-400012) describes all of the books that comprise the revised documentation set for RDOS and lists the previous books that each replaces.
- *RDOS/DOS Command Line Interpreter* (DGC No. 069-400015) discusses the user interface with the operating system. It covers the Command Line Interpreter (CLI) features and command mechanisms, as well as instructions on how to use CLI commands. It also presents features and operation of the Batch monitor, a CLI utility.
- *RDOS/DOS Text Editor* (DGC No. 069-400016) documents how to load, use, and operate the single-user Text Editor (Edit) or Multi-User Text Editor (Medit) to create and edit text files.
- *RDOS/DOS Superedit Text Editor* (DGC No. 069-400017) introduces the commands and concepts of the Superedit Text Editor (Speed), which offers many powerful features for editing text.
- *RDOS System Reference* (DGC No. 093-400027) describes RDOS system features, system calls, and user device driver implementation for assembly language and high-level language programming.
- *RDOS/DOS Assembly Language and Program Utilities* (DGC No. 069-400019) details the Extended Assembler (ASM), Macroassembler (MAC), Extended Relocatable Loader (RLDR and OVLDR), and Library File Editor (LFE) utilities that aid in programming.
- *RDOS/DOS Debugging Utilities* (DGC No. 069-400020) describes five utilities that assist you in editing, debugging, and patching programs—the Symbolic Editor (SEdit), Symbolic Debugger (DEBUG), Disk Editor (DSKED), and Patch (ENPAT and PATCH).

- *RDOS/DOS Sort/Merge and Vertical Format Unit Utilities* (DGC No. 069-400021) offers functional information on Sort/Merge (RDOSSORT), which helps you manipulate records in data files, and the Vertical Format Unit (VFU), which enables you to define data channel line printer page formatting.
- *RDOS/DOS Backup Utilities* (DGC No. 069-400022) presents the features and operation of the utilities that perform disk and tape backup. These are BURST/TBURST, DBURST/MBURST/RBURST, DDUMP/DLOAD, FDUMP/FLOAD, and OWNER.

Typesetting Conventions

We use the following conventions for command formats in this manual:

COMMAND *required* [optional]

Where	Means
COMMAND	Enter the command or its accepted abbreviation as shown. Uppercase letters indicate the command mnemonic.
<i>required</i>	Enter an argument such as a filename. Lowercase italic letters indicate this argument. Required arguments also appear as: <i>required</i> ₁ <i>required</i> ₂ In this case, you may choose between the arguments. Do not type the vertical bar; it merely separates the choices.
[optional]	Brackets mean that you have the option of entering the argument indicated in lowercase italic letters. Command switches also appear in this format. Do not include the brackets in your code; they only set off the choices.
...	Repeat the preceding entry or entries. The explanation indicates exactly what to repeat.
.	Where this symbol appears, the process has continued without incident and you may now take the next action described.

In examples of dialogue, we use:

THIS TYPEFACE TO SHOW YOUR ENTRY

and

THIS TYPEFACE TO SHOW SYSTEM RESPONSES.

Additionally, we use certain symbols in special ways:

Symbol	Means
<CR>	Carriage Return. Press the CR key on your keyboard. NOTE: If you have a D100, D200, or G300 terminal, you should press the New Line key (NEW LINE) on your keyboard instead.
CTRL-	Depress and hold the Control key (CTRL) while you press the character that follows CTRL-.
<NL>	New Line. Press the NEW LINE key on your keyboard.
R	RDOS/DOS Command Line Interpreter prompt.

All numbers are decimal unless we indicate otherwise; for example, to indicate octal 35, we use 35₈.

The keys defined as DEL and RUBOUT perform the same function. Depending on the console you are using, you will find one of these keys on your keyboard. In this manual, we use DEL to represent that function.

The up arrow symbol (↑) is also executed by different keys, depending on your console. You execute it by pressing either SHIFT-N or SHIFT-6. In this manual, we reference SHIFT-6 to execute the up arrow symbol.

We welcome your suggestions for the improvement of this and other Data General publications. To communicate with us, use the postpaid comment form at the end of this manual.

Table of Contents

Preface

Organization i
Related Manuals i

Chapter 1

Overview

The Real-Time Disk Operating System 1
System Loading and Generation Concepts 1
The System Loading and Generation Procedure 3
Identifying Your Hardware 8
 NOVA and ECLIPSE Computers 9
 NOVA, ECLIPSE, and Microproducts Devices 11
Getting Started 19
 Readying Your Hardware 19
Using the Console Aids 22
Charting Your Course 24

Chapter 2

System Loading

Initiating a Loader Program 25
 With the Virtual Console Option 25
 With the APL Option 26
 With Hardware Data Switches and APL 26
 With Hardware Data Switches Only 26
 Troubleshooting Guidelines 27
Initializing Your Master Disk 27
Installing the Bootstrap Root 30
 Invoking the Installer Program 30
 Executing the Installer Program 30

Installing the Starter System 31
 Installing From Magnetic Tape 31
 Installing From Diskette 32
Loading the Utilities 32
 Loading From Magnetic Tape 32
 Loading From Diskette 33
Summary 35

Chapter 3

System Generation

Tailoring Guidelines 39
 System Optimization 39
 I/O Devices 43
 SYSGEN Files 43
Running the System Generation Program 43
 Processor Type 44
 Mapped System Requirements 44
 Unmapped System Requirements 45
 Disk Drives 45
 Software Parameters 47
 Magnetic and Cassette Tape Drives 49
 Other Peripherals 49
 QTY, ULM, and ALM Multiplexors 50
 Secondary Console 52
 Core Dumps 52
 User-Defined Devices 53
 Closing Procedures 53
Testing a New System 53
Summary 54

Chapter 4

Maintaining Your System

Starting Up the System 59
 Bootstrapping From the CLI 60
Closing Down the System 61
 Handling a System Failure 61

Accessing Other Disks	62
Using the Link Entry	63
Backing Up Files	64
Diskette Back-ups	64
Magnetic Tape Back-ups	66
Tuning Your System	67
Patching Your System	68

Chapter 5

The Disk Initializer

Overview	71
DKINIT Functions	72
FULL Command	73
PARTIAL Command	75
TEST Command	75
LIST Command	76
DISK Command	76
FRAME Command	76
REMAP Command	77
ENTER Command	78
STOP Command	79

Appendix A 81

RDOS Utilities

Appendix B

Exceptional Conditions

Bootstrapping Checklist	85
RDOS Error Messages	85

Appendix C 87

ASCII Character Set

Index 89

DG Offices

How to Order Technical Publications

ISD User Documentation Remarks Form

Users' Group Membership Form

Tables

1.1 Versions of the Real-time Disk Operating System	3
1.2 System software on magnetic tape	4
1.3 System software on diskette	5
1.4 NOVA/ECLIPSE disk and diskette drive combinations	15
1.5 Microproducts disk and diskette drive combinations	16
1.6 Device identifiers, NOVA/ECLIPSE disk and diskette drives	18

1.7 Device identifiers, Microproducts disk and diskette drives	19
1.8 Console aids recognized by system software	23
1.9 Console aids recognized by the virtual console	23
2.1 Virtual console entries before system generation	25
2.2 Settings for data switches before system generation	26
2.3 Disk drive models and unit names	28
2.4 Diskette drive names before system generation	33
2.5 Variables in system loading procedures	35
3.1 System features and corresponding memory requirements	40
3.2 Microproducts fixed disks and diskettes	47
3.3 Recommended stack allocations	48
4.1 Program loading after system generation	60
4.2 Diskette identifiers for back-up	64
5.1 DKINIT commands and their functions	72
5.2 Error messages from the main program	73
5.3 DKINIT test patterns	73
5.4 Error messages from FULL command	74
5.5 Error messages from PARTIAL command	75
5.6 Frame sizes for RDOS-supported disks	77
5.7 Error messages from REMAP command	78
5.8 Error messages from ENTER command	79

Figures

1.1 RDOS loading and generation	6
1.2 A sample RDOS installation	8
1.3 Front panel features	10
1.4 Fixed-disk drives	11
1.5 Cartridge disk drive	12
1.6 Disk pack and drive	13
1.7 Double-density diskette drive	13
1.8 Single-density diskette drive	14
1.9 Inserting a diskette	20
1.10 Loading a cartridge disk	21
1.11 Loading a disk pack	22
2.1 Dialogue between system software and user with ECLIPSE computer, release software on quad diskette, and model 6222 disk	36
2.2 Dialogue between system software and user with NOVA 4 computer, release software on tape, and model 6060 disk	37
3.1 Sample generation of mapped S/20 system supporting Microproducts peripherals	55
3.2 Sample generation of mapped S/280 system	56
3.3 Sample generation of mapped NOVA 4 system	57
3.4 Sample generation of unmapped C/150 system	57
3.5 Sample generation of unmapped NOVA 4 system	58
4.1 Sample printout of tuning file	67

Chapter 1

Overview

This chapter prepares readers to load and generate an RDOS system by summarizing each step of the system generation process.

The first section of the chapter introduces the Real-time Disk Operating System (RDOS). The second section defines the concepts, programs, and procedures of RDOS system generation. A discussion of RDOS-supported computers and devices helps readers to identify their hardware components. In conclusion, the chapter provides instructions for readying your hardware, using the console aids, and charting your course through this book.

The Real-Time Disk Operating System

The Data General Real-time Disk Operating System supports both real-time and batch operations in a flexible, user-oriented environment. Among its many features, RDOS offers efficient management of critical system resources, including memory configurations from 32 Kbytes to 2 Mbytes in size; mapped or unmapped dual-ground processing, allowing independent programs to run simultaneously; and support for an extensive range of high-level languages and utilities. RDOS is compatible with the Data General Real-Time Operating System (RTOS) and Disk Operating System (DOS). It runs on a wide range of NOVA[™] and ECLIPSE[™] configurations, including those that support Microproducts peripherals.

RDOS performs such tasks as real-time process control, medical testing, laboratory instrumentation, simulation and modeling, image processing, data communications, energy management, security monitoring, airline ticketing, and inventory control.

System Loading and Generation Concepts

System loading and generation are the processes by which an interface is established between a computer and the application that uses its resources. This interface is the operating system—a group of programs that enable a user to access the hardware without having to understand the details of its operation. Access to processor time, memory, and I/O devices are all managed by the operating system in an

efficient and orderly way. During system generation, you build an operating system suited specifically to your hardware resources and application needs.

To load and generate your RDOS system, you will execute the following procedures: program loading, bootstrapping, initializing, installing, and tailoring. These and other terms are defined in this section to aid your understanding of system loading and generation concepts as they pertain to RDOS.

Program loading. Hardware and software are interdependent: a computer cannot perform usefully unless instructed to do so, while an instruction cannot be executed without the resources—particularly the memory—of a computer. The two come together when programs are *loaded* into the computer. Program loading refers broadly to the transfer of instructions, or programs containing them, from a peripheral device or extended memory to main memory. In this book, program loading most often refers to the initiation of a *loader program*, when hardware and software first interact.

Loader program. A loader program begins the system loading process by instructing the computer to read the first block of system software from the medium on which the first block resides. The loader program—a set of approximately 30 assembly language instructions—is initiated with the virtual console or automatic program load (APL) features of some computers, or the hardware data switches of others. (See Chapter 2, “Initiating a Loader Program.”)

System software. This software includes all the programs used to load and generate an operating system. Tables 1.2 and 1.3, shown later in this chapter, introduce these programs and their functions.

Bootstrapping. The process of bringing an operating system into the main memory of a computer can be compared to the process of “pulling oneself up by the bootstraps.” In this case, a loader program pulls in a series of instructions called the *bootstrap root*; the root brings in a longer routine, to which it belongs, behind it; and the bootstrap routine enables the computer to execute the larger disk initializer and starter system programs.

Bootstrap routine. This fragment of software, named BOOT, consists of a bootstrap root and installer. Its first two blocks, or *root*, pull the rest of the routine into memory. The root is the first portion of system software that the computer, directed by a loader program, will read. It is also the first to be written on a blank disk by the bootstrap installer; this enables you to bootstrap the system that will eventually reside there.

Initializing. This procedure readies a blank disk to hold your system software. It is performed by a program called DKINIT. DKINIT identifies the size and type of the disk; reads and writes patterns to every sector on the disk's surface, checking it for flaws; and records any flaws in a bad block table.

Installing. Files are said to be installed on a disk when a program writes data to it directly, without the assistance or supervision of the operating system.

Starter System. The starter system is a generic operating system—one that accommodates virtually all RDOS-supported hardware. Its purpose is to load and execute programs—the Command Line Interpreter (CLI) and system generator (SYSGEN) among them—that enable you to tailor an RDOS system to your needs.

Tailoring. The process of defining an environment specific to your needs and building an operating system to manage it is known as tailoring. SYSGEN, an interactive program, creates this system using specifications that you supply.

Master disk. In this book, a master disk is the one that will eventually hold your system software.

Release medium. A medium, in the general sense, is a magnetic surface on which data are, or can be, recorded. The term *release medium* refers to those surfaces containing your Data General-supplied software. You will find the terms *release diskette* and *release tape* used interchangeably with *release medium*.

The System Loading and Generation Procedure

This section defines each major step in the process of loading and generating RDOS and describes the software used for each step.

Table 1.1 lists the several versions of RDOS distributed by Data General. Except where otherwise noted, these versions are released on one reel of magnetic tape, two double-density diskettes, or five single-density diskettes. This book uses the acronym RDOS to refer to all versions unless they require special treatment.

Version	Description
MRDOS	Mapped RDOS for NOVA computers
NRDOS	Mapped RDOS for NOVA 3 and NOVA 4 computers
URDOS	Unmapped RDOS for all NOVA computers
ARDOS, ZRDOS ¹	Mapped RDOS for ECLIPSE computers
BRDOS	Unmapped RDOS for ECLIPSE computers
TRDOS ²	Mapped RDOS for ECLIPSE S/20 computers

Table 1.1 Versions of the Real-time Disk Operating System

¹Data General releases ARDOS and ZRDOS on six, rather than five, single-density diskettes.

²DGC does not release TRDOS on single-density diskettes.

The programs you use to load and generate your system are described in Table 1.2 for magnetic tape users and in Table 1.3 for diskette users. (Appendix A describes the utilities and source files you may have received on your reel of magnetic tape or on separate single- or double-density diskettes.) Consult the Release Notice appropriate for your software revision to discover whether any program files have changed.

Figure 1.1 charts the steps you will follow to load and generate your RDOS system, along with the software corresponding to each step. This figure also traces the movement of system software between your release medium, the main memory of your computer, and your master (blank) disk.

File No.	Programs	Function
0	TBOOT.SV	Brings programs from release tape into memory and begins their execution.
1	CLI.SV, CLI.OL, CLI.ER, BOOT.SV, and BOOTSYS.SV	The save, overlay, and error files of the Command Line Interpreter (CLI) enable users to communicate with RDOS through a system console. BOOT.SV installs a bootstrap root on disk or diskette and brings programs into memory. BOOTSYS.SV is the starter system's save file. These programs cannot be read by TBOOT.
2	BOOTSYS.SV	Save file for the RDOS starter system. Contents can be read by TBOOT.
3	BOOTSYS.OL	Overlay for the RDOS starter system.
4	DKINIT.SV	Identifies a blank disk or diskette and checks its surface for flaws.
5	BOOT.SV	The bootstrap installer. Contents can be read by TBOOT. Brings programs into memory and begins their execution.

Table 1.2 System software on magnetic tape

File No.	Programs	Function
6	MAC.SV, MACXR.SV; (N)SPEED.SV, NSPEED.ER; SYSGEN.SV; RLDR.SV and RLDR.OL; and other utilities, source files, and libraries.	The macroassembler and macroassembler cross-reference generator are required when supporting multiplexed lines. The Super Text Editor (NSPEED for NOVA computers, SPEED for ECLIPSE) is needed to edit ALMSPD.SR (see file 7). SYSGEN builds an RDOS system tailored to the user's specifications. It uses the relocatable loader files (RLDR.(SV.OL)) to generate this system from five libraries in file 7 (RDOSA.LB, RDOSB.LB, etc.). Appendix A describes all other contents of file 6.
7	ALMSPD.SR and ALMSPD.RB; and RDOSA.LB, RDOSB.LB, RDOSC.LB, RDOSI.LB, and RDOSO.LB ¹	ALMSPD.SR describes operating characteristics of multiplexed lines as specified to SYSGEN. ALMSPD.RB describes default characteristics of multiplexed lines in assembled binary form. The five libraries contain overlays, initialization code, and the memory-resident portion of RDOS.

Table 1.2 System software on magnetic tape (continued)

¹Library files are preceded by a single-letter prefix that identifies the version of RDOS to which the files belong. For example, MRDOSA.LB is a library file for the mapped version of RDOS that runs on NOVA computers. (Table 1.1 lists the prefixes used for each version of RDOS.)

Location	Program	Purpose
Diskette #1	FBOOT.SV	Brings programs from the release diskette into memory and begins their execution.
Diskette #1	BOOT.SV	Installs a bootstrap root on a disk or diskette and brings longer programs into memory to begin their execution.
Diskette #1	FDBOOT.SV	Initial program to move system from diskette to hard disk.
Diskette #1	DKINIT.SV	Identifies a blank disk or diskette and checks its surface for flaws.
Diskette #1	SYS.SV and SYS.OL	Brings the starter system into memory; transfers the system, CLI, and bootstrap routine from release diskette to disk; and bootstraps the starter system from disk.
Diskette #1	FBOOTSYS.SV and FBOOTSYS.OL	Save and overlay files for the RDOS starter system.
Diskette #1	CLI.SV, CLI.OL, and CLI.ER	Save, overlay, and error files for the Command Line Interpreter (CLI), which allows users to communicate with RDOS via a system console.
Quad diskette #1 Single diskette #3	SYSGEN.SV	Builds a tailored RDOS system based on specifications supplied by the user.
Quad diskette #1 Single diskette #3	RDOSA.LB, RDOSB.LB, RDOSC.LB, RDOSI.LB and RDOSO.LB	Libraries containing initialization code, overlays, and the core-resident portion of RDOS; used by SYSGEN to build a tailored system. ¹

Table 1.3 System software on diskette

Location	Program	Purpose
Quad diskette #1 Single diskette #2 (RLDR.SV) and #3 (RLDR.OL)	RLDR.SV and RLDR.OL	Relocatable loader files used by SYSGEN to generate RDOS from the library files.
Quad diskette #1 Single diskette #2	ALMSPD.SR	Describes the operating characteristics, as specified to SYSGEN, for each asynchronous or universal multiplexor line. Required only if multiplexed lines are supported.
Quad diskette #1 Single diskette #4	ALMSPD.RB ²	Describes default characteristics for each multiplexed line in assembled binary form. Required only if multiplexed lines are supported.
Quad diskette #1 Single diskette #2	MAC.SV and MACXR.SV	Macroassembler and macroassembler cross-reference generator, respectively. Required if multiplexed lines are supported.
Quad diskette #1 Single diskette #2 ([N]SPEED.ER) and #3 ([N]SPEED.SV)	(N)SPEED.SV and (N)SPEED.ER	Save and error files for the Super Text Editor, needed to edit ALMSPD.SR when multiplexed lines are specified during system generation. (NSPEED runs on NOVA computers; SPEED on ECLIPSE computers.)

Table 1.3 System software on diskette (continued)

¹Library files are preceded by a single-letter prefix that identifies the version of RDOS to which the files belong. For example, MRDOSA.LB is a library file for the mapped version of RDOS that runs on NOVA computers. (Table 1.1 lists the prefixes used for each version of RDOS.)

²Users of ARDOS and ZRDOS will find this file on diskette #5.

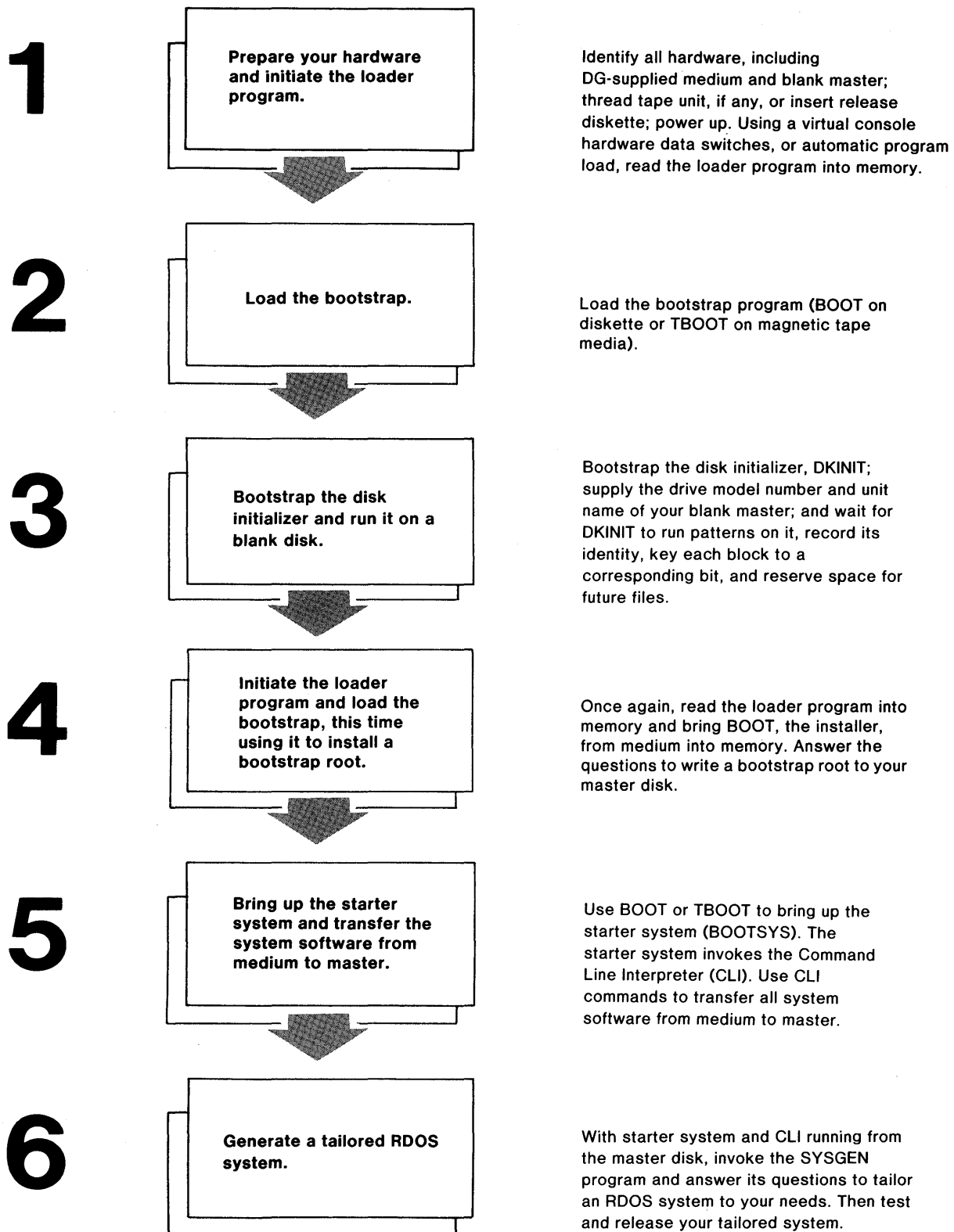
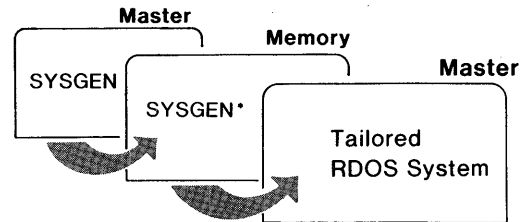
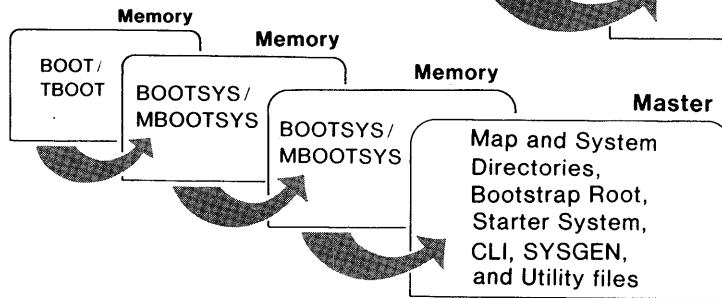
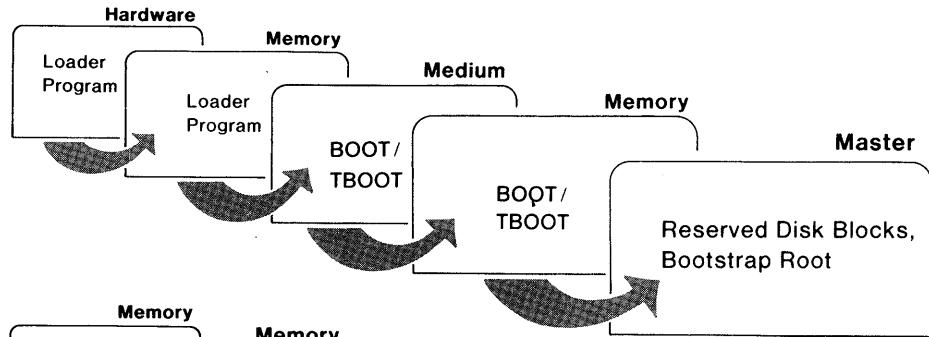
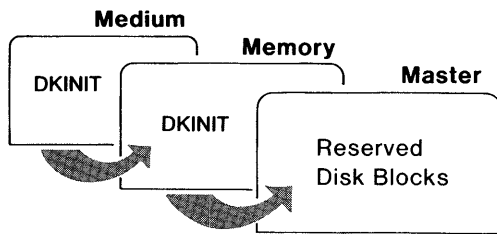
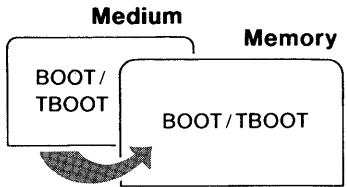
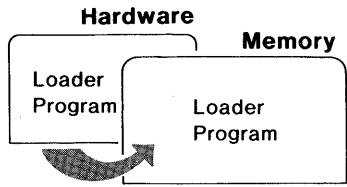

Figure 1.1 RDOS loading and generation



Identifying Your Hardware

Before you can load and generate a system, you must identify the *type of computer* and the *combination of peripherals* your installation includes. These variables determine your input to several interactive programs and your execution of certain steps.

This section acquaints you with the hardware variables an RDOS user might encounter. It introduces the program load facilities of NOVA and ECLIPSE computers; explains how to identify the device units and supplies the numbers and symbols that identify your hardware to the system generator and other programs. The discussions assume you have re-

ceived the following components and have plugged them in:

- a NOVA or ECLIPSE computer
- a diskette or magnetic tape unit
- a hard-disk subsystem or drive
- a CRT or hard-copy terminal

Figure 1.2 shows one possible configuration of these components in a sample RDOS installation.

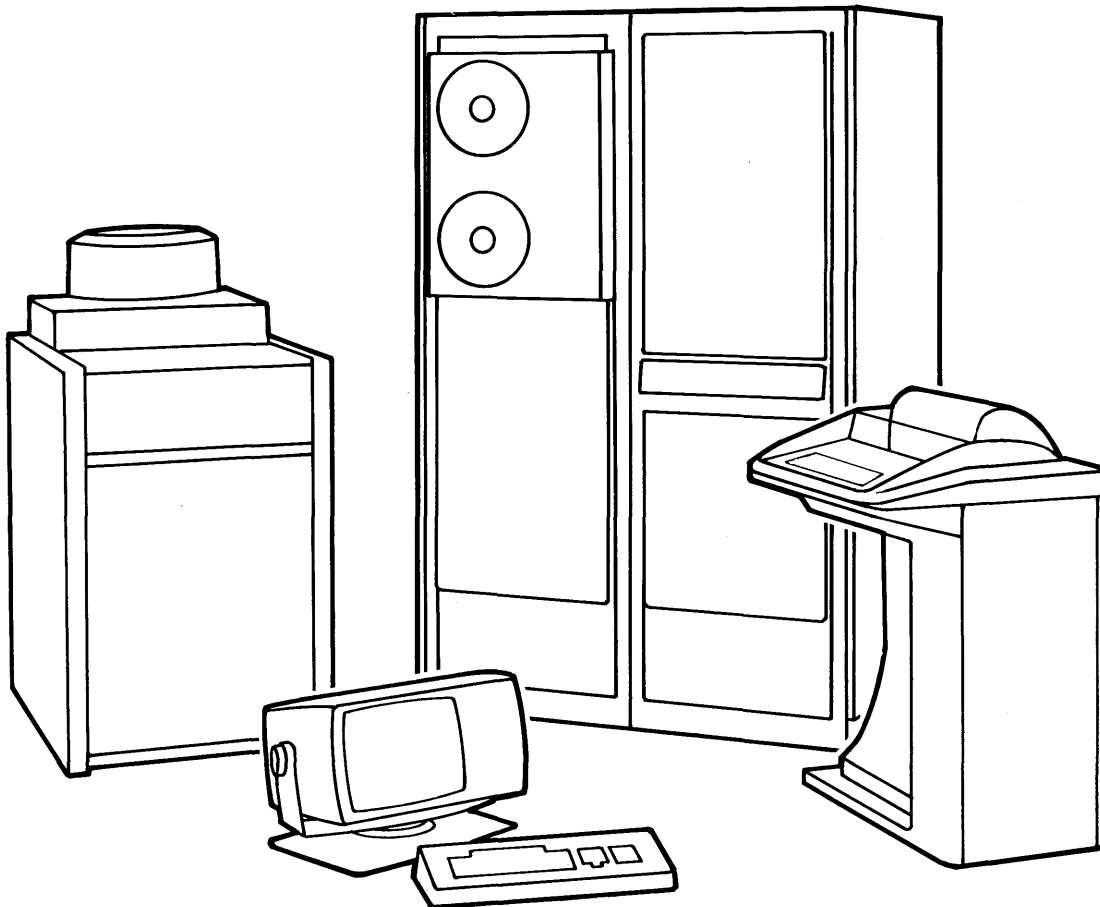

Figure 1.2 A sample RDOS installation

DG-25750

NOVA and ECLIPSE Computers

As mentioned earlier, a loader program instructs the computer to read the first block of system software—the bootstrap root—into memory. In general, the four ways of initiating a loader program correspond to four hardware options within the NOVA and ECLIPSE lines.

Machines with a virtual console allow you to initiate a loader program by typing commands to a CRT or hard-copy terminal. The virtual console prompt is an exclamation point (!) that appears on the display area of your system console after power is applied to the computer. This feature is common to NOVA 4, ECLIPSE S/20, ECLIPSE S/120, ECLIPSE S/140, and ECLIPSE S/280 machines.

Computers with an automatic program load (APL) feature also contain a loader program, initiated by pressing a rocker switch on the computer's front panel. The APL feature is included on NOVA 4, ECLIPSE S/20, ECLIPSE S/120, ECLIPSE S/140, and ECLIPSE S/280 computers.

On a third type of machine, the user supplies instructions to the central processing unit (CPU) through the hardware data switches on its front panel. These switches are numbered 0 through 15 and correspond to 16 bits, or one word, of data. You set them to 0 or 1 (up or down) to compose a 2-word loader program and transmit it to the CPU. Data switches are featured on ECLIPSE and earlier NOVA models.

Most ECLIPSE and NOVA computers feature hardware data switches in combination with automatic program load (APL). The user initiates a loader program by keying the data switches to a device code and, in most cases, pressing the RESET and PROGRAM LOAD levers.

To determine which of these features applies to your computer, compare its front panel with those shown in Figure 1.3. Chapter 2 explains how to load a program with each hardware option before system generation; Chapter 4 explains how to perform this operation after system generation.

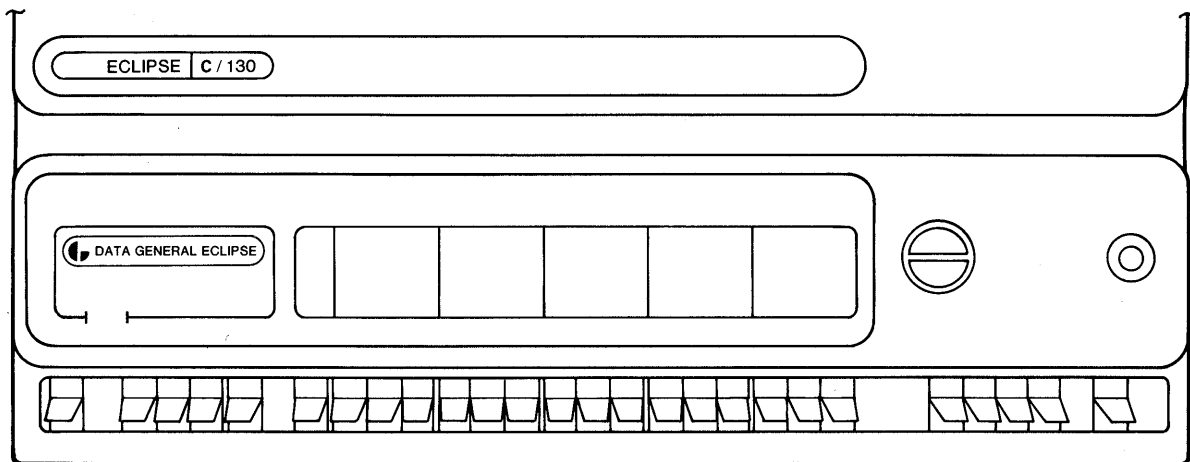
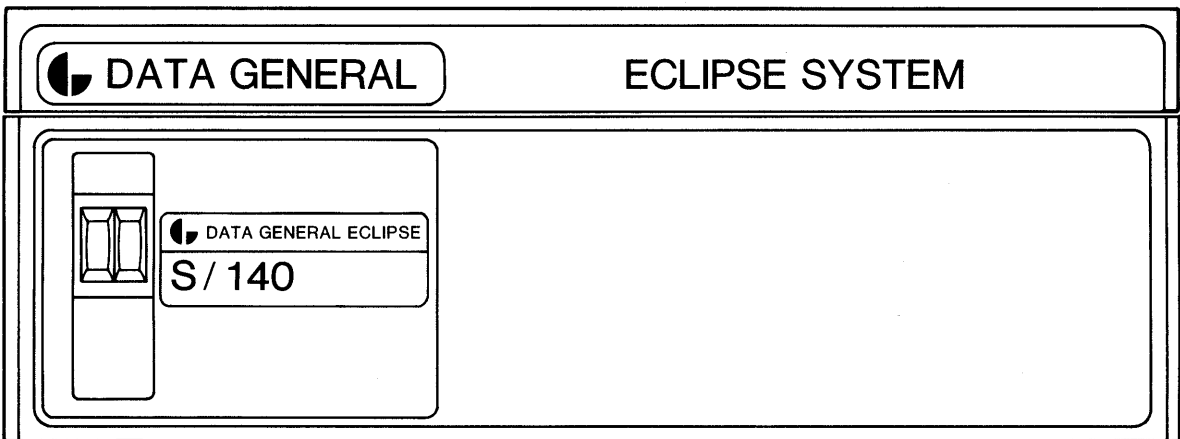
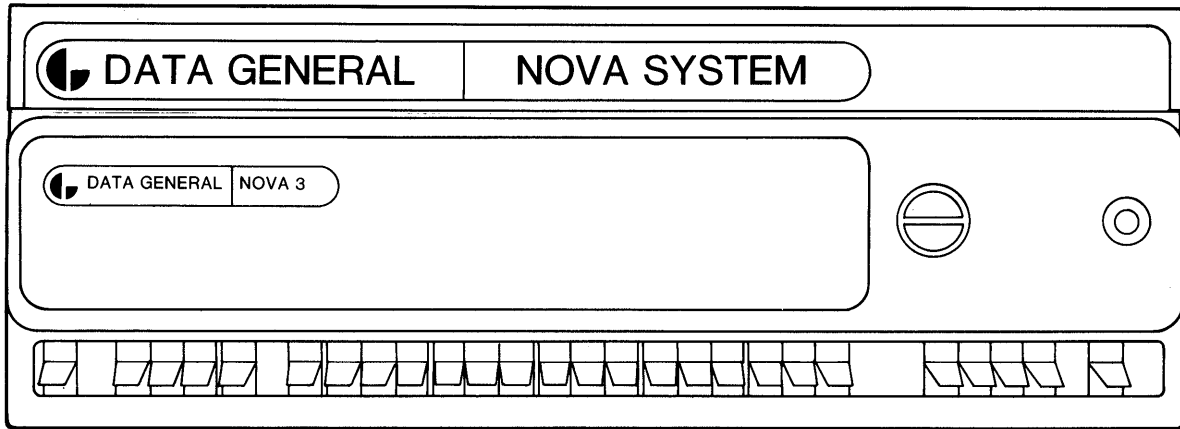

Figure 1.3 Front panel features

DG-25751

NOVA, ECLIPSE, and Microproducts Devices

A drive, or unit, is a single enclosure for a disk, a diskette, or a reel of magnetic tape. RDOS supports a range of device units from the NOVA, ECLIPSE, and Microproducts lines. For the purposes of system loading and generation, however, you will work with only two:

1. The diskette or magnetic tape unit that will hold your release medium.
2. The hard-disk unit that will hold your master disk.

Focusing on disk and diskette drives, the following discussions help you to identify these units, first singly, and then in combination with each other.

Hard-Disk and Diskette Drives

RDOS supports three types of hard-disk drives and two types of diskette drives. These drives are described below and pictured in Figures 1.4 through 1.8 for comparison with your installation.

Figure 1.4 shows three types of fixed-disk drives. The drive on the left corresponds to NOVA/ECLIPSE model 6099 and 6103 and to Microproducts model 6102 and 6105 drives. The control cluster features a power switch and two lamps. The unit-select and write-protect switches are accessible by removing the front panel. One or more double-density diskette drives can be packaged with these models.

The center drive is a fixed model of the 6200 series. It corresponds to NOVA/ECLIPSE models 6225 and 6227 and Microproducts models 6220 and 6222. Only one double-density diskette drive can be added to a unit of this series, and the unit-select and write-protect switches form part of the control cluster on the front panel.

The drive on the right corresponds to NOVA/ECLIPSE models 6063 and 6064. The unit-select and write-protect switches of these drives are accessible by sliding the drive chassis forward a few inches on its rails. These models can be configured together, but diskette drives are never added on the same controller.

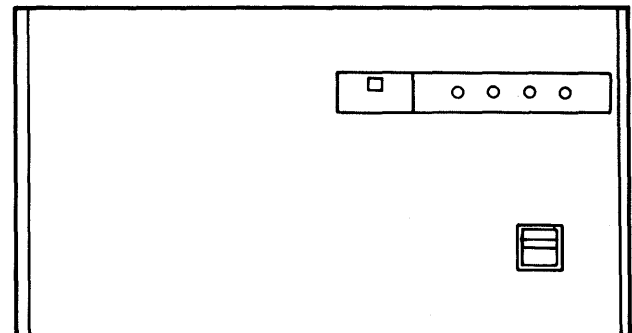
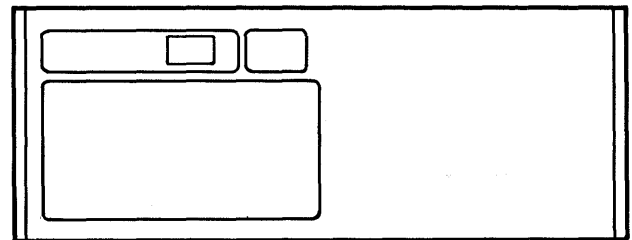
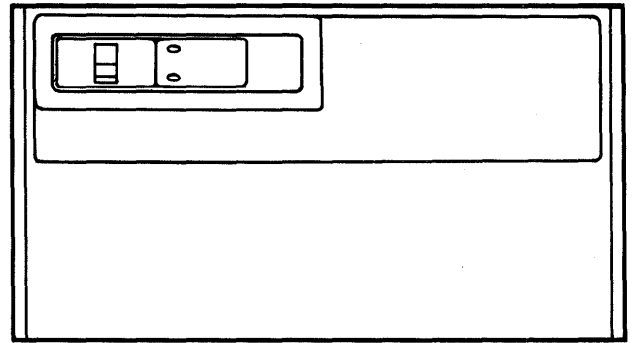

Figure 1.4 Fixed disk drives

DG-25752

Figure 1.5 shows a cartridge disk drive. The drive opens like a drawer to accept a platter-shaped cartridge containing one fixed and one removable disk. The control cluster, in the upper right-hand corner of the front panel, includes three switches (power, unit-select, and load/ready) and three lamps. The drive corresponds to NOVA/ECLIPSE models 6045 and 6070 and Microproducts model 6095.¹ Model 6045 is often configured with one or more single-density diskette drives on the same controller.

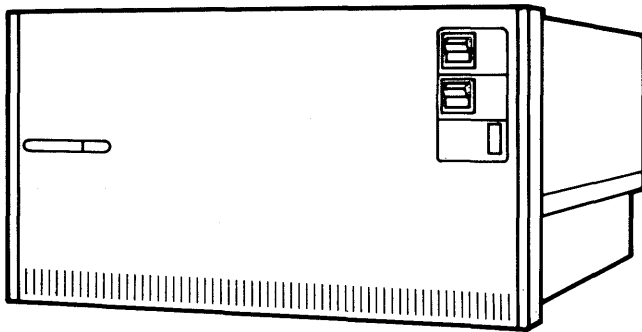

Figure 1.5 Cartridge disk drive

DG-25753

Figure 1.6 shows a freestanding drive that houses a removable pack of disks. (The number of platters per pack varies with the drive model.) Drives of this type are accompanied by an adapter whose power is controlled by a two-position circuit breaker on its front panel. The front panel of the drive itself features DRIVE, DC POWER, and WRITE switches; ON, CHECK, READY, and (write) ENABLED lamps; and a nonelectrical unit indicator. Two circuit breakers behind the cabinet control ac power to the drive and dc power to the head positioner of the drive. Figure 1.6 is representative of NOVA/ECLIPSE models 6122, 6060, 6061, and 6067.² These models can be configured together, but diskette drives are never packaged with them.

¹ Although the drives are not shown, RDOS also supports earlier cartridge models 4237, 4238, 4047, and 4234 from the NOVA/ECLIPSE line.

² Although the drives are not shown, RDOS also supports earlier disk pack models 4231, 4048, and 4057 from the NOVA/ECLIPSE line.

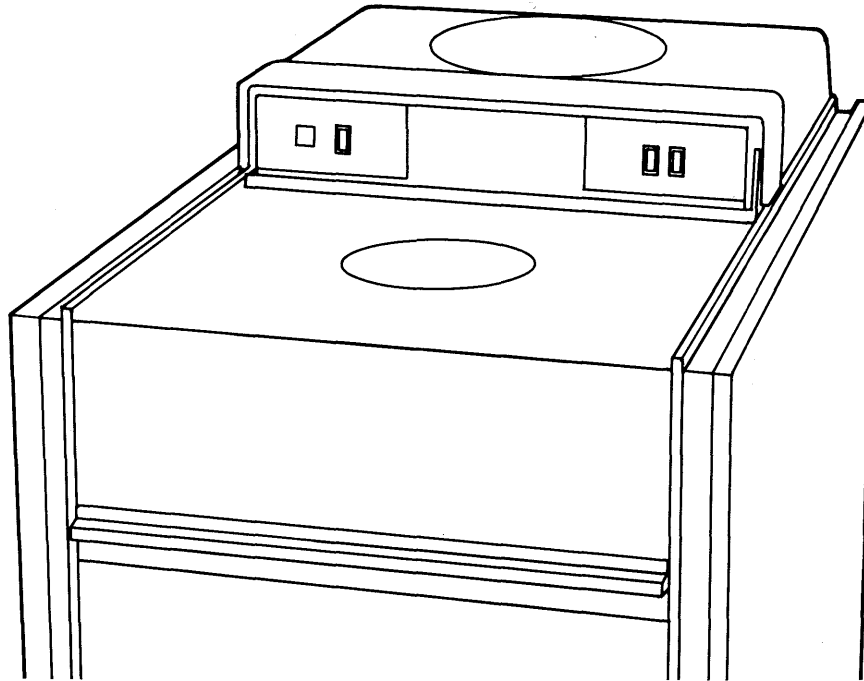

Figure 1.6 Disc pack and drive

DG-25754

Figure 1.7 shows a double-density diskette drive. It holds a flexible, or "floppy," disk and is distinguished from single-density drives by the lamp on its centrally located latch. Its power and unit-select features vary and are explained later in this chapter. The drive can be packaged with others of its type, with a fixed-disk drive (see Figures 1.4 and 1.5), or with both. Each diskette unit corresponds to NOVA/ECLIPSE model 6097 and Microproducts model 6096 drives.

Figure 1.8 shows a single-density diskette drive. It holds a flexible disk and can be packaged with a cartridge disk drive (see Figure 1.6) or with other drives of its type. This drive corresponds to NOVA/ECLIPSE model 6030 and Microproducts model 6038. Variations in power and unit-select features are discussed later in this chapter.

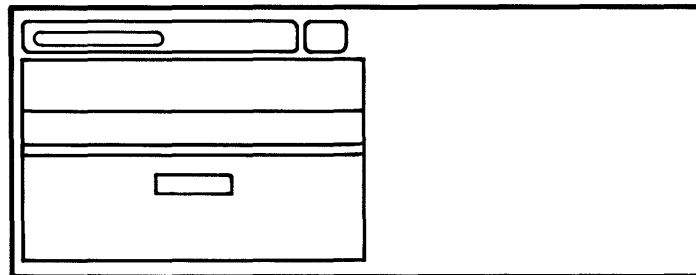

Figure 1.7 Double-density diskette drive

DG-25756

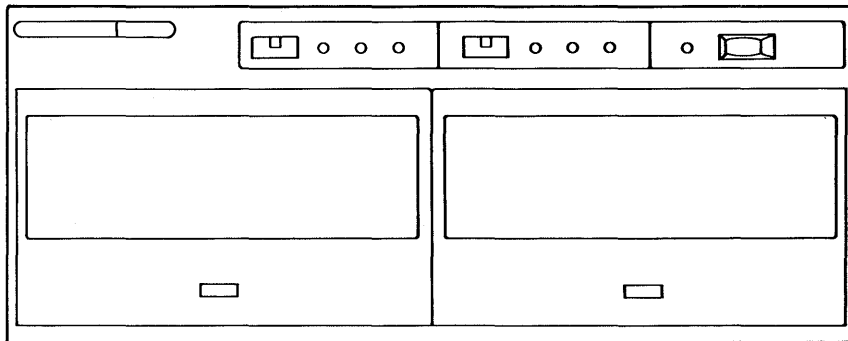

Figure 1.8 Single-density diskette drive

DG-25755

Device Combinations

Among the peripheral units that make up your installation, you must identify a combination of at least two: one unit to hold your release medium and the other to hold your master disk. This discussion assumes you have one of the following four combinations of units:

1. A fixed-disk and double-density diskette drive.
2. A cartridge disk and single-density diskette drive.
3. A disk pack subsystem and diskette drive.
4. A magnetic tape unit and either a fixed-disk drive, a cartridge disk drive, or a disk pack subsystem.

Table 1.4 shows NOVA/ECLIPSE disk and diskette drive combinations.

Table 1.5 shows Microproducts disk and diskette drive combinations, which some ECLIPSE computers support.

Model	Description	Configuration
Fixed-disk and diskette drive combinations		
6001-6008	Fixed NOVADISK drives with fixed-head technology and .26-Mbyte to 1.5-Mbyte storage capacities.	Four drives allowed per controller. Other disk and diskette drives must be configured on separate controller.
6063 6064	Fixed-disk drives with fixed-head technology and storage capacities of 1 Mbyte and 2 Mbytes, respectively.	Four drives in any combination allowed per controller. Other disk and diskette drives must be configured on separate controller.
6097	Double-density diskette drive with 1.2-Mbyte storage capacity.	Four drives allowed per controller. One of these drives can be model 6099 or 6103.
6099	Fixed-disk drive with moving-head technology and 12.5-Mbyte storage capacity. ¹	One model 6099 hard-disk and three diskette drives (model 6097) allowed per controller.
6103	Fixed-disk drive with moving-head technology and 25-Mbyte storage capacity. ²	One model 6103 hard-disk and three diskette drives (model 6097) allowed per controller.
6160-6161	Fixed-disk drives with moving-head technology and 73-Mbyte and 147-Mbyte storage capacities, respectively.	Two drives of either model or one of each allowed per controller. Other disk and diskette drives must be configured on separate controller.
6225 6227	Fixed-disk drives with moving-head technology and 5-Mbyte and 15-Mbyte storage capacities, respectively.	One model 6225/7 hard-disk and one diskette drive (model 6097) allowed per controller.
6234	Fixed-disk drive with moving-head technology and 50-Mbyte storage capacity.	One hard-disk and three diskette drives (model 6097) allowed per controller. Other disk and diskette drives must be configured on separate controller.

Table 1.4 NOVA/ECLIPSE disk and diskette drive combinations

¹ Model 6098 (a variation of Model 6099) is also supported by RDOS. It offers 12.5 Mbytes of hard-disk storage along with a double-density diskette drive.

² Model 6100 (a variation of Model 6103) is also supported by RDOS. It offers 25 Mbytes of hard-disk storage along with a double-density diskette drive.

Model	Description	Configuration
Cartridge disk and diskette drive combinations		
4047	Cartridge disk drive with moving-head technology and 2.5-Mbyte storage capacity.	Four drives in any combination allowed per controller. Other disk or diskette drives must be configured on separate controller.
4234	Cartridge disk drive with 10-Mbyte storage capacity.	Four drives allowed per controller. Can be configured with diskette drives (model 6030) on same controller.
6030	Single-density diskette drive with 3-Mbyte storage capacity.	Four drives allowed per controller. Can be configured with cartridge models 6045 or 4234 on same controller.
6045	Cartridge disk drive with one fixed and one removable platter, moving-head technology, and 10-Mbyte storage capacity.	Four drives allowed per controller. Can be configured with diskette drives (model 6030) in any combination on same controller.
6070	Cartridge disk drive with one fixed and one removable platter, moving-head technology, and 20-Mbyte storage capacity.	Four drives allowed per controller. Other disk and diskette drives must be configured on separate controller.

Table 1.4 NOVA/ECLIPSE disk and diskette drive combinations (continued)

Model	Description	Configuration
Freestanding disk (pack) drives		
6060	Freestanding drives for removable disk packs with moving-head technology and 96-, 190-, and 50-Mbyte storage capacities, respectively.	Four drives in any combination allowed per controller. Other disk and diskette drives must be added on separate controller.
6061		
6067		
6122	Freestanding drive for removable disk pack with moving-head technology and 277-Mbyte storage capacity.	Four drives, including models 6067, 6060, and 6061, allowed per controller. Other disk and diskette drives must be configured on separate controller.
Double-density diskette drive combinations		
6097	Double-density diskette drive with 1.2-Mbyte storage capacity.	Four drives allowed per controller. Can be configured with one model 6226, 6227, 6099, or 6103 fixed-disk drive on same controller.
Single-density diskette drive combinations		
6030	Single-density diskette drive with .3-Mbyte storage capacity.	Four drives allowed per controller. (Two of these drives are also packaged together as model 6031.) Can be configured with model 6045 or 4234 cartridge drives on same controller.

Table 1.4 NOVA/ECLIPSE disk and diskette drive combinations (continued)

Model	Description	Configuration
Fixed-disk and diskette drive combinations		
6096	Double-density diskette drive with 1.2-Mbyte storage capacity.	Four drives allowed per controller.
6102	Fixed-disk drive with 12.5-Mbyte storage capacity. ¹	Three model 6096 drives can be added on same controller. (Also packaged with one model 6096 drive, as model 6101.)
6105	Fixed-disk drive with 25-Mbyte storage capacity. ²	Three model 6096 drives can be added on same controller.
6220	Fixed-disk drive with 5-Mbyte storage capacity.	One model 6096 drive can be added on same controller.
6222	Fixed-disk drive with 15-Mbyte storage capacity.	One model 6096 drive can be added on same controller.
Cartridge disk and diskette drive combinations		
6095	Cartridge disk drive with 10-Mbyte storage capacity.	One drive allowed per controller. Diskette drives must be configured on separate controller.
Double-density diskette drive combinations		
6096	Double-density diskette drive with 1.2-Mbyte storage capacity.	Four drives allowed per controller. Can be configured with one model 6220, 6222, 6102, or 6105 fixed-disk on same controller.

Table 1.5 Microproducts disk and diskette drive combinations.

¹ RDOS also supports Model 6101, a combination of the 12.5-Mbyte hard disk and 1.2-Mbyte diskette drive.

² RDOS also supports Model 6104, a combination of the 25-Mbyte hard disk and 1.2-Mbyte diskette drive.

The steps you take to ready your device combination and identify it to the system generation programs will depend on whether the controllers and power supplies are separate or shared; whether the unit selection features are internal or external; and on which of the units in a multiple drive are designated the primary and secondary units. These variables are discussed below.

A *controller* is a printed-circuit (PC) board wired to supervise peripheral devices. Most NOVA, ECLIPSE, and Microproducts configurations allow two controllers to supervise four units apiece. One exception is the configuration of fixed disks in the 6200 series, which allows a maximum of two controllers to supervise only one hard disk and one double-density diskette drive each. Tables 1.6 and 1.7, shown later, include other exceptions as well.

Generally, devices that share a controller are of the same model, series, or type. Disk and magnetic tape units never run on the same controller, nor do freestanding (disk pack) and flexible (diskette) drives. However, when two types of disk drive are packaged together, the same controller governs both. Tables 1.4 and 1.5. describe these exceptions.

A *power supply* can power one or more drives. The most obvious clue to a unit's power source is the presence or absence of a power switch on its front panel. When a hard-disk drive and diskette drive share one supply, the switch on the disk drive controls both units. A pair of diskette units can also share one supply and switch. Magnetic tape units always draw on a separate power source.

Unit selection refers to the assignment of a unique number to every drive that a controller supervises. Unit-select numbers always start at 0 and increase by one for each subsequent drive. Thus, if a device combination allows two controllers to supervise four drives apiece, the drives on the first controller will be numbered 0 through 3, while the drives on the second controller will be numbered 4 through 7. In this way, a controller can select one drive from among several wired to the same board for a data seek or transfer operation.

During system loading and generation, you will work with two drives, one of which holds your release tape or diskette and the other, your master disk. Generally, these drives will be numbered 0 if they run on separate controllers or 0 and 1 if they share a controller.

To number your drives, you use a thumbwheel knob on the front panels of some magnetic tape, cartridge disk, and single-density diskette units, or a toggle switch on or behind the front panels of fixed-disk units. Where a fixed-disk drive and diskette drive are packaged together, the toggle switch assigns a number to both. A drive that has no external unit-select feature and does not share one with another drive is said to be "hard-wired"; that is, its unit number has already been selected by the wiring of certain jumpers on its controller.

A *primary unit* is the unit with the lowest number on a controller. Thus, if a configuration allows two controllers to supervise four devices apiece, drive 0 is the primary unit on the first controller, and drive 4 is the primary unit on the second.

A *secondary unit* is the one whose unit-select number is second-lowest among those governed by one controller. Thus, if a configuration permits two controllers to supervise four devices apiece, the secondary unit is drive 1 on the first controller and drive 5 on the second.

Device Identifiers

As manager of your system's resources, the operating system must also be able to recognize your devices and the type of CPU on which they run. For this reason, you will be asked to supply three forms of hardware identification: a device code, a device model number, and a unit name.

A *device code* is a 2-digit number that identifies the controller for a particular device. You will supply this number (or a 6-digit counterpart) when you initiate a loader program.

A *device model number* indicates the type of CPU on which this device runs. You supply this number to the disk initializer program, DKINIT.

A *unit name* is a mnemonic composed of two letters followed by a single numeral, for example, DE0. The letters specify a certain type of device, such as a hard disk, single-density diskette, or magnetic tape drive. (Device mnemonics can change depending upon the computer system. The mnemonic DH, for example, represents a cartridge drive in the Microproducts line, while the mnemonic DP signifies the NOVA/ECLIPSE version of this device.) The number in the unit name distinguishes the device from others on the same controller. You supply a unit name to the bootstrap, disk initializer, and starter system programs.

Table 1.6 lists the symbols that identify NOVA and ECLIPSE disk and diskette drives. Table 1.7 lists the symbols that identify Microproducts disk and diskette drives.

Model	Description	Device Code	Controller	Unit Name
6030	Single-density diskette drive with .3-Mbyte storage capacity.	33	1	DPO/1/2/3
		73	2	DP4/5/6/7
6097 ²	Double-density diskette drive with 1.2-Mbyte storage capacity.		Same as above	
6099 ¹	Fixed-disk drive with 12.5-Mbyte storage capacity.		Same as above	
6103 ¹	Fixed-disk drive with 25-Mbyte storage capacity.		Same as above	
6234 ¹	Fixed-disk drive with 50-Mbyte storage capacity.		Same as above	
6225 ²	Fixed-disk drive with 5-Mbyte storage capacity.	33	1	DP0/1
		73	2	DP4/5
6227 ²	Fixed-disk drive with 15-Mbyte storage capacity.		Same as above	
6063	Fixed-disk drive with 1-Mbyte storage capacity.	26	1	DS0/1/2/3
		66	2	DS4/5/6/7
6064	Fixed-disk drive with 2-Mbyte storage capacity.		Same as above	
6160 ⁴	Fixed-disk drive with 73-Mbyte storage capacity.	27	1	DZO/1
		67	2	DZ4/5
6161 ⁴	Fixed-disk drive with 147-Mbyte storage capacity.		Same as above	
6070	Cartridge disk drive for one fixed and one removable platter with 20-Mbyte total storage capacity.	33	1	DPO/1/2/3 and DP0F/1F/2F/3F ³
		73	2	DP4/5/6/7 and DP4F/5F/6F/7F ³

Table 1.6 Device identifiers, NOVA/ECLIPSE disk and diskette drives

Model	Description	Device Code	Controller	Unit Name
6045 ³	Cartridge disk drive for one fixed and one removable platter with 10-Mbyte total storage capacity.	33	1	DP0/1/2/3 and DPOF/1F/2F/3F ³
		73	2	DP4/5/6/7 and DP4F/5F/6F/7F ³
4234	Cartridge disk drive for one fixed and one removable platter with 10-Mbyte total storage capacity.	33	1	DP0/1/2/3 and DP0F/1F/2F/3F ³
		73	2	DP4/5/6/7 and DP4F/5F/6F/7F ³
4047	Cartridge disk drive with 2.5-Mbyte total storage capacity.	33	1	DP0/1/2/3
		73	2	DP4/5/6/7
6122	Moving-head disk drive with 20-surface pack and 277-Mbyte storage capacity.	27	1	DZO/1/2/3
		67	2	DZ4/5/6/7
6060	Moving-head disk drive with 20-surface pack and 96-Mbyte storage capacity.		Same as above	
6061	Moving-head disk drive with 20-surface pack and 190-Mbyte storage capacity.		Same as above	
6067	Moving-head disk drive with 6-surface pack and 50-Mbyte storage capacity.		Same as above	

Table 1.6 Device identifiers, NOVA/ECLIPSE disk and diskette drives (continued)

¹ Only one fixed-disk drive per controller is allowed. A cartridge disk drive cannot share the same controller.

² Only one model 6097 and one model 6225 or 6227 drive are allowed on the same controller.

³ Unit names ending in 'F' indicate the fixed portion of the cartridge disk.

⁴ For use with NOVA 4 and Commercial ECLIPSE systems only.

Model	Description	Device Code	Controller	Unit Name
6102 ¹	Fixed disk drive with 12.5-Mbyte storage capacity.	26	1	DE0/1/2/3
		66	2	DE4/5/6/7
6105	Fixed disk drive with 25-Mbyte storage capacity.		Same as above	
6096 ²	Double-density diskette drive with 1.2-Mbyte storage capacity.		Same as above	
6220 ¹	Fixed disk drive with 5-Mbyte storage capacity.	26	1	DE0/1
		66	2	DE2/3
6222 ¹	Fixed-disk drive with 15-Mbyte storage capacity.	26	1	DE0/1
		66	2	DE2/3
6095	Cartridge disk drive for one fixed and one removable disk with 10-Mbyte total storage capacity.	27	1	DH0, DH0F ³
		67	2	DH1, DH1F ³

Table 1.7 Device identifiers, Microproducts disk and diskette drives

¹ Only one fixed-disk drive per controller is allowed.

² Only one model 6096 and one model 6220 or 6222 drive are allowed on same controller.

³ Unit names ending in 'F' indicate the fixed portion of the cartridge disk.

Getting Started

This section explains how to prepare your hardware for system generation; how to use the virtual and system console keys in your dialogue with various programs; and how to use this book.

Readying Your Hardware

Before commencing the loading and generating procedures, you must do the following:

1. Number your drives.
2. Mount the release tape, if any.
3. Insert the release diskette, if any.
4. Insert any removable hard disk.

These steps are described below for each possible hardware combination. Instructions for powering up your hardware are also given. Study the instructions before executing them and consult the operator's manual (014- series) that accompanied your hardware for full details.

Magnetic Tape and Disk

The following instructions apply to users who received RDOS software on magnetic tape.

1. Locate the thumbwheel unit-select knob, if any, on the front panel of the tape unit. Set this knob to 0, and make sure that no other tape unit corresponds to this number.
2. A plastic ring fits into a groove on the reel of magnetic tape. This is the write-enable ring; it allows data to be written to the tape when it is present and prevents the accidental loss of data when it is not. If this ring is present, discard it.
3. Mount and thread the tape. (A small diagram on the front panel of the unit illustrates the mounting of a tape.)
4. Using the switches on the control panel, turn power on, press LOAD or BOT, and put the unit on line. The READY, WRITE-LOCK, and BOT lamps should light up as a result.
5. Prepare your fixed, cartridge, or free standing disk drive according to one of the subsections that follow.
6. Proceed to the section entitled "Powering Up."

Fixed Disk and Diskette

The following instructions apply to users who are generating an RDOS system on a fixed disk from software received on diskette. Users with a magnetic tape and fixed disk drive combination should execute steps 2 or 3 only.

1. Locate the diskette drive labeled DE0 (Microproducts) or DP0 (NOVA/ECLIPSE) on the first controller or the drive marked DE4 or DP4 on the second. If a unit-select knob is featured, dial the appropriate unit number (0 or 4). If the drive has a power switch, turn it on.
2. Move to the fixed-disk drive and examine its control cluster. If a metal unit-select switch is visible, complete this step; otherwise, skip to step 3. Set the unit-select switch to the SWP position if you are loading software from a diskette drive on the same controller. Otherwise, set this switch to the position labeled NRM. Turn power on to the drive and proceed to step 4.
3. Locate the two clips on either side of the front panel and pull downward to release them. Then remove the front panel and examine the sheet metal for a small slot containing two toggle switches. If you are loading software from a diskette drive on the same controller, flip the right-hand switch to the position marked DSK1/FPY0. Otherwise, set this switch to the position marked DSK0/FPY1. Leave the front panel off temporarily and apply power to the drive.
4. Remove the release diskette from its paper storage envelope; its contents should already be labeled. Cover the write-protect hole on the first diskette with opaque tape. Open the diskette drive door by pressing its centrally located latch. Slide the diskette into the drive with its label facing up and out, as shown in Figure 1.9. The diskette should slide in smoothly and come to a positive stop in the drive. Close the drive door so that it latches shut.
5. Proceed to the section entitled "Powering Up."

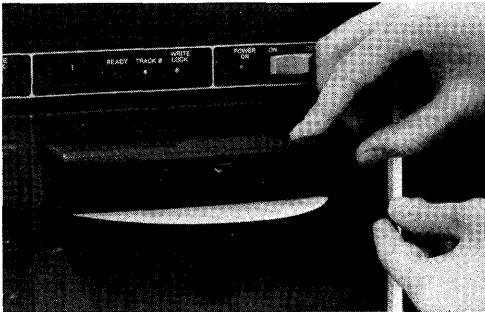

Figure 1.9 Inserting a diskette

PH-0066

Cartridge Disk and Diskette

The following instructions apply to users who are generating an RDOS system on a cartridge disk from software received on single-density diskettes. Steps 3 through 10 also apply to users with magnetic tape and cartridge disk drive combinations.

1. Locate the diskette drive labeled DP0 on the first controller or DP4 on the second. If it has a thumbwheel unit-select knob, dial the appropriate unit number (0 or 4). Turn the power switch on.
2. Remove the STARTER diskette from its paper storage envelope; its contents should already be labeled. Cover the write-protect hole with opaque tape. Open the door of the diskette drive by depressing the latch below it. Slide the diskette into the drive with its label facing up and out, as shown in Figure 1.9. The diskette should slide in smoothly and come to a positive stop in the drive. Close the drive door so that it latches shut.
3. Now move to the cartridge disk drive. Dial 1 on the unit-select knob if one is present and you are working with cartridge model 6045 and software received on diskette. Otherwise, set the unit-select knob, if any, to 1. Power up the drive; flip its LOAD/READY switch to LOAD; and wait for the LOAD indicator to light up.
4. Still working with the cartridge disk drive, locate the latches on either side of its front panel and release them. Slide the drive out of the cabinet until it comes to a stop. (See Figure 1.10, steps A and B.)
5. Remove the dust cover from the cartridge by sliding the latch plate on its handle to the left. (See Figure 1.10, step C.)
6. Holding the handle upright, lift the cartridge up and out of the dust cover. (See Figure 1.10, step D.)
7. Still holding the cartridge by the handle, lower it into the drive cavity, rotating it until it catches in the drive. Then lower the handle to its former position. (See Figure 1.10, steps E and F.)
8. Place the dust cover over the cartridge, making sure that it fits properly, and slide the drive back into the cabinet until it latches securely into place. (See Figure 1.10, step G.)
9. Set the LOAD/READY switch to READY and wait for the READY indicator to light up.
10. Proceed to the section entitled "Powering Up."

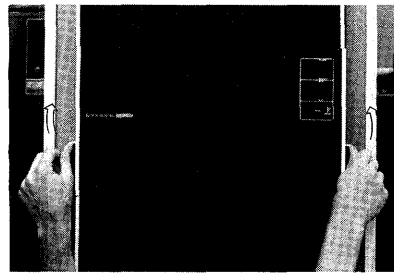

A
Release the latches

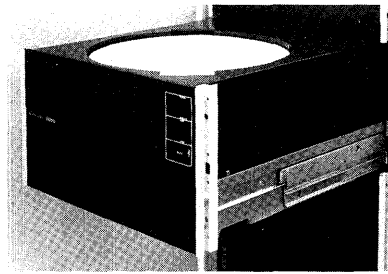

B
Slide the drive out

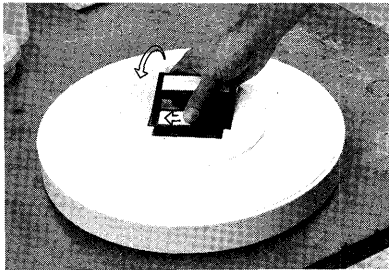

C
Slide latch plate left

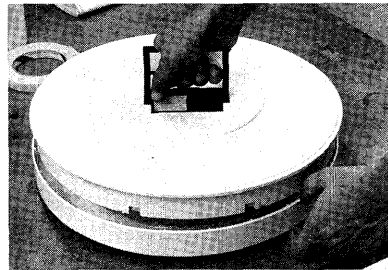

D
Lift cartridge away from dust cover

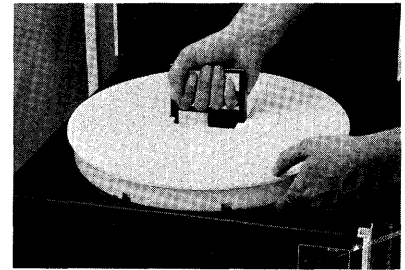

E
Lower cartridge into drive

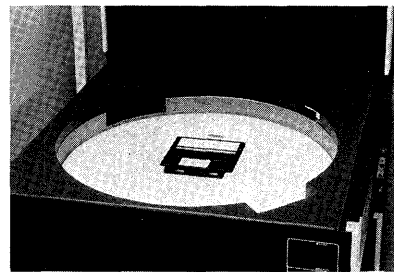

F
Flatten the cartridge handle

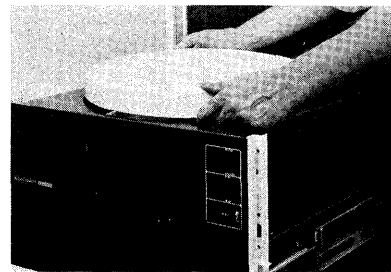

G
Replace the dust cover

Figure 1.10 Loading a cartridge disk

DG-25757

Disk Pack and Diskette

The following instructions apply to users who are building an RDOS system on a pack of disks from software received on diskette. Steps 3 through 9 also apply to users with magnetic tape and disk pack combinations.

1. Locate the primary diskette drive (labeled DP0 or DE0 on the first controller; DP4 or DE4 on the second). If the drive has a thumbwheel unit-select knob, dial the appropriate unit number (0 or 4). Turn the power switch on.
2. Remove the single-density STARTER or double-density ("quad") RDOS release diskette from its paper storage envelope; its contents should already be labeled. Cover the write-protect hole with opaque tape. Open the diskette drive door by depressing its central (double-density) or lower (single-density) latch. Slide the diskette into the drive with its label facing up and out, as shown in Figure 1.9. The diskette should slide in smoothly and
3. Now move to the disk drive adapter and turn its power switch on. Look for the AC MAIN and DC SERVO switches at the rear of the disk drive and set them to the on (up) position. Then turn to the control cluster on the front panel of the drive. The unit indicator should show the number 0; the DRIVE switch should be in the position marked STOP; and the DC POWER switch should be off.
4. Open the loading door by pressing the latch. Make sure that the spindle is motionless and that heads and brushes are retracted. (See Figure 1.11, step A.)
5. Remove the bottom cover of the disk pack by pressing together its two bars and pulling the cover away. Take care not to damage the underside of the pack. (See Figure 1.11, step B.) The bottom cover can be stored in the

come to a positive stop in the drive. Close the drive door so that it latches shut.

area designed to hold it on the upper rear deck of the drive.

6. Lift the disk pack by the handle on its top cover and carefully place it on the spindle. Then turn the handle clockwise, slowly, until it stops. (See Figure 1.11, step C.)
7. Lift the top cover straight up and off of the disk pack and place it on the bottom cover. Avoid touching the recording surfaces.
8. Close the loading door securely. Then turn DC POWER on; set the DRIVE switch to START; and wait for the CHECK and READY indicators to light up.
9. Proceed to the section entitled "Powering Up."

Powering Up

The following instructions apply to all users, regardless of hardware configuration.

1. Check that all equipment is plugged in securely.
2. Make sure that power is on to your device units (disk, diskette, and tape) and that their READY or LOAD indicators, if any, are lit.
3. Turn on power to your CRT or hard-copy terminal.

If your terminal has a LINE/LOCAL switch set it to the LINE position. If your terminal has an ON LINE key, press it so that its indicator lights up. The LINE/LOCAL switch is located on or behind the console; the ON LINE key is next to the space bar on the keyboard.)

Press the VIEW MODE switch on a DASHER hard-copy terminal to verify user input.

Some system generation programs accept uppercase input only. If your console sends both upper- and lowercase input, place it in ALPHA LOCK mode.

4. Power up your computer by placing its power switch in the ON or RUN position.



A
Open the loading door

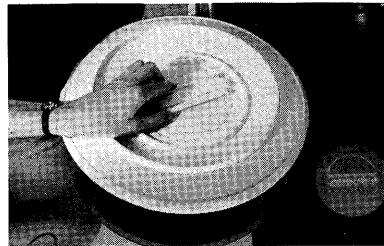

B
Remove the bottom cover from the pack

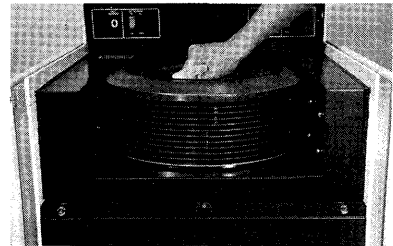

C
Place pack on spindle and turn handle clockwise

Figure 1.11 Loading a disk pack

Using the Console Aids

During your dialogue with the system generation programs, you may want to modify your input or the activity of your console. Function keys and control characters enable you to do so.

A function key is coded to perform a special operation for your console. A control character is an alphabetic key whose code—and function—is altered when it is pressed and released with the CTRL key. CTRL-*x*, designates a CTRL key and character combination, for example, CTRL-A.

Table 1.8 lists the console aids that can be used in your dialogue with the RDOS system software.

Table 1.9 lists the console aids that can be used in your dialogue with the virtual console, if you have this hardware option.

Console Aid	Function
ALPHA LOCK	This key places all alphabetic characters in uppercase until it is pressed a second time. ALPHA LOCK is a toggle key: it turns a function on and off.
CR	The Carriage Return key. This key functions as a terminator on all terminals but the DASHER D100 and D200. Typed after a command line or statement, it signals the executing program to process your input.
CTRL-A	This control character halts the execution of a command or statement and returns you to the program you are running at the time.
CTRL-S	This control character suspends the display of data at your console.
CTRL-Q	This control character resumes the display of data at your console after the display has been suspended by CTRL-S.
DEL or RUBOUT	When depressed on video display terminals, this key erases the character preceding the cursor and moves the cursor to the newly vacated position. On hard-copy terminals, it echos a backarrow or underscore, indicating that the previous character has been deleted.
NEW LINE	This key functions as a terminator on DASHER D100 and D200 terminals only. Typed after a command line or statement, it signals the executing program to process your input.

Table 1.8 Console aids recognized by system software

Console Aid	Function
ALPHA LOCK	This key places all alphabetic characters in uppercase until it is pressed a second time. The virtual console recognizes, but does not require, the use of this console aid because it accepts both upper- and lowercase input.
BREAK	This key stops all software execution. After you strike it, an exclamation point (the virtual console prompt) appears on your console. Type P to return to the program you were running.
DEL or RUBOUT	When depressed on video display terminals, this key erases the character preceding the cursor and moves the cursor to the newly vacated position. On hard-copy terminals, it echos a backarrow or underscore, indicating that the previous character has been deleted.
H ¹	This key, when preceded by an octal device code, causes the hardware to execute a program load from a data channel device. The device code can range from 0 to 76 octal.
K	This key cancels an entire line of input. The virtual console interprets the key after you press it. No new line, carriage return, or other terminator is required.
L	This key, when preceded by an octal device code, causes the hardware to execute a program load from a programmed I/O device. The device code can range from 0 to 76 octal.

Table 1.9 Console aids recognized by the virtual console

¹The virtual consoles of NOVA 4 and ECLIPSE S/140 computers do not recognize the H function.

Charting Your Course

Now, with your hardware prepared, you are ready to load and generate the Real-time Disk Operating System. The chapters ahead guide you through every step of this process, and this section explains how to use them.

The chapters describe three types of procedures: system loading, generation, and maintenance.

System loading. The tasks of initiating a loader program, running the disk initializer, installing a bootstrap root, installing the starter system, and loading the utilities fall within this area and are the subjects of Chapter 2.

System generation. Chapter 3 assists you in building a tailored RDOS system.

System maintenance. Once a system has been loaded and generated, you must perform the tasks of bootstrapping and

releasing it, of accessing new disks, of backing up files, and of patching and tuning the system throughout its life. Chapter 4 covers these topics, and Chapter 5 explains how DKINIT, the stand-alone disk initializer program, aids system maintenance and expansion.

Chapters 2 and 3 step first-time users of RDOS through each of the system load and generation procedures. The figures at the end of these chapters summarize the procedures for more experienced users who need to review them.

Appendix A explains the functions of your RDOS source files and utilities and directs you to the appropriate documentation for more details.

Appendix B interprets error messages from all system load and generation programs except DKINIT and explains how to handle them. (Error messages reported by DKINIT appear in Chapter 5.)

Appendix C contains the ASCII character codes recognized by RDOS and describes the functions of these codes.

Chapter 2

System Loading

This chapter explains how to load your system software from the RDOS release tape or diskette to a master disk. It gives instructions for initiating a loader program, running the disk initializer, installing the bootstrap root and starter system, and loading the utilities. Dialogues with the interactive programs are reproduced to assist you, and Appendix B explains how to handle error messages. The chapter concludes with a summary of software loading procedures.

All discussions assume you have the following hardware and have prepared it according to the instructions in Chapter 1:

- a NOVA or ECLIPSE computer
- a magnetic tape unit or at least one diskette drive
- a fixed, cartridge, or freestanding disk (pack) drive
- a CRT or hard-copy terminal.

Initiating a Loader Program

A loader program brings the first block of system software into the main memory of your computer. This block is part of a bootstrap routine—named `BOOT` on diskette and `TBOOT` on magnetic tape—that enables you to load the disk initializer and starter system.

This section explains how to initiate a loader program with one of these hardware options:

- a virtual console
- automatic program load (APL)
- hardware data switches and APL
- hardware data switches only

The section also discusses common problems and explains what to do if they arise.

Make certain that your computer and devices are powered on and that your system console is on line, with Alpha Lock mode on where applicable, before proceeding. If you are not sure which hardware option applies to your computer, refer to the section entitled “NOVA and ECLIPSE Computers” in Chapter 1.

With the Virtual Console Option

Look for an exclamation point (!) on your system console. This is the virtual console prompt. If it does not appear, flip the computer’s power switch off and on.

The code you must now type in at the console depends on the release medium you are using. Consult Table 2.1 to determine which code to enter.

Release Medium	Virtual Console Entry
NOVA or ECLIPSE diskette on primary controller	100033L
NOVA or ECLIPSE diskette on secondary controller	100073L
ECLIPSE S/280 or Microproducts tape on primary controller	22H
All other tape on primary controller	100022L
Microproducts double-density diskette on primary controller	26L
Microproducts double-density diskette on secondary controller	66L

Table 2.1 Virtual console entries before system generation

The computer now reads `BOOT.SV` from your release diskette, or `TBOOT.SV` from magnetic tape. `BOOT.SV` displays a question on your system console:

```
FILENAME?
```

Type `DKINIT`. The bootstrap routine now reads `DKINIT`, the disk initializer, into memory. Proceed to the section entitled “Initializing Your Master Disk” for information on completing the dialogue with `DKINIT`.

`TBOOT.SV` announces itself with this message:

```
FROM MT0:
```

Type 4. The bootstrap routine now reads `DKINIT`, the disk initializer, into memory. Proceed to the section entitled

“Initializing Your Master Disk” for information on completing the dialogue with DKINIT.

With the APL Option

Place the rocker switch on your computer’s front panel to the PR LOAD position. The computer now reads BOOT.SV from your release diskette, or TBOOT.SV from magnetic tape. BOOT.SV displays a question on your system console:

FILENAME?

Type DKINIT. The bootstrap routine now reads DKINIT, the disk initializer, into memory. Proceed to the section entitled “Initializing Your Master Disk” for information on completing the dialogue with DKINIT.

TBOOT.SV announces itself with this message:

FROM MT0:

Type 4. The bootstrap routine now reads DKINIT, the disk initializer, into memory. Proceed to the section entitled “Initializing Your Master Disk” for information on completing the dialogue with DKINIT.

With Hardware Data Switches and APL

Consult Table 2.2 for the appropriate data switch settings for your hardware.

Release Medium	Data Switch Settings
NOVA or ECLIPSE diskette on primary controller	100033 octal: switches 0, 11, 12, 14, and 15 up; the others down.
NOVA or ECLIPSE diskette on secondary controller	100073 octal: switches 0, 10, 11, 12, 14, and 15 up; the others down.
NOVA or ECLIPSE tape on primary controller	100022 octal: switches 0, 11, and 14 up; the others down.

Table 2.2 Settings for data switches before system generation

When you have set the data switches, lift the RESET switch, followed by the PROGRAM LOAD switch; or, on a SUPERNOVA machine, press CHANNEL START. The computer now reads BOOT.SV from your release diskette, or TBOOT.SV from magnetic tape. BOOT.SV displays a question on your system console:

FILENAME?

Type DKINIT. The bootstrap routine now reads DKINIT, the disk initializer, into memory. Proceed to the section entitled “Initializing Your Master Disk” for information on completing the dialogue with DKINIT.

TBOOT.SV announces itself with this message:

FROM MT0:

Type 4. The bootstrap routine now reads DKINIT, the disk initializer, into memory. Proceed to the section entitled “Initializing Your Master Disk” for information on completing the dialogue with DKINIT.

With Hardware Data Switches Only

Key the switches to a 2-word loader program as follows:

- Set the data switches to 000376 octal by lifting switches 8 through 14 up and pressing the others down.
- Lift the EXAMINE switch and hold it up. The lighted address lamps should correspond to those switches in the up position. Release the switch.
- If you received system software on tape, set the switches to 060122 octal by lifting up switches 1, 2, 9, 11, and 14 and pressing the others down.
- If you received system software on diskette, the data switch settings will depend on whether the diskette unit attaches to the primary or secondary controller. Refer to Table 2.2 for the appropriate settings.
- Lift the DEPOSIT switch and hold it up. The lighted lamps should match those switches in the up position. Release the switch.
- Set the data switches to 000377 octal by lifting switches 8 through 15 up and pressing the others down.
- Depress the DEPOSIT NEXT switch and hold it down. The address lamps should match the switch settings. Release the switch.
- Once more, set the switches to 000376 octal by lifting switches 8 through 14 up and pressing the others down. Lift and release the RESET and then the START switches.

The computer now reads BOOT.SV from your release diskette or TBOOT.SV from magnetic tape. BOOT.SV displays a question on your system console:

FILENAME?

Type DKINIT. The bootstrap routine now reads DKINIT, the disk initializer, into memory. Proceed to the section entitled “Initializing Your Master Disk” for information on completing the dialogue with DKINIT.

TBOOT.SV announces itself with this message:

FROM MTO:

Type 4. The bootstrap routine now reads DKINIT, the disk initializer, into memory. Proceed to the section entitled "Initializing Your Master Disk" for information on completing the dialogue with DKINIT.

Troubleshooting Guidelines

Some troubleshooting may be required if you get no response from BOOT.SV or TBOOT.SV.

If your system software resides on diskette, open the door of the diskette drive and close it firmly; then repeat the program load sequence for your hardware option. If all goes smoothly, proceed.

If nothing happens and you have multiple diskette drives, remove the release diskette and insert it in the adjacent drive. Repeat the program load sequence for your hardware option. If swapping solves the problem, the unit that now houses your release diskette is drive 0, and should be labeled as such.

Finally, if swapping has no effect, return the diskette to its original drive and execute the program load sequence once more. This time, however, assume that the drive is attached to another controller—the secondary controller, for instance, if you assumed the primary controller before—and enter or key the device code accordingly. If your second attempt succeeds, label the diskette drive with the correct device code and unit number.

Initializing Your Master Disk

No disk can hold your system software safely until it has been identified and its surface checked for flaws. These tasks are performed by an interactive disk initializer program called DKINIT. (See Chapter 5 for a full description of DKINIT's functionality.)

This section explains how to use DKINIT to initialize your master disk. Two unbroken dialogues with DKINIT are included in Figures 2.1 and 2.2 at the end of this chapter.

DKINIT responds to invalid entries by displaying an error message and repeating its question. (Chapter 5 explains how to handle DKINIT error messages.) Correct typing mistakes by pressing the DEL or RUBOUT keys to remove characters one by one; DKINIT echos a backarrow, or an underscore, for each character erased. If the program stops responding altogether, turn power to the computer off and on. If applicable, open and close the door of the diskette drive, refer to the section entitled "Initiating a Loader Program"; and repeat all instructions up to this point.

The discussion that follows instructs you in answering DKINIT's questions for the purpose of system loading only. Chapter 5 explains these questions, along with other functions performed by DKINIT, in detail.

Once in memory, DKINIT announces itself and asks for the model number of the drive containing your blank disk.

DKINIT REV 7.10

DISK DRIVE MODEL NUMBER?

If yours is a Model 4234 disk drive, dial 1 on the unit-select knob of the companion diskette drive; flip the disk's LOAD/RUN switch to RUN; and wait for the READY light to glow before proceeding.

All users should then refer to Table 2.3 to determine the appropriate model number of the fixed, cartridge, or free-standing disk drive and enter the number at the console, for example:

6070 (CR)

DKINIT then asks for the unit name of your master disk.

DISK UNIT?

Enter the appropriate unit name from Table 2.3, for example:

DP0 (CR)

Storage Capacity	Model No.	Unit Name	Notes (see below)
Sealed Fixed-Head drives			
.26 Mbytes to 1.5 Mbytes	6001-6008	DK0	1, 2
1 Mbyte	6063	DS0	1
2 Mbytes	6064	DS0	1
Sealed Moving-Head Drives			
12.5 Mbytes	6099	DP1	1, 4
12.5 Mbytes	6102	DE1	3, 4
25 Mbytes	6103	DP1	1, 4
25 Mbytes	6105	DE1	3, 4
73 Mbytes	6160	DZ0	1
147 Mbytes	6161	DZ0	1
5 Mbytes	6220	DE1	3, 4
15 Mbytes	6227	DP1	1, 4
50 Mbytes	6234	DP1	1, 4
Front-loading Cartridge Drives			
2.5 Mbytes	4047	DP0	1
Top-Loading Cartridge Drives			
10 Mbytes	4234	DP0, DP0F	1, 5, 6
10 Mbytes	6045	DP1, DP1F	1, 4, 5
20 Mbytes	6070	DP0, DP0F	1, 5
10 Mbytes	6095	DH0, DH0F	3, 5
Freestanding Disk Pack Drives			
96 Mbytes	6060	DZ0	1
190 Mbytes	6061	DZ0	1
50 Mbytes	6067	DZ0	1
277 Mbytes	6122	DZ0	1

Table 2.3 Disk drive models and unit names

NOTES

¹Device belongs to NOVA/ECLIPSE line.

²Models 6001-6008 are NOVADISKS. Models 6001 and 6005 store 26 Mbytes; models 6002 and 6006 store .52 Mbytes; models 6003 and 6007 store .78 Mbytes; and models 6004 and 6008 store 1.5 Mbytes.

³Device belongs to Microproducts line.

⁴This unit name assumes that the hard-disk enclosure shares the primary controller with a diskette drive. If it does not, specify a unit number of 0 instead of 1.

⁵A unit name ending in 'F' signifies the fixed portion of a cartridge disk. Because the fixed and removable platters are logically distinct, you must run the disk initializer twice—once for each.

⁶Model 4234 has no unit-select feature and is always drive 0 when its ready indicator glows. Thus, the unit-select knob on its companion diskette drive must be set to 0 when loading a program from there lease diskette; adjusted to 1 when initializing the hard disk; and reset to 0 when loading the bootstrap installer from the release diskette into memory.

DKINIT now prompts you for instructions:

COMMAND?

Request a full initialization of your master disk by typing the following:

FULL (CR)

DKINIT issues the following message and then prompts you for the number of test patterns it should run on your master disk.

COMMAND DESTROYS ANY PREVIOUS

RDOS DISK STRUCTURE.

RDOS INITIF MUST BE DONE ON DISK AFTER COMMAND

TYPE CONTROL-A NOW TO ABORT WITHOUT LOSS

NUMBER OF PATTERNS TO RUN (1-5)?

For the most thorough surface analysis possible, type the following:

5 (CR)

DKINIT writes each pattern to every sector on the disk and reads it to ferret out disk blocks that will not retain information. The locations of these blocks are recorded in a bad block table. Depending on the size of the disk, each test pattern can take from 90 seconds to one-half hour or more to complete. You may want to attend to other tasks during this time. If so, wait until the first pattern has run without error. DKINIT displays the following messages after it has successfully completed each pattern. (If you receive an abort message, consult the section entitled "FULL Command" in Chapter 5 for recovery procedures.)

*** PATTERN #1 (155555) ***

*** PATTERN #2 (125252) ***

*** PATTERN #3 (052525) ***

*** PATTERN #4 (000000) ***

*** PATTERN #5 (177777) ***

*** ALL PATTERNS RUN ***

DO YOU WISH TO DECLARE ANY BLOCKS BAD

THAT ARE NOT ALREADY IN THE BAD BLOCK TABLE?

To complete the initialization procedure, answer NO to this question and type a NEW LINE (on DASHER[®] D100 or L200 terminals only) or <CR> after the next three. Your null answer selects the default options for these questions, which pertain to the remap area size, starting block number, and frame size of your master disk.

Keep a record of the default remap area and frame sizes that DKINIT recommends.

DKINIT then sends the following message and prompts you for its next instruction.

FULL DISK INIT COMPLETE

COMMAND?

If your master disk is one of the sealed or freestanding disk pack models, your session with DKINIT is complete. Type the following:

STOP <CR>

Proceed to the next section, "Installing the Bootstrap Root."

If your master disk is one of the top-loading cartridge models (6045, 6095, 6070, or 4234), the fixed portion of this dual-platter disk remains to be initialized. Reinvoke DKINIT by typing the following:

DISK <CR>

Then return to the beginning of this section and repeat the initialization procedures up to this point. Enter the same model number you entered earlier. Where DKINIT asks for a unit name, specify the one from Table 2.3 that corresponds to the fixed portion of your master disk, for example, DP0F. When initialization is complete, type the following:

STOP <CR>

Turn to the next section, "Installing the Bootstrap Root."

Installing the Bootstrap Root

By initializing your master disk, you have readied it to hold its first two blocks of system software—the bootstrap root. As defined in Chapter 1, a loader program brings the bootstrap root into memory, where it instructs the computer to read a bootstrap routine. This routine, in turn, assists a larger portion of operating system software into memory and enables it to execute. Thus, the bootstrap root is a fundamental agent in launching an operating system. Without it, the software on your master disk would have no way of accessing the resources of the computer.

This section explains how to use the installer program to install a bootstrap root on your master disk. An unbroken dialogue with the installer program is included in Figures 2.1 and 2.2 at the end of this chapter.

Invoking the Installer Program

To invoke the installer program, take these preliminary steps.

1. Open and close the door of the diskette drive, where applicable, to position the read/write head at the beginning of your release diskette.
2. Dial 0 on the unit-select knob of the diskette drive if it is accompanied by a Model 4234 cartridge disk. Then turn to the disk drive and flip the LOAD/RUN switch to RUN; wait for the READY lamp to glow before proceeding.
3. Return to the section entitled “Initiating a Loader Program” and repeat the instructions for your hardware option.

Again, the computer reads BOOT.SV from your release diskette or TBOOT.SV from your release tape. BOOT.SV announces itself with the following question:

FILENAME?

Type BOOT to invoke the bootstrap installer

TBOOT.SV identifies itself with this message:

FROM MT0:

Type 5 to invoke the bootstrap installer.

Executing the Installer Program

The installer, named BOOT on both diskette and tape media, announces itself as follows:

BOOT REV 7.10

BOOTSTRAP DEVICE SPECIFIER?

The bootstrap device specifier is the unit name of your master disk. If your master disk is a cartridge disk, you will need the unit names of both its fixed and removable platters. (Enter one unit name at a time; the program loops to ask for the second unit name.) If the cartridge disk is model 4234, dial 1 on the unit-select knob of its companion diskette drive, flip the LOAD/READY switch to RUN, and wait for the READY light before proceeding.

Refer to Table 2.3, for a list of unit names and enter the appropriate one, for example:

DP0 (CR)

INSTALL BOOTSTRAP (Y OR N)?

Signal the installer to execute its task by typing

Y (CR)

The installer program sends a message to inform you that the bootstrap root has been installed, and then loops back to its first question.

DONE.

BOOTSTRAP DEVICE SPECIFIER?

The answer you supply depends on whether your disk is a top-loading cartridge disk and whether you are loading from magnetic tape or diskette.

If yours is a top-loading cartridge disk (models 6045, 6095, 6070, or 4234), you must install a bootstrap root on its fixed platter. Identify the fixed portion of your cartridge disk by entering the appropriate unit name from Table 2.3, for example:

DP0F (CR)

The installer program then asks the following question:

INSTALL BOOTSTRAP (Y OR N)?

Respond with Y. The installer program then announces it has installed the bootstrap root and asks for the unit name of the second platter:

DONE.

BOOTSTRAP DEVICE SPECIFIER?

If you are loading system software from magnetic tape, exit from the installer by pressing the Break key on your keyboard. Then return to the section entitled "Initiating a Loader Program" and execute the steps for your hardware option. As a result of these steps, a message from TBOOT.SV will appear on your display screen:

FROM MT0:

When it does, proceed to the next section, "Installing the Starter System."

If you are loading system software from diskette, consult Table 2.4 and type the name of the unit that houses your release diskette, for example:

DP0 <CR>

(Remember to enter a unit name of DP1 if this drive accompanies model 4234 on the first controller, or DP5 if the two units share the second controller.)

The installer program then asks the following question:

INSTALL BOOTSTRAP (Y OR N)?

Exit from the installer routine by typing N.

Now BOOT.SV comes into memory again and prompts you for a filename, signaling the end of your session with the bootstrap installer. Proceed to the next section, "Installing the Starter System."

Installing the Starter System

As explained in Chapter 1, the starter system is the Real-Time Disk Operating System in an untailed form. This section assists you in transferring the RDOS starter system from magnetic tape or diskette to your master disk. An unbroken dialogue with the starter system and Command Line Interpreter (CLI) appears at the end of this chapter.

Installing From Magnetic Tape

If you are installing the starter system from tape and you have just completed the instructions listed in the section entitled "Initiating a Loader Program," the following message from TBOOT.SV has appeared at your system console.

FROM MT0:

Type 2 to bring the starter system into memory.

Now the starter system asks you to choose between a full and partial initialization and enter the unit name of your master disk. You may recall requesting a full initialization when you invoked DKINIT earlier; the significance of a second initialization, in which the system and map directories are installed, is fully explained in Chapter 5.

FULL (F) OR PARTIAL (P OR <CR>)?

Specify the full initialization by typing

F <CR>

INITIALIZE WHAT DISK?

Enter the unit name of your master disk from Table 2.3, for example:

DP0 <CR>

The RDOS starter system announces itself and then prompts you for the system parameters of date and time as follows:

RDOS REV 7.10

DATE (M/D/Y)?

Enter today's date in the format *month day year*, for example:

12 31 83 <CR>

TIME (H:M:S)?

Enter the current time in hours (*H*), minutes (*M*), and seconds (*S*), where *H* is a double-digit number from 00 to 24 and *M* and *S* are double-digit numbers from 00 to 59. (You can omit the seconds.) If, for example, the time is 4:45 PM, type:

16 45 <CR>

When these parameters have been established, the starter system invokes its Command Line Interpreter, the RDOS CLI. The CLI is an interactive program through which the operating system and its users communicate with one another. The CLI announces itself with the following prompt:

R

This prompt signals that your RDOS system is up and running from your master disk. The starter system save and overlay files are stored under the names BOOTSYS.SV and BOOTSYS.OL. The save, overlay, and error files of the CLI, along with the bootstrap routine BOOT.SV, have also been installed on this disk. You can now proceed to the next section, "Loading the Utilities," and execute the few steps that remain.

Installing From Diskette

If you are installing the starter system from diskette, `BOOT.SV` asks for a filename.

`FILENAME?`

Type `SYS` or a carriage return to invoke the starter system. `SYS` is a file that brings the starter system into memory; transfers the system, `CLI`, and bootstrap routine to disk; and bootstraps the starter system from your master disk.

The starter system comes into message and then prompts you for the unit name of your master disk.

RDOS REV. 7.10

`DISK ID?`

Enter the unit name of the disk from Table 2.3, for example:

`DP0 <CR>`

The starter system then asks you to choose between a full and partial initialization of the disk. You may recall requesting `DKINIT` to initialize your disk earlier. The significance of a second initialization, in which the system and map directories are installed, is fully explained in Chapter 5.

`FULL INIT (Y/N)?`

Type the following:

`Y <CR>`

A few minutes elapse as the starter system is transferred to your master disk. From there, the starter system announces itself and asks you to set the parameters of date and time.

RDOS REV 7.10

`DATE (M/D/Y)?`

Enter today's date in the format *month day year*, for example:

`7 26 83 <CR>`

`TIME (H:M:S)?`

Enter the current time in hours (*H*), minutes (*M*), and seconds (*S*), where *H* is a double-digit number from 00 to 24 and *M* and *S* are double-digit numbers from 00 to 59. (You can omit the seconds.) If, for example, the time is 4:45 PM, type:

`16 45 <CR>`

When these parameters have been established, the starter system invokes its Command Line Interpreter, the `RDOS CLI`. The `CLI` is an interactive program through which the operating system and its users communicate with one another. The `CLI` announces itself with the following prompt:

`R`

The `CLI` prompt indicates that the `RDOS` starter system is up and running from your master disk. Its save and overlay files are stored under the names `BOOTSYS.SV` and `BOOTSYS.OL`, respectively. The save, overlay, and error files of the `CLI`, along with the bootstrap routine `BOOT.SV`, are also stored on this disk. You can now proceed to the next section, "Loading the Utilities," and execute the few steps that remain.

Loading the Utilities

This section explains how to transfer your utilities from diskette or magnetic tape to your master disk. A transcript of this procedure appears at the end of this chapter.

Loading the utilities requires the use of the following `CLI` commands:

- `LOG`. This command records your dialogue in a file named `LOG.CM`.
- `INIT`. When used without the `/F` switch, this command introduces your tape or diskette drive to the starter system.
- `LOAD`. This command transfers previously dumped files from source to destination, that is, from release medium to master.
- `INIT/F`. This command installs a system and map directory on the hard disk.
- `MOVE`. This command copies files from source to destination.
- `RELEASE`. This command closes down a directory in an orderly manner.

For more information on these commands, consult *RDOS/DOS Command Line Interpreter* (DGC No. 069-400015).

Loading From Magnetic Tape

The following instructions assume that you received `RDOS` software on tape; that the starter system is up and running from your master disk; and that the `CLI` prompt appears on your system console.

At the `CLI` prompt, type

`LOG/H <CR>`

to open the log file LOG.CM for recording. The /H switch appends a header to the file. The header contains the name, directory, and date and time of creation of the file.

Identify your tape drive to RDOS by typing

```
INIT MT0 <CR>
```

Copy the utilities from tape to disk with the statement

```
LOAD/V/R MT0:6 <CR>
```

The /V switch causes the CLI to verify each file that it loads at your console, and the /R switch ensures that only the most recent version of a file is stored on the disk.

Copy the system generation program and libraries from tape to disk by typing

```
LOAD/V/R MT0:7 <CR>
```

Disconnect the tape drive from RDOS and rewind it by typing

```
RELEASE MT0 <CR>
```

If your master disk is a cartridge model, issue the INIT/F command followed by the unit name of its fixed platter to install a system and map directory on it, for example:

```
INIT/F DP0F <CR>
```

The following message then appears at the console:

```
CONFIRM? (Y OR N)
```

Type Y to verify your request.

Again, if your disk is a cartridge model, issue the MOVE command followed by the name of its fixed platter and the filename BOOT.SV, for example:

```
MOVE/V DP0F BOOT.SV <CR>
```

Finally, close the log file by typing

```
ENDLOG <CR>
```

(Because the RDOS starter system does not support line printers, the file LOG.CM cannot be printed until you have tailored a system according to the instructions in Chapter 3.)

Your master disk now contains all the software needed to build a tailored RDOS system. Use the RESET and UNLOAD switches to remove the tape from its drive. Store the tape safely, without its plastic write-enable ring, and turn off power to the drive. Then turn to the next section

entitled "Summary" and review the procedures outlined in this chapter or proceed directly to Chapter 3 and generate your RDOS system.

If you do not plan to tailor a system at this time, close down the starter system with the RELEASE command followed by the unit name of your master disk, for example:

```
RELEASE DP0 <CR>
```

Later you can bootstrap the starter system directly by executing the instructions in Chapter 4 in the section entitled "Starting Up the System."

Loading From Diskette

The following instructions assume that you received RDOS software on diskette; that the starter system is up and running from your master disk; and that the CLI prompt appears at your system console.

Open the log file LOG.CM for recording by typing

```
LOG/H <CR>
```

The /H switch appends a header to the file. The header contains the name, directory, and date and time of creation of the file.

Identify your diskette drive to RDOS with the INIT command followed by the appropriate unit name from Table 2.4, for example:

```
INIT DP0 <CR>
```

(Remember that the companion diskette of a model 4234 disk is named DP1 on the primary controller, or DP5 on the secondary.)

Diskette Drive Type	Unit Name
NOVA/ECLIPSE single- or double-density drive on first controller ¹	DP0
NOVA/ECLIPSE single- or double-density drive on second controller ²	DP4
Microproducts double-density drive on first controller	DE0
Microproducts double-density drive on second controller	DE4

Table 2.4 Diskette drive names before system generation

¹If this diskette shares the first controller with a model 4234 cartridge drive, the diskette is temporarily named DP1.

²If this diskette shares the second controller with a model 4234 cartridge drive, the diskette is temporarily named DP5.

Use the LOAD command followed by the name of the diskette, a colon, and file number (1) to copy its contents to your master disk, for example:

```
LOAD/V/R DP0:1 (CR)
```

Remove the diskette from its drive and replace it with the diskette numbered 2. Note: Under normal operating conditions, one diskette is never replaced by another until the drive has been released. Again, issue the LOAD command with the same diskette name and new file number (2), for example:

```
LOAD/V/R DP0:2 (CR)
```

If you received more than two release diskettes, remove the second from its drive and replace it with the third. Issue the LOAD command as before, changing only the file number, for example:

```
LOAD/V/R DP0:3 (CR)
```

Repeat this procedure for each of the five or six diskettes that you received, as follows:

1. Remove diskette number 3, replace it with diskette number 4, and type

```
LOAD/V/R DP0:4 (CR)
```

2. Remove diskette number 4, replace it with diskette number 5, and type

```
LOAD/V/R DP0:5 (CR)
```

3. Replace diskette number 5 with diskette number 6, if any, and type

```
LOAD/V/R DP0:6 (CR)
```

Disconnect the diskette drive from RDOS by entering the RELEASE command followed by the appropriate unit name from Table 2.4, for example:

```
RELEASE DP0 (CR)
```

Remove the release diskette from its drive and store it safely. Next, if your master disk is a cartridge model, issue the INIT/F command followed by the unit name of its fixed platter to install a system and map directory on it, for example:

```
INIT/F DP0F (CR)
```

This question then appears at your console:

```
CONFIRM?
```

Type Y to verify your request.

Again, if your disk is a cartridge model, issue the MOVE command followed by the name of its fixed platter and the filename BOOT.SV, for example:

```
MOVE/V DP0F BOOT.SV (CR)
```

Close the log file by typing

```
ENDLOG (CR)
```

(Because the RDOS starter system does not support line printers, the file LOG.CM cannot be printed until you have tailored a system according to the instructions in Chapter 3.)

The hard disk now contains all software needed to generate an RDOS system. Instructions for tailoring RDOS appear in Chapter 3.

Execute the remaining steps only if your master disk has a unit number of 1—that is, if it shares a controller with a diskette drive and is not a cartridge model 4234.

1. Close down the starter system with the RELEASE command followed by the unit name of your master disk, for example:

```
RELEASE DP0 (CR)
```

2. If both disk and diskette drives feature a thumbwheel unit-select knob on their front panels, dial 0 for the disk and 1 for the diskette.

3. If the disk drive is one of the 6200 series and therefore features two toggle switches on its front panel, move the unit-select switch to the position labeled NRM.

4. If no unit-select knob or switch is featured, locate the right-hand toggle switch—labeled DRIVE 0 SELECT—on the hard disk drive whose front panel you removed earlier. Flip this switch to the right, that is, to the DSK0/FPY1 position. Then replace the front panel on the drive.

Having selected the master disk as drive 0, you can now bootstrap the RDOS starter system directly, using the instructions in Chapter 4 in the section entitled “Starting Up the System” as your guide. Now proceed to the next section, “Summary,” and review the procedures outlined in this chapter or turn to Chapter 3 and generate your RDOS system.

Summary

This section summarizes the system load procedures, which include program loading, running the disk initializer, installing the bootstrap root and starter system, and loading the utilities. It is intended as a reference for users who are already experienced with these procedures or who, guided by this chapter, have completed them for the first time.

Figure 2.1 shows an unbroken dialogue between the programs described in this chapter and a user with the following:

- an ECLIPSE S/20 computer
- the virtual console option
- a CRT or hard-copy terminal
- System software on double-density diskette
- A model 6096 diskette drive on the first controller
- A model 6222 fixed-disk drive on the same first controller.

Figure 2.2 shows an unbroken dialogue between the programs described in this chapter and a user with the following:

- a NOVA 4 computer
- the virtual console option
- a CRT or hard-copy terminal
- system software on magnetic tape
- a model 6027 magnetic tape unit on one controller
- a model 6060 disk (pack) drive on a separate, first controller

The dialogues assume that each user has prepared his or her hardware according to the instructions in Chapter 1. Readers whose hardware varies from these specifications should refer to Table 2.5, which describes the differences these readers will encounter in their dialogues and the parts of this chapter that address them.

Procedure	Difference	Reference
Program loading	Device code and/or hardware option	"Initializing a Loader Program" Tables 2.1 and 2.2
Initializing a blank disk	Disk drive model number and unit name; initialization of fixed platter on cartridge disk, if any	"Initializing Your Master Disk" Table 2.3
Installing a bootstrap root	Unit name of hard disk; unit name of diskette, if used; number of runs through program; manner of exit from program	"Installing the Bootstrap Root" Tables 2.3 and 2.4
Installing the starter system	Unit name of hard disk	Table 2.3
Loading utilities	Unit names (disk and diskette, if any); copying BOOT.SV to fixed portion of cartridge disk, if any; changing disk drive number to 0 if it is not 0 already	"Loading the Utilities" Tables 2.3 and 2.4

Table 2.5 Variables in system loading procedures

```

! 26H

FILENAME? DKINIT

DISK INITIALIZER REV 7.10
DISK DRIVE MODEL NUMBER? 6222

DISK UNIT? DE1

COMMAND? FULL

COMMAND DESTROYS ANY PREVIOUS RDOS DISK STRUCTURE
RDOS INIT/F MUST BE DONE ON DISK AFTER COMMAND
TYPE CONTROL-A NOW TO ABORT WITHOUT LOSS

NUMBER OF PATTERNS TO RUN? 5

*** PATTERN #1 (155555) ***

*** PATTERN #2 (125252) ***

*** PATTERN #3 (052525) ***

*** PATTERN #4 (000000) ***

*** PATTERN #5 (177777) ***

*** ALL PATTERNS RUN ***

DO YOU WISH TO DECLARE ANY BLOCKS BAD
THAT ARE NOT ALREADY IN THE BAD BLOCK TABLE? NO

DEFAULT REMAP AREA SIZE IS xx BLOCKS LONG
IT NEEDS TO BE AT LEAST n BLOCKS LONG

REMAP AREA SIZE [TYPE RETURN FOR DEFAULT]? <CR>

REMAP AREA START BLOCK NUMBER [TYPE RETURN FOR DEFAULT]? <CR>

DEFAULT FRAME SIZE IS dd
MIN IS 1 AND MAX IS mmm

DISK FRAME SIZE [TYPE RETURN FOR DEFAULT]? <CR>

FULL DISK INIT COMPLETE

COMMAND? STOP

! 26H

```

```

FILENAME? BOOT

BOOT REV 7.10
BOOTSTRAP DEVICE SPECIFIER? DE1

INSTALL BOOTSTRAP (Y OR N)? Y

DONE.

BOOTSTRAP DEVICE SPECIFIER? DE0

INSTALL BOOTSTRAP (Y OR N)? N

FILENAME? SYS

RDOS REV 7.10
DISK ID? DE1

FULL INIT (Y/N)? Y

MASTER DEVICE RELEASED

RDOS REV 7.10
DATE (M/D/Y)? 6 26 83

TIME (H:M:S)? 15 10
R

LOG/H
R

INIT DE0
R

LOAD/V/R DE0:1
R

LOAD/V/R DE0:2
R

RELEASE DE0
R

ENDLOG
R

RELEASE DE1

MASTER DEVICE RELEASED
R

```

Figure 2.1 Dialogue between system software and user with ECLIPSE S/20 computer, release software on quad diskette, and model 6222 disk

DG-09533

```

! 100022L

FROM MTO: 4

DISK INITIALIZER REV 7.10
DISK DRIVE MODEL NUMBER? 6060

DISK UNIT? DZO

COMMAND? FULL

COMMAND DESTROYS ANY PREVIOUS RDOS DISK STRUCTURE
RDOS INIT/F MUST BE DONE ON DISK AFTER COMMAND
TYPE CONTROL-A NOW TO ABORT WITHOUT LOSS

NUMBER OF PATTERNS TO RUN (1-5)? 5

*** PATTERN #1 (155555) ***

*** PATTERN #2 (125252) ***

*** PATTERN #3 (052525) ***

*** PATTERN #4 (000000) ***

*** PATTERN #5 (177777) ***

*** ALL PATTERNS RUN ***

DO YOU WISH TO DECLARE ANY BLOCKS BAD
THAT ARE NOT ALREADY IN THE BAD BLOCK TABLE? NO

DEFAULT REMAP AREA SIZE IS xx BLOCKS LONG
IT NEEDS TO BE AT LEAST n BLOCKS LONG

REMAP AREA SIZE [TYPE RETURN FOR DEFAULT]? <CR>

REMAP AREA START BLOCK NUMBER [TYPE RETURN FOR DEFAULT]? <CR>

DEFAULT FRAME SIZE IS dd
MIN IS 1, MAX IS mmm

DISK FRAME SIZE? <CR>

FULL DISK INIT COMPLETE

```

```

COMMAND? STOP

! 100022L

FROM MTO: 5

BOOT REV 7.10
BOOTSTRAP DEVICE SPECIFIER? DZO

INSTALL BOOTSTAP (Y OR N)? Y

DONE.

BOOTSTRAP DEVICE SPECIFIER?

! 100022L

FROM MTO: 2

FULL (F) OR PARTIAL (P OR <CR>)? F

INITIALIZING WHAT DISK? DZO

DATE (M/D/Y)? 7 26 83

TIME (H:M:S)? 12 45
R

LOG/H
R

INIT MTO
R

LOAD/V/R MTO:6
R

LOAD/V/R MTO:7
R

RELEASE MTO

MASTER DEVICE RELEASED
R

```

Figure 2.2 Dialogue between system software and user with NOVA 4 computer, release software on tape, and model 6060 disk

DG-09534

System Generation

This chapter explains how to build a tailored RDOS system on a hard disk. It introduces the system generation program; presents instructions for invoking and executing the program; and discusses the procedures for testing a new system. The chapter concludes with several sample dialogues between the system generation program and its users.

All discussions assume that your RDOS starter system—or a system that you generated previously—is up and running from a hard disk numbered drive 0. If you have not yet installed the starter system on disk, read and execute the instructions in Chapter 2. If the starter system is installed but not running, follow the steps under “Starting Up the System” in Chapter 4 and enter the starter system’s name, `BOOTSYS`, when `BOOT.SV` asks for a filename.

Tailoring Guidelines

This section introduces `SYSGEN`, an interactive program that allows you to generate RDOS systems tailored to your hardware and software needs. `SYSGEN` asks you a series of questions about RDOS features and then builds a system to accommodate your specifications. You use `SYSGEN` when

first loading your RDOS system; when devices are added or removed; and when system resources require balancing.

System Optimization

Because `SYSGEN` handles both the hardware and software configurations of your RDOS system, it permits you to manipulate your system’s resources for maximum efficiency. The flexibility offered by `SYSGEN` allows you to fashion an operating system that accommodates the features of your hardware and your particular application, and to refine your operating system as your needs evolve.

For example, if system speed is critical to a mapped RDOS application, `SYSGEN` allows you to make system overlays resident, resulting in fewer attempts to access the disk. In addition, the number of stacks, buffers, directories, and subdirectories can be manipulated to achieve the greatest efficiency and speed for a highly dedicated application.

Table 3.1 shows the amount of memory required by each RDOS feature. To calculate your own memory needs, add the number of words required by the system root to the sum of additional features, in octal words, that your system will use.

Feature	Size						
	URDOS	MRDOS	NRDOS	BRDOS	ARDOS	ZRDOS	TRDOS
System root (runtime) ¹	17334	21555	22205	16653	21471	21674	21710
System root (start-up) ¹	24064	32061	33446	23406	32753	33221	33226
Burst Multiplexor Channel	—	—	—	—	—	30	—
Array processor ²	—	—	—	—	—	2	—
Background channels	—	46	46	—	46	46	46
Foreground channels	—	46	46	—	46	46	46
NOVADISK controllers	305	305	305	301	312	312	—
Second controller	124	124	124	121	121	121	—
6063/6064 disk controller	357	364	364	356	363	374	—
Add per additional controller	142	144	144	137	141	141	—
Add per unit	104	104	104	104	104	104	—
6060/6061/6067/6122 disk controllers	635	640	640	627	642	660	—
Add per additional controller	21	21	21	16	16	16	—
Add per unit	104	104	104	104	104	104	—
Add for error-checking	251	350	342	240	317	317	—
Add if dual-ported (IPB)	123	123	123	123	123	123	—
Other moving-head disk controllers	526	550	550	525	562	562	—
Add per additional controller	20	20	20	15	15	15	—
Add per unit	104	104	104	104	104	104	—
6096/6102/6105/6220/6222 disk controllers	—	—	—	—	—	—	577
Add per additional controller	—	—	—	—	—	—	15
Add per unit	—	—	—	—	—	—	104
6095 disk controllers	—	—	—	—	—	—	—
One controller	—	—	—	—	—	—	656
Two controllers	—	—	—	—	—	—	1107
Bad block pool	6 words per disk plus 2 words per bad block reserved						
Dual processors (IPB) ³	3054	3054	3054	3001	3001	3001	—
Stacks ⁴	2 buffers (416 words) per stack plus:						
	341	341	341	311	311	311	—
Extra cells	20	20	20	20	20	20	20

Table 3.1 System features and corresponding memory requirements

Feature	Size						
	URDOS	MRDOS	NRDOS	BRDOS	ARDOS	ZRDOS	TRDOS
Tuning ⁵	416	416	416	416	416	416	416
Add with overlay report	1034	1034	1034	1034	1034	1034	1034
Extra buffers	416	416	416	416	416	416	416
Each directory or partition (accessible at one time)	60	60	60	60	60	60	60
Controllers for MTA ⁶	1005	1003	1003	1005	1006	1006	1006
Add per additional controller	142	126	126	137	123	123	125
Add per unit	21	21	21	21	21	21	21
Controllers for CTA ⁶	1010	1006	1006	1010	1006	1006	—
Add per additional controller	142	142	142	137	137	137	—
Add per unit	21	21	21	21	21	21	—
Auto restart on power fail	525	543	565	445	472	473	473
Operator messages	336	417	412	336	404	404	404
RTC	0	0	0	0	0	0	0
Paper tape reader	124	124	124	121	121	121	121
Second PTR	105	105	105	105	105	105	105
Paper tape punch	115	115	115	112	112	112	112
Second PTP	76	76	76	76	76	76	76
Line printers							
One standard LPT	174	276	276	171	273	273	273
One data channel LPT	354	472	472	350	465	465	465
Two standard LPTs	351	556	556	346	553	553	553
Two data channel LPTs	535	756	756	531	751	751	751
Two LPTs, one standard and one data channel	531	752	752	525	745	745	745
Card readers	423	423	423	420	420	420	—
Second CDR	311	311	311	311	311	311	311
Incremental plotters	171	171	171	166	166	166	166
Second PLT	152	152	152	152	152	152	152
Multiprocessor communications adapters	633	710	704	633	676	676	—
Add per additional controller	272	272	272	264	264	264	—

Table 3.1 System features and corresponding memory requirements (continued)

Feature	URDOS	MRDOS	NRDOS	Size BRDOS	ARDOS	ZRDOS	TRDOS
QTY (asynchronous data multiplexor, type 4060)	1 word per line plus: 1363	1503	1501	1322	1441	1441	—
ALM or ULM (asynchronous or universal line multiplexor)	2 words per line plus: 1442	1542	1540	1361	1500	1500	1500
Modems ⁷							
With standard timers	1 word per line plus: 102	102	102	102	102	102	102
Without standard timers	70	70	70	70	70	70	70
Second TTY	403	403	403	403	403	403	403
Core dump facility							
Line printer	233	333	336	233	330	330	330
Data channel line printer	233	333	336	233	330	330	330
Diskette	225	240	246	225	234	250	—
Quad diskette	253	266	274	253	262	276	305
Magnetic tape	205	220	226	205	214	230	230

Table 3.1 System features and corresponding memory requirements (continued)

¹The runtime and start-up sizes of the system root include the system initializer and the start-up CLI, named CLIBT. Memory space occupied by the system initializer becomes available to the user's programs after the system starts up. When the start-up CLI chains to its runtime counterpart, the program CLI.SV overwrites CLIBT in memory.

Users of unmapped RDOS should note that proper start-up requires at least 14000 octal or 6144 decimal words of memory for the execution of CLI.SV. (These figures do not include memory for CLIBT or the system initializer.)

²Array processor (AP) memory requires no separate support and only two additional parameters: the starting address and size of AP memory.

³The sizes listed here include four extra cells that SYSGEN adds for this option.

⁴RDOS requires at least one system call stack. SYSGEN reserves space for a minimum of six system buffers, unless the user chooses more than three stacks during system generation. When the user's choice is greater than three, SYSGEN reserves space for twice as many buffers as stacks. Take this into account when calculating the size of an RDOS system containing more than three stacks.

⁵The tuning option does not add any executable code to the resident portion of RDOS. It does, however, force the addition of an extra buffer. SYSGEN adds a total of three extra buffers if the user chooses tuning with overlay reporting.

⁶The magnetic and cassette tape subsystems share a software driver. Only their device tables (controller device control tables [DCTs] and unit extensions) are unique. Add the driver size to the overall size of your system only once if your configuration features both tape subsystems.

⁷If the system is to support an ALM or ULM, but not a modem, add two words to the size of the system.

Once your operating system has been built, you can determine its memory requirements through several means. SYSGEN creates SYS.LM, a load map file that contains the lowest NREL address your system will use. This address is displayed in octal next to the symbol SMON and can be located by opening the load map file with a text editor. By converting the address to decimal and subtracting from it the number of channels opened by your programs multiplied by 38, you will arrive at the maximum words available for user programs.

Alternatively, if yours is a mapped system, you can issue the CLI command GMEM, which returns the number of 2,048-byte blocks available for user programs. This command must be issued after the system has been tailored and bootstrapped into memory.

I/O Devices

SYSGEN accommodates the valid hardware configurations for RDOS systems by asking about each possible device in turn. If your installation does not feature a given device, SYSGEN continues to the next question. When you specify a device, SYSGEN questions you in greater depth about its characteristics.

When you add a new device to your configuration, you must generate a new system that includes the device. In addition, to reduce system overhead, you should run SYSGEN to remove from the operating system any device that you remove from your configuration.

SYSGEN Files

SYSGEN produces the following files and stores them in your working directory. (Your working directory is the hard disk, usually in drive 0, from which your RDOS starter system is currently running.)

- **SYS.SV.** This file contains your tailored RDOS system.
- **SYS.OL.** This file contains the system overlays.
- **SYS.SG.** When invoked with the appropriate command line, SYSGEN reproduces its questions and your answers in this dialogue file, or *script file*. (The next section explains how to invoke SYSGEN.) The script file is a useful record of the devices and features included in your operating system. It can be used in future SYSGEN sessions as a model for system parameters. The SYSGEN examples at the end of this chapter illustrate SYSGEN sessions and are themselves script files.
- **SYS.LM.** When invoked with the appropriate command line, SYSGEN records the location and content of every module of your system save and overlay files. (The next section explains how to invoke SYSGEN.) The resulting record, or load map file, is used to patch your system, as explained in Chapter 4.

SYS is the *default* name for the files created during the disk bootstrapping procedures. You can also identify these files with a unique name consisting of up to 10 characters. The suffixes **.SV**, **.OL**, **.SG**, and **.LM** are appended to the unique name you supply. Remember that whenever two systems are identified by the same name, the existing system is deleted and replaced by the new one. A system is named in the same command line that invokes SYSGEN. The next section entitled "Running the System Generation Program" explains how to issue this command line.

Running the System Generation Program

This section reproduces each SYSGEN question and explains how to answer each one. You will find the answers to some questions obvious and the answers to others less so. Standard replies are recommended if this is your first session with SYSGEN or if you cannot fully anticipate your needs at this time. Later, after your system has been tried and appraised, you can run SYSGEN again to refine its performance.

For each question that it asks, SYSGEN displays the valid answers in parentheses. When you can choose an answer from a range of consecutive numbers, the upper and lower limits of the range are enclosed in parentheses. Each question requires an explicit answer; if you default any question with a New Line or Carriage Return, SYSGEN assumes an answer of 0. Input must be terminated with a New Line on DASHER 100 or 200 terminals or with a Carriage Return on all other terminals. Input can be corrected with the DEL or RUBOUT keys before it has been terminated. In addition, you can interrupt the system generation program at any point and start over by pressing the CTRL and A keys simultaneously (CTRL-A); this action returns you to the CLI, where you can reinvoke SYSGEN with the command line described in the next paragraph. Appendix B explains how to handle error messages.

The following command line brings SYSGEN into memory and tells it to create the system save, dialogue, and load map files described in the previous section. (SYSGEN automatically creates the system overlay file, so there is no need to request one.)

```
SYSGEN SYS.(SV/S SG/V LM/L) (CR)
```

Alternatively, you can supply a descriptive filename in place of **SYS**, for example:

```
SYSGEN SMALLSYS.(SV/S SG/V LM/L) (CR)
```

SYSGEN announces itself with the following message:

```
RDOS SYSTEM GENERATOR REV 7.10  
VALID ANSWERS ARE PRESENTED IN  
PARENTHESES FOLLOWING EACH QUESTION.  
CHOOSE THE APPROPRIATE ONE.
```

Then, after a brief pause, your session with SYSGEN begins.

Processor Type

ENTER PROCESSOR MODEL (CURRENTLY SUPPORTED MODELS

INCLUDE: NOVA NOVA/2 NOVA/3 NOVA/4 NOVA/800 NOVA/820

NOVA/830 NOVA/840 NOVA/1200 S/20 S/120 S/130 AP/130 S/140

C/150 S/200 S/230 S/250 S/250IAP S/280 C/300 C/330 AND C/350):

Enter the processor model on which this RDOS system will run. Because SYSGEN does not ask a separate question for array processors, you must answer AP/130 to support an array processor on your S/130 computer. Similarly, if your S/250 computer features the integral array processor option, enter S/250IAP.

SYSGEN asks the next question only if you answer S/140, S/250(IAP), S/280, or C/350 to this one. If neither the burst multiplexor channel (BMC) or mapped memory options are available with your processor, SYSGEN skips to the questions pertaining to unmapped systems and asks you to supply a number of patch space blocks.

BURST MULTIPLEXOR CHANNEL (BMC)? ("0" = NO "1" = YES)

The BMC is an optional, high-speed data channel interface featured only on ECLIPSE S/140, S/250(IAP), S/280, and C/350 processors. It is used with fixed-head disk models 6063 and 6064; with freestanding models 6060, 6061, 6067, and 6122; and with Winchester-type disk models 6160/6161.

Later, if you answer 1 to this question, SYSGEN asks you to identify those disks attached to the BMC as part of its disk selection dialogue.

Mapped System Requirements

SYSGEN asks the next question only if the mapped memory option is available with your processor and skips the next six questions if it is not.

MAPPED SYSTEM? ("0" = NO "1" = YES)

Answer 1 if your computer has a memory allocation and protection (MAP) unit and you plan to run mapped RDOS on it. Otherwise, answer 0. The next five questions are asked only of users who enter 1 here.

ENTER MEMORY SIZE IN NUMBER OF 1 KW PAGES (NN-MMMM):

Enter the number of 1024-word memory pages present in the target system. (The values SYSGEN displays for NN and MMMM — the minimum and maximum number of pages allowed — vary with the processor model. A 128 Kword memory, for example, is organized into 128 1024-word pages in a mapped system; user with this much memory would therefore answer 128.

SYSGEN skips the next question if you specify less than 48 memory pages or if your processor is a NOVA/830 or NOVA/840.

SYSTEM OVERLAYS RESIDENT? ("0" = NO "1" = YES)

This option preloads all system overlays into the extended memory made accessible by the map feature. Preloading reduces contention for disk access because it eliminates those accesses that are required when system overlays are loaded on an as-needed basis.

Sixteen pages of memory are required to preload system overlays. The option is not recommended for systems with less than 64 pages of memory because the pages remaining may be insufficient to accommodate user programs and the CLI.

SIZE OF SHARED DATA AREA IN PAGES (0-NNN)

This feature allows you to set aside a certain number of memory pages as a shared data area, fully accessible to both the foreground and background. The maximum number of pages allowed for this purpose—represented by NNN—depends on your answer to the previous question and on the total number of memory pages available to you.

MAXIMUM NUMBER OF CHANNELS BACKGROUND WILL USE (1-255)

A channel is a gateway to an input or output device or file. Answer with the maximum number of hardware I/O channels needed to execute your background-mode programs.

If any program addresses channels explicitly, by number, enter the highest decimal number addressed, even if it exceeds the number of channels used. RDOS will not run a program that requests more channels than you specify here, nor will it run a program that addresses a channel with a higher number.

The Command Line Interpreter requires 14 channels; therefore, your new system will not run if you select fewer than 14. Extended BASIC typically requires five channels, along with a number of channels equal to the maximum number of files that can be open concurrently. The COBOL compiler requires a minimum of 25 channels; the RPG compiler uses 27.

If you are unsure of your needs and will not be running COBOL or RPG, enter 16. This answer accommodates most software.

MAXIMUM NUMBER OF CHANNELS FOREGROUND WILL USE (0-255)

Use the previous discussion of background channels to answer this question. (The conditions for determining the number of background and foreground channels are the same.) By entering 0, you forego foreground mode because at least one channel is required to read programs from disk. If unsure of your needs, enter 16.

Unmapped System Requirements

SYSGEN asks the following two questions only of users of unmapped RDOS. If yours is a mapped system, proceed to the section entitled "Disk Drives."

NUMBER OF PATCH SPACE BLOCKS (0-64)?

Patch space—the area where RDOS updates are installed—must be allocated to unmapped systems before they are generated because page 0 is not available for updates. (Mapped RDOS leaves considerable space on page 0 for system updates, but unmapped RDOS shares this space with user programs; therefore, patch space must be reserved elsewhere among the addresses used by unmapped RDOS.) Patch space is allocated in units, or *blocks*, of eight words. Your answer to this question determines the number of 8-word blocks that can be used to update this system later on. Reserve at least five blocks for patch space if you plan to install updates subsequent to revision level 7.00.

MEMORY SIZE IN 1KW INCREMENTS (16-32)?

Enter the amount of memory—in 1024-word increments—available in the computer on which the RDOS system will run. If, for example, your computer has 20,480 words of storage, type 20. Your answer will be used to position the load point of this system in such a way that it occupies the uppermost portion of available address space. In this way, no space is wasted at the top of memory.

Disk Drives

SYSGEN asks you to choose among the several disk configurations possible given the processor that you selected earlier. The program presents one set of options to each user whose processor resides on the 15-in. by 15-in. printed-circuit card that fits into a standard NOVA or ECLIPSE chassis, and offers a unique selection to each user whose processor resides on a 7-in. by 9-in. printed circuit card, which plugs into the Microproducts chassis.

Standard NOVA and ECLIPSE Configurations

The following questions and guidelines apply to users whose processor is housed by a standard NOVA or ECLIPSE chassis. Proceed to the next subsection, "Microproducts Configurations," if yours is not.

NUMBER OF NOVADISK CONTROLLERS (0-2)

A NOVADISK is a sealed, fixed-head model of the 6001-6008 series. Each NOVADISK has its own controller. Enter the number of controllers, or drives, that this RDOS system will support. SYSGEN skips the next question if you enter 0 or 2.

DEVICE PRIMARY ("0") OR SECONDARY ("1")?

Answer 0 if your NOVADISK is wired to the primary controller or 1 if it is wired to the secondary controller. A primary disk has a device code of 20 and the unit name DK0; a secondary disk has a device code of 60 and the unit name DK1.

NUMBER OF 6063/6064 DISK CONTROLLERS (0-2)

Models 6063 and 6064 are newer, sealed fixed-head disks. Each controller can handle up to four drives. Enter the number of 6063/6064 controllers that you plan to include in this RDOS system. SYSGEN skips the two questions that follow if you answer 0. It asks the next question only if you answer 1.

DEVICE PRIMARY ("0") OR SECONDARY ("1")?

Answer 0 if your 6063/6064 controller is connected to the first device code or 1 if it is connected to the second. The primary controller has a device code of 26 and governs the drives named DS0, DS1, DS2, and DS3. The secondary controller has a device code of 66, and governs the drives named DS4, DS5, DS6, and DS7.

NUMBER OF DEVICES FOR CONTROLLER #1 (1-4)

Answer with the number of disk drives connected to the first controller. If you specified two 6063/6064 controllers earlier, SYSGEN repeats this question for the second controller.

NUMBER OF 6060/6061/6067/6122/6160/6161 DISK CONTROLLERS (0-2)

The disk drive models listed here belong to two series of drives designed to hold multiple-platter disk packs. The controller for the 6060/6061/6067/6122 series can handle up to four drives; the controller for the 6160/6161 series handles up to two. Although the disks in both series use the same software driver, they cannot be intermixed on the same controller.

Enter the number of controllers, regardless of the series, that your system will support. SYSGEN asks the next question only if you answer 1 to this one. It skips the next four questions if you answer 0.

DEVICE PRIMARY ("0") OR SECONDARY ("1")?

Answer 0 if the controller has a device code of 27 and governs the drives named DZ0 and DZ1, or DZ0, DZ1, DZ2, and DZ3. Answer 1 if the controller has a device code of 67 and supervises drives DZ4 and DZ5, or DZ4, DZ5, DZ6, and DZ7.

SYSGEN asks the next question only if you answer yes to the "Burst Multiplexor Channel (BMC)?" question asked earlier.

CONTROLLER #1 ON BMC? ("0" = NO "1" = YES)

Answer 1 if your primary controller is attached to the BMC; otherwise, answer 0. SYSGEN returns to this question for the secondary controller if you specified one earlier.

CONTROLLER #1 6160/6161 TYPE? ("0" = NO "1" = YES)

Answer 1 if your primary controller supports disk drive models 6160/6161 or 0 if it does not. SYSGEN returns to this question for the second controller if you specified one earlier.

NUMBER OF DEVICES FOR CONTROLLER #1 (1-4)

or

NUMBER OF DEVICES FOR CONTROLLER #1 (1-2)

SYSGEN asks the first question of users who specified one or more 6060/6061/6067/6122 controllers. (As mentioned earlier, this type of controller handles up to four drives.) The second question applies to users with at least one 6160/6161 controller, which handles up to two drives. Respond with the number of disk drives connected to the first controller. SYSGEN returns to this question for the second controller if you specified one earlier.

NUMBER OF OTHER TYPES OF MOVING-HEAD DISK CONTROLLERS (0-2)

This question covers the disk models supported by standard NOVA and ECLIPSE systems. It includes all sealed moving-head disks, cartridge disk drives, and diskettes. Be sure to specify the number of controllers, not drives, that your RDOS system will support. SYSGEN next asks for the bad block pool size if your answer is 0. It asks the following question only if you answer 1.

DEVICE PRIMARY ("0") OR SECONDARY ("1")

In most cases, the moving-head disk controller is primary and calls for a 0 answer. If you are certain, however, that yours is the secondary controller, answer 1. The primary moving-head disk controller has a device code of 33 and governs the drives named DP0, DP1, DP2, and DP3. The secondary controller has a device code of 73 and supervises drives DP4, DP5, DP6, and DP7.

NUMBER OF DEVICES FOR CONTROLLER #1 (1-4)

Each sealed moving-head disk, each dual-platter cartridge disk subsystem, and each diskette drive counts as one device. Enter the number of drives connected to the first controller.

TOP LOADER(S)? ("0" = NO "1" = YES)

If top-loading model 6045, 6070, or 4234A cartridge disk drives are connected to your first controller, type 1. Your answer identifies to SYSGEN the built-in, nonremovable platter contained in these drives. This nonremovable disk is named DP0F, DP1F, DP2F, or DP3F when connected to the first controller. (The removable disk on this controller has the mnemonic DP0, DP1, DP2, or DP3.)

SYSGEN returns to its previous question and then repeats this one—this time for the second controller, if you specified one earlier. If you did not, SYSGEN next asks you to enter the size of the bad block pool.

Microproducts Configurations

The following questions and guidelines apply to users whose processor is housed by a Microproducts chassis. Refer to the previous subsection, "Standard NOVA and ECLIPSE Configurations," if yours is not.

NUMBER OF 6096/6102/6105/6220/6222 DISK CONTROLLERS? (0-2)

The models listed here belong to two series of fixed moving-head disks. The disks in these two series can be configured with the model 6096 double-density diskette. A controller for disks from the 6100 series can handle up to four drives; the 6200-series controller handles up to two drives. Table 3.2 lists some of the characteristics of disks in both series.

Model	Description	Max. Units per Controller	Unit Names (Controller #1)	Unit Names (Controller #2)
6096	1.2-Mbyte diskette	4	DE0 through DE3	DE4 through DE7
6102	12.5-Mbyte 14-in. Winchester disk	4	DE0 through DE3	DE4 through DE7
6105	25-Mbyte 14-in. Winchester disk	4	DE0 through DE3	DE4 through DE7
6220	5-Mbyte 8-in. Winchester disk	2	DE0, DE1	DE4, DE5
6222	15-Mbyte 8-in. Winchester disk	2	DE0, DE1	DE4, DE5

Table 3.2 Microproducts fixed disks and diskettes

SYSGEN skips the next four questions if you answer 0 to this one.

CONTROLLER #1 6220/6222 TYPE DISKS? ("0" = NO "1" = YES)

Answer 1 if your primary controller supports the 6200-series disks or 0 if it does not.

NUMBER OF DEVICES FOR CONTROLLER #1? (1-4)

or

NUMBER OF DEVICES FOR CONTROLLER #1? (1-2)

SYSGEN asks the first question of users whose first controller governs disks from the 6100 series. It asks the second question of users whose first controller handles 6200-series disks. Each diskette or fixed-disk drive counts as one device. Enter the number of drives attached to your primary controller.

SYSGEN asks you to supply the same information on the secondary controller if you specified one earlier; that is, it loops back to its previous question and then repeats this one.

NUMBER OF 6095 DISK CONTROLLERS? (0-2)

Model 6095 is a top-loading cartridge disk drive containing one fixed and one removable platter. It is similar to the top-

loading model 6045 found in standard NOVA and ECLIPSE configurations; the disk cartridges are interchangeable.

The primary 6095 controller has a device code of 27 and handles one drive, DH0; the mnemonic DH0F identifies its fixed platter. The secondary controller has a device code of 67 and supervises drive DH1 and its fixed platter, DH1F.

Enter the number of 6095 controllers this RDOS system will support.

Software Parameters

This series of questions applies to users of mapped and unmapped RDOS alike. (Only one question—a question on dual processing—is processor-dependent.) This section provides general answers or guidelines for arriving at such answers. Later, you can refine these answers with the tuning feature explained in Chapter 4, if you support this feature.

ENTER BAD BLOCK POOL SIZE IN BLOCKS (0-512)

RDOS needs a bad block pool in memory to pass over unusable portions of a disk. This pool must be large enough to hold bad blocks for all disks in the system. Therefore, if your system supports two cartridge subsystems (a total of four disks) with three flawed blocks on each disk, the bad block pool must contain a minimum of 12 blocks so that all four disks can be initialized at the same time.

Ideally, your calculation for each disk should correspond to the default remap area size that DKINIT assigned to your master disk when you initialized it earlier. If you have forgotten the default size and DKINIT ran all test patterns without error, assume you need 12 blocks for each small or medium-sized disk. For one or more large disks, such as models 6060, 6061, 6067, and 6122, assume you need 60 for each.

SYSGEN asks the next question only of users with standard NOVA or ECLIPSE configurations. If your processor is housed by a Microproducts chassis, SYSGEN next asks for the number of stacks.

DUAL PROCESSORS (IPB)? ("0" = NO "1" = YES)

Respond with 1 if your system includes two computers connected by an Interprocessor Bus (IPB). Otherwise, type 0.

ENTER NUMBER OF STACKS (1-10)

RDOS can concurrently operate a number of I/O devices equal to the number of stacks you select. An unmapped system requires a minimum of one stack; spooling requires a second stack; and each multiple, concurrent system task requires another. (Spooling saves output intended for a slow peripheral device, such as a line printer, on the disk until the device is ready to accept it.)

Mapped environments require one stack for each foreground and background program; one stack for spooling; and one stack for every system task that will be running concurrently.

RDOS automatically allots two extra system buffers for the fourth stack and each additional stack.

Extended BASIC calls for at least two stacks in an unmapped system and three in a mapped system. System efficiency increases substantially, however, if you have an additional stack (five or more in a mapped system) when supporting multiple BASIC terminals. See Table 3.3 for the number of stacks recommended for your configuration.

System	Stacks	
	Minimum	Recommended
Unmapped	1	2
Mapped	2	3
Extended BASIC, unmapped	2	4 or more
Extended BASIC, mapped	3	5 or more

Table 3.3 Recommended stack allocations

ENTER NUMBER OF EXTRA CELLS (0-64)

A cell is a data buffer of 16 memory words. RDOS runs most efficiently when you add two cells for each simultaneous spooling device except the system console. If, for example, your system included one paper tape reader, one paper tape punch, one line printer, and one magnetic tape controller with or without multiple drives, you would specify eight extra cells. Enter the number of extra cells for your system.

TUNING ("0" = NO "1" = YES)

RDOS provides a self-monitoring feature called *tuning*. It records those instances when a system stack, cell, or buffer was unavailable to RDOS because too few of them were allocated during system generation. This information is stored in disk file SYS.TU (or SYSNAME.TU, where SYSNAME is the descriptive name of your RDOS system). The file can be printed at any time; and, when generating future RDOS systems, SYSGEN can correct the number of stacks, cells, and buffers by analyzing this file and substituting its values for your typed answers. Tuning, when active, consumes one system buffer. It is most useful when tailoring a highly dedicated system. (For more information, see Chapter 4 and the *RDOS System Reference*, DGC No. 093-400027).

Enter 1 to support tuning or 0 to exclude it. SYSGEN asks the next question if you answer 1.

SHALL TUNING BE WITH ("1") OR WITHOUT ("0") OVERLAY REPORT?

The overlay report records the number of times RDOS requires a system overlay, but must read the overlay from the overlay file because it is not core-resident. Although SYSGEN cannot generate a more efficient system from this report, you can use it to determine whether certain overlays are required often enough to warrant the allocation of extra buffer space for them. The overlay reporting feature consumes two extra system buffers when tuning is on.

Type 1 to support the overlay report with tuning, or 0 to exclude it.

ENTER NUMBER OF EXTRA BUFFERS REQUIRED (0-63)

Extra buffers allow disk data and overlay files, ordinarily swapped out to disk, to remain core-resident. The more extra buffers allocated, the less time is required for swapping and the faster and more efficiently RDOS runs. Each extra buffer uses an additional 270 words and reduces the amount of memory available for user programs by that much.

RDOS automatically allots a minimum of six buffers or two per stack, whichever is greater. Block I/O operations reduce the need for extra buffers because RDOS does not require them for this purpose. Conversely, if a reasonable response time is to be maintained, a system that runs multiterminal Extended BASIC needs extra buffers when new users are added.

If you are unsure of your needs, enter 0 for a system with 20 Kwords of memory; 4 for a system with 24 Kwords; or 8 for a system with 32 Kwords or more. Later, if it is supported, you can use the tuning feature to pinpoint your requirements more precisely. Allocating more than 25 extra buffers does not measurably improve system performance.

MAXIMUM NUMBER OF SUBDIRECTORIES/SUBPARTITIONS

ACCESSIBLE AT ONE TIME (0-64)

RDOS allows you to divide each physical disk, or *primary partition*, into sections called *secondary partitions*. Each such section can contain one or more subdirectories. A user or program can address a subdirectory as if it were a self-contained disk drive.

Subdirectories are not required by the RDOS utility programs. Where Extended BASIC is used, a system manager ordinarily assigns a fixed-length secondary partition to each user. If this has been done, enter the maximum number of terminals supported by the Extended BASIC system, plus

one subdirectory for the shared library and one for each disk (itself a directory) that contains any or all of these.

For more information, see *RDOS System Reference* and *RDOS/DOS Command Line Interpreter*.

Magnetic and Cassette Tape Drives

ENTER NUMBER OF CONTROLLERS FOR MTA (0-2)

Enter the number of magnetic tape controllers, not drives, that this system will support. A standard ECLIPSE or NOVA controller of this type can handle up to eight drives; its Microproducts counterpart handles one.

SYSGEN asks the next question only if you specify one magnetic tape controller. It skips the next two questions if you support two Microproducts tape controllers or if yours is a standard NOVA or ECLIPSE configuration and you answer 0. Users with Microproducts peripherals who answer 0 here are next asked about the auto-restart feature.

DEVICE PRIMARY ("0") OR SECONDARY ("1")?

Enter 0 if the controller has a device code of 22 and governs any drive from MT0 through MT7. Enter 1 if the controller has a device code of 62 and handles any drive from MT10 through MT17.

SYSGEN skips the next four questions if this is a Microproducts controller.

ENTER NUMBER OF DEVICES FOR CONTROLLER #1 (1-8)

Supply the number of magnetic tape drives attached to the primary controller. SYSGEN repeats this question for the second controller if you specified one earlier.

ENTER NUMBER OF CONTROLLERS FOR CTA (0-2)

Each cassette controller can supervise up to eight drives. Respond with the number of controllers, not drives, that this system will support.

SYSGEN asks the next question only if you answer 1 to this one. It skips the next two questions if you answer 0.

DEVICE PRIMARY ("0") OR SECONDARY ("1")?

Answer 0 if the controller has a device code of 34 and handles drives CT0 through CT7. Type 1 if this controller has a device code of 74 and governs drives CT10 through CT17.

ENTER NUMBER OF DEVICES FOR CONTROLLER #1 (1-8)

Enter the number of cassette drives attached to the primary controller. SYSGEN repeats this question for the second controller if you specified one earlier.

AUTO RESTART ON POWER FAIL? ("0" = NO "1" = YES)

Answer 1 if your computer has this hardware option and 0 if it does not. Any computer with semiconductor memory must be equipped with battery backup to enable this feature.

OPERATOR MESSAGES? ("0" = NO "1" = YES)

Type 1 if you will be executing programs that use RDOS system or task calls to send and receive messages to and from a system console. Neither the RDOS utilities nor Extended BASIC require this feature.

RTC? ("0" = NO "1" = YES)

Answer according to whether or not your hardware includes a real-time clock.

SYSGEN asks the next two questions only if you answer 1.

DEVICE PRIMARY ("0") OR SECONDARY ("1")?

The primary real-time clock has an I/O device code of 14; the secondary clock has a code of 54. In either case, the clock that you identify here is the only one that will be apparent to your RDOS system, because SYSGEN does not define more than one clock.

ENTER RTC FREQ (1 = 10HZ, 2 = 50HZ, 3 = 60HZ, 4 = 100HZ, 5 = 1000HZ)

Unless you want a special frequency for programs you code yourself, answer 1 for a 10 Hz clock. Extended BASIC, COBOL, and RPG expect and use a frequency of 10 Hz. If you are synchronizing with AC line frequency, type 2 for 50 Hz or 3 for 60 Hz power.

Other Peripherals

ENTER NUMBER OF PTR (0-2)

A single paper tape reader (PTR) has a device code of 12 and the filename \$PTR. A second reader has a code of 52 and the filename \$PTR1. Answer with the number of readers, if any, this system will support.

ENTER NUMBER OF PTP (0-2)

The first paper tape punch (PTP) has a device code of 13 and the filename \$PTP; the second has a code of 53 and the filename \$PTP1. Answer with the number of tape punches, if any, this system will support.

ENTER NUMBER OF LPT (0-2)

The first line printer (LPT) has a device code of 17 and the filename \$LPT; the second has a code of 57 and the filename \$LPT1. Enter the number of line printers this system will support.

SYSGEN skips the next two questions if you answer 0.

ENTER COLUMN SIZE FOR LPT #1 (80 OR 132)

Enter the column size of your first printer.

DATA CHANNEL LINE PRINTER ? ("0" = NO "1" = YES)

If your first (or only) line printer is a data channel device, type 1; otherwise, type 0. (Users whose equipment includes a Microproducts chassis should always answer 0.)

SYSGEN loops back to the previous question and then repeats this one—this time for LPT #2—if you specified a second printer earlier.

ENTER NUMBER OF CDR (0-2)

The first punched or mark-sense card reader (CDR) has a device code of 16 and the filename \$CDR; the second has a code of 56 and the filename \$CDR1. Answer with the number of card readers, if any, this system will support.

ENTER NUMBER OF PLT (0-2)

The first incremental plotter (PLT) has a device code of 15 and the filename \$PLT; the second has a code of 55 and the filename \$PLT1. Respond with the number of plotters, if any, this system will support.

SYSGEN asks the next four questions only if you have a standard NOVA or ECLIPSE configuration. If your equipment includes the Microproducts chassis, proceed to the section, "QTY, ULM, and ALM Multiplexors."

ENTER NUMBER OF MCA (0-2)

Each multiprocessor communications adapter (MCA) includes a transmitter and receiver with distinct device codes and mnemonics. The transmitter of the first MCA has a device code of 06 and the mnemonic MCAT; its receiver has a code of 07 and the mnemonic MCAR. The second transmitter, on device code 46, is called MCAT1, and the second receiver, on code 47, is called MCAR1.

SYSGEN asks the next question only if you answer 1.

DEVICE PRIMARY ("0") OR SECONDARY ("1")?

Type 0 if this is the first MCA or 1 if it is the second. Use the device codes and mnemonics just defined as your guide.

QTY, ULM, and ALM Multiplexors

In most cases, SYSGEN allows you to support one of three types of multiplexor—the asynchronous data multiplexor (QTY), the universal line multiplexor (ULM), or the asynchronous line multiplexor (ALM)—and questions you in depth about the one, if any, that you choose. (SYSGEN omits support for the QTY if your processor is housed by the Microproducts chassis, and first asks, "ULM?") Users of Business BASIC should not specify a multiplexor, because this utility has a multiplexor driver of its own. When Extended BASIC is used, a QTY, ULM, or ALM can be included if desired.

The following two questions apply only to users with standard NOVA or ECLIPSE configurations.

QTY? ("0" = NO "1" = YES)

Enter 1 if you want the new system to support a type 4060 Asynchronous Data Multiplexor. SYSGEN skips to the question "ULM?" if you answer 0.

DEVICE PRIMARY ("0") OR SECONDARY ("1")?

The primary 4060 unit has a device code of 30 and the mnemonic QTY. The secondary unit, with a code of 70, has mnemonic QTY:xx or QTY1:xx, primary and secondary, where xx is a line number from 0 to 63.

SYSGEN skips the following eight questions and next asks, "NUMBER OF LINES?"

ULM? ("0" = NO "1" = YES)

A ULM fits into an I/O slot rather than a separate communications chassis. It can handle up to one synchronous and four asynchronous full-duplex lines. Other Data General-supplied software, such as the Communications Access Manager, must be used in conjunction with synchronous lines if you plan to support them.

SYSGEN skips to the question "ALM?" if you answer 0.

DEVICE PRIMARY ("0") OR SECONDARY ("1")?

The primary ULM has a device code of 34; the secondary unit has a code of 44. Although the mnemonics of these units are ULM and ULM1, respectively, all filenames have the form QTY:xx, where xx is the line number—even if the multiplexor has a device code of 44.

LINE SPEED (BITS/SEC)? ("1" = 19200 "2" = 50

"3" = 75 "4" = 134.5 "5" = 200 "6" = 600

"7" = 2400 "8" = 9600 "9" = 4800 "10" = 1800

"11" = 1200 "12" = 2400 "13" = 300 "14" = 150

"15" = 110)

Your answer selects the data transmission speed for *all* asynchronous lines (but it will not override the line speed set by hardware jumpers, if any). Generally, a higher line speed means faster response to multiplexed terminals, although the main processor must service more interrupts in a given amount of time. When too many interrupts occur at once, the system reports errors due to input buffer overflow, and input characters can be lost. Line speeds of 2400 (7), 4800 (9) or 9600 (8) are recommended. When fast terminal response time is a priority, you might experiment with one of the highest transmission rates and generate another system, with a slower rate, if input characters are lost.

Alternatively, you can define speeds for each line after system generation by editing source file ALMSPD.SR with a text editor and then using the macroassembler to assemble this file. In future dialogues, SYSGEN will use the resulting binary file to implement these characteristics, because the line speed declared in binary ALMSPD overrides the speed you select here.

SYSGEN skips the three questions that follow and next asks about modems.

ALM? ("0" = NO "1" = YES)

Enter 1 to support an ALM, type 4255 through 4258. SYSGEN skips the following eight questions if you answer 0 and next asks, "SECOND TTY?"

DEVICE PRIMARY ("0") OR SECONDARY ("1")

The primary ALM has a device code of 34 and the mnemonic ALM; the secondary unit has a code of 44 and the mnemonic ALM1. The filenames of ALM lines are in the form QTY:xx, where xx is a line number from 0 to 63.

ALM CLOCK FREQUENCY? (0-3)

An ALM has four clocks, each jumpered for a specific line speed. Choose a clock with a frequency that matches the baud rate of your terminals. Often, Data General jumpers the ALM clocks to the customer's specification; but if you are unsure of the correct answer, type 0.

After system generation, you can define a specific clock for each line by editing the source file ALMSPD.SR and assembling it with the macroassembler. In future dialogues, SYSGEN will use the resulting binary file to implement these characteristics, because the clocks declared in binary ALMSPD override the one you specify here.

Modems

The following questions apply only to users who supported a QTY, ULM, or ALM multiplexor earlier.

ARE THERE ANY MODEMS? ("0" = NO "1" = YES)

Type 1 only if you plan to use modems. A 0 answer results in a system that excludes modem support and ignores modem interrupts, although modems can still be connected to it and their states controlled by writing to file QTY:64.

SYSGEN asks the next question only if you answer 1. Otherwise, it skips to the questions under the subsection entitled "Line Characteristics."

STANDARD MODEM TIMER? ("0" = NO "1" = YES)

A response of 1 enables the RDOS system to support the standard timer and is highly recommended. This timer, which supports all known modems, answers on a "ring"; waits up to 90 seconds for a carrier indication; permits data dropouts for up to five seconds; and disconnects on either a time-out or a program request made through a write to file QTY:64. State logic, included in this modem timer package, filters out any anomalies in the modem signal.

The standard timer consists of an overlay-resident system task. It runs once every five seconds only when a modem is connected and does not indicate the presence of a carrier. The task does not run at all when modems are inactive or passing nothing more than a carrier signal. Alternatively, users can select the Data Set Ready signal as an activity indicator, on a line-by-line basis, by editing and assembling source file ALMSPD.SR after system generation. This alternative can be useful in half-duplex line operations, when no carrier is used, or to defeat the time-out feature. The standard timer package increases the resident portion of RDOS by one word per line.

An answer of 0 selects a smaller modem timer, resulting in less system overhead. It differs from the standard package mainly in its use of the Data Set Ready signal as an indicator of connection states. This timer has been proven reliable in the U.S. when used with modems of the type supplied by telephone companies. It cannot handle nuisance calls, however, nor can it handle modems that do not drop the Data Set Ready signal upon line loss.

Line Characteristics

SYSGEN asks this series of questions only if you specified a QTY, ULM, or ALM earlier. If you did not, skip to the question under "Secondary Console."

NUMBER OF LINES? (1-64)

Enter the number of lines for this system. The multiplexor driver is designed to ignore I/O activity on lines beyond the number entered here. Lines not supported by the system are turned off when they generate an interrupt, suppressing subsequent interrupts when an ALM or ULM is used. No attempt is made to initialize lines that have not been included during system generation.

USE DEFAULT ALMIQTY INTERRUPT CHARACTERS ("0"=NO "1"=YES)

The default interrupt characters for multiplexed lines are CTRL-A and CTRL-C. Type 1 to support them or 0 to define two different interrupt characters for your lines. (SYSGEN asks the next two questions only if you answer 0 here.) Remember that Multi-user Extended BASIC systems require that one of these characters be ESC (decimal ASCII 27).

FIRST CHARACTER (ASCII DECIMAL CODE OR "128"=NONE)

Using Appendix C as your guide, enter the decimal code of the interrupt character that will replace CTRL-A or type 128 to support only one or no interrupt characters.

SECOND CHARACTER (ASCII DECIMAL CODE OR "128"=NONE)

Using Appendix C as your guide, enter the decimal code of the interrupt character that will replace CTRL-C or type 128 to omit a second interrupt character.

Secondary Console

SECOND TTY? ("0"=NO "1"=YES)

Type 1 if you have a console connected to the second teletypewriter interface. Such a console is independent of multiplexors. (A system can have one primary console or a primary and secondary console with or without a multiplexor.) The second console has device codes and filenames 50 and \$TTI1 and 51 and \$TTO1 for input and output, respectively.

Core Dumps

The core dump program copies the memory state of the computer to a device when the system comes down unexpectedly. You can also invoke the program yourself, as explained in the *RDOS System Reference* (DGC No. 093-400027).

SYSGEN allows you to direct core dumps to one of the following devices:

- the primary line printer (\$LPT)
- any NOVA/ECLIPSE tape drive on the primary controller (MT0-MT7)
- a Microproducts tape drive on the primary controller (MT0)
- the last single-density diskette on the primary or secondary NOVA/ECLIPSE controller (DP3 or DP7)
- any double-density diskette (Microproducts or NOVA/ECLIPSE) on the primary controller (DP0-DP7 or DE0-DE7)

Choose only one of these devices to receive core dumps. The device you select need not be one of the peripherals that you specified earlier.

CORE DUMP FACILITY? ("0"=NO "1"=LPT "2"=MTA "3"=6030 "4"=6097)

or

CORE DUMP FACILITY? ("0"=NO "1"=LPT "2"=MTA "3"=6096)

SYSGEN asks the first question of users with standard NOVA or ECLIPSE configurations. The second version applies to users with Microproducts peripherals.

An answer of 2, 3, or 4 (where applicable) is recommended, because Data General requires a core dump on magnetic tape or diskette to troubleshoot system problems. The core dump feature requires between 200 and 330 memory locations.

SYSGEN asks the next four questions selectively, based on your answer here. Its next question pertains to user-defined devices if you answered 0.

DATA CHANNEL LINE PRINTER? ("0"=NO "1"=YES)

This question applies only to users who supported core dumps to LPT, but who did not include a line printer earlier.

Because core dumps can only be sent to the primary line printer (\$LPT), your answer depends on whether this printer is a data channel type. SYSGEN skips the following three questions and next asks about user-defined devices.

ENTER MTA UNIT NUMBER TO RECEIVE CORE DUMP (0-7)

This question applies only to users who supported core dumps to a magnetic tape unit. A copy of the memory state of your computer fits on one reel of magnetic tape, even if you specified the maximum size of memory earlier.

Only tape units on the primary controller can receive a core dump. If this is a Microproducts controller, enter 0.

SYSGEN skips the following two questions and next asks about user-defined devices.

DEVICE PRIMARY ("0") OR SECONDARY ("1")?

This question applies only to users who supported core dumps to a single- or double-density diskette (models 6030, 6096, or 6097.)

Type 0 if the diskette drive is attached to the first controller or 1 if it is attached to the second. (Remember that only

double-density drives on the primary controller can receive core dumps.)

SYSGEN asks the next question only if you chose core dumps to a double-density diskette. Otherwise, the next question pertains to user-defined devices.

ENTER 6097 UNIT NUMBER TO RECEIVE CORE DUMP (0-3)

or

ENTER 6096 UNIT NUMBER TO RECEIVE CORE DUMP (0-3)

The line of peripherals your computer supports determines which of these questions SYSGEN asks. Model 6097 is a standard NOVA/ECLIPSE drive; model 6096 belongs to the Microproducts line. Choose one diskette drive to receive core dumps and type its unit number here.

User-Defined Devices

The following questions allow you to specify as many as 64 user-defined devices during system generation. These are devices not supported by the operating system, but defined by the user via the .IDEF system call. For details on .IDEF, see the *RDOS System Reference* (DGC No. 093-400027).

ANY USER DEFINED DEVICES? ("0" = NO "1" = YES)

Type 1 to support user-defined devices or 0 to exclude them. If you are not entirely sure that RDOS supports all the devices defined by your programs, type 1.

This is the last of SYSGEN's questions if you answer 0.

ENTER NUMBER OF USER DEFINED DEVICES (1-64)

Supply the maximum number of devices you plan to define. If you are not certain of the number, specify 10. Note that, for most versions of RDOS, six words are reserved for each potential user-defined device table. The exception is MRDOS, which requires, and therefore reserves, two words per device.

This is the last question in the system generation series. Using your answers, SYSGEN proceeds to build a tailored system, as described in the next subsection.

Closing Procedures

With the dialogue concluded, SYSGEN selects the modules for your new system, identifies them in a system-creating command line, and stores this command line in a file named CLI.CM. SYSGEN then instructs RDOS to execute CLI.CM, which instructs the Relocatable Loader to build your tailored system.

To display the system-creating command at your console, wait for the CLI prompt and then issue the following statement:

TYPE CLI.CM. <CR>

SYSGEN takes several minutes to build the new system and then returns control to the CLI.

Testing a New System

This section explains how to test a new RDOS system. It also explains what to do if the new system does not run.

After your session with SYSGEN, the CLI prompt (R) should appear at your console. The prompt indicates that your tailored system has been built and that control has returned to the RDOS starter system.

Bring up the tailored system by typing

BOOT SYS <CR>

If you identified your system with a unique name, enter it in place of SYS, for example:

BOOT SMALLSYS <CR>

MASTER DEVICE RELEASED

RDOS REV 7.10

DATE (M/D/Y)?

Enter the system date, for example:

7 26 83 <CR>

TIME (H:M:S)?

Set the time for your new system, for example:

11 45 <CR>

The CLI prompt then appears, signaling that your tailored RDOS system is up and running from the master disk. (If the new system fails to come up, review steps 1 through 4 at the end of this section.)

If you have a line printer, make a copy of your SYSGEN dialogue and load map files with the CLI print command, for example:

PRINT SYS.(SG LM) <CR>

Substitute a descriptive name for SYS if you used one to invoke SYSGEN earlier, for example:

PRINT SMALLSYS.(SG LM) <CR>

If you do not have a line printer, use the TYPE command to obtain listings at a hard-copy terminal, for example:

```
TYPE SYS.(SG LM) (CR)
```

Save these records of the script and load map files for use when patching or tuning your system, as discussed in Chapter 4.

Having generated and bootstrapped a tailored RDOS system, you can invoke SYSGEN at any time, without the starter system's assistance, by issuing the following command line:

```
SYSGEN SYS.(SV/S SG/V LM/L) (CR)
```

You can generate a new system to manage a different application or tune an existing system, as described in Chapter 4. Or you may want to experiment with this RDOS system for a while.

When you are finished, always close down the operating system before your hardware. Use the CLI command RELEASE, followed by the unit name of the hard disk on which your RDOS system resides, for example:

```
RELEASE DP0 (CR)
```

Then proceed to Chapter 4, which discusses system maintenance and expansion.

If your new system fails to run—that is, if you receive an error message or the CLI prompt does not appear—take the following steps.

1. Program load your computer and bootstrap the RDOS starter system using the instructions in Chapter 4, "Starting Up the System," as your guide. Specify FBOOTSYS when BOOT.SV asks for a filename. Then set the date and time.
2. When the CLI prompt appears, delete the system script and load map files by typing DELETE SYS.(SG,LM). If you gave a unique name to your system, substitute that name for SYS in the command line, for example, DELETE/V SMALLSYS.(SG,LM).
3. Return to the section entitled "Running the System Generation Program" and invoke SYSGEN once more, using the same default (SYS) or descriptive name that you supplied earlier. (When two systems are identified with the same name, the existing—and, in this case, defective—system is deleted and replaced by the new one.) As you execute the dialogue, correct your answer or answers based on the error message, if any, that you received. (See Appendix B for an explanation of error message handling.)

4. Test the new system according to the instruction in this section. Then proceed to Chapter 4, which explains how to maintain and expand your tailored RDOS system.

Summary

This section is intended as a guide for first-time users of SYSGEN and as a reference for more experienced users. It contains five sample dialogues with the system generator. Each dialogue represents a unique configuration that the resulting system will support.

Figure 3.1 shows how to generate a system for a mapped ECLIPSE S/20 computer that supports several Microproducts peripherals, including one fixed-disk drive and one double-density diskette drive, a magnetic tape unit, and the ULM.

Figure 3.2 illustrates the generation of a system for a mapped ECLIPSE S/280 computer that supports two fixed and two cartridge disk drives, a magnetic tape unit, and an ALM.

Figure 3.3 shows how to generate a system for a mapped NOVA 4 computer that supports one fixed-disk drive, one tape drive, and three double-density diskette drives.

Figure 3.4 depicts the generation of a system for an unmapped ECLIPSE C/150 computer that supports two cartridge disk drives, three single-density diskette drives, and two tape drives.

Figure 3.5 illustrates the generation of a system for an unmapped NOVA 4 computer that supports one fixed disk drive and one double-density diskette drive.

Each dialogue assumes that your RDOS starter system—or a system generated previously—is already up and running from drive 0 and that you have just invoked the system generation program.

RDOS SYSTEM GENERATOR REV 7.10

VALID ANSWERS ARE PRESENTED IN PARENTHESES FOLLOWING EACH QUESTION. CHOOSE THE APPROPRIATE ONE.

ENTER PROCESSOR MODEL. (CURRENTLY SUPPORTED MODELS

INCLUDE: NOVA NOVA/2 NOVA/3 NOVA/4 NOVA/800
NOVA/820 NOVA/830 NOVA/840 NOVA/1200 S/20
S/120 S/130 AP/130 S/140 C/150 S/200
S/230 S/250 S/250IAP S/280 C/300 C/330 AND C/350) : S/20

MAPPED SYSTEM? ("0"=NO "1"=YES) 1

ENTER MEMORY SIZE IN NUMBER OF 1 KW PAGES (40-256): 64
SYSTEM OVERLAYS RESIDENT ? ("0"=NO "1"=YES) 0
SIZE OF SHARED DATA AREA IN PAGES (0-32) 0
MAXIMUM NUMBER OF CHANNELS BACKGROUND WILL USE (1-255) 20
MAXIMUM NUMBER OF CHANNELS FOREGROUND WILL USE (0-255) 20

NUMBER OF 6096/6102/6105/6220/6222 DISK CONTROLLERS? (0-2) 1

DEVICE PRIMARY ("0") OR SECONDARY ("1")? 0
CONTROLLER # 1 6220/6222 TYPE DISKS? ("0"=NO "1"=YES) 0
NUMBER OF DEVICES FOR CONTROLLER # 1? (1-4) 2

NUMBER OF 6095 DISK CONTROLLERS? (0-2) 0

ENTER BAD BLOCK POOL SIZE IN BLOCKS (0-512) 10

ENTER NUMBER OF STACKS (1-10) 4

ENTER NUMBER OF EXTRA CELLS (0-64) 10

TUNING? ("0"=NO "1"=YES) 1

SHALL TUNING BE WITH("1") OR WITHOUT("0") OVERLAY REPORT? 1

ENTER NUMBER OF EXTRA BUFFERS REQUIRED (0-63) 10

MAXIMUM NUMBER OF SUBDIRECTORIES/SUBPARTITIONS

ACCESSIBLE AT ONE TIME (0-64) 15

ENTER NUMBER OF CONTROLLERS FOR MTA (0-2) 1

DEVICE PRIMARY("0") OR SECONDARY("1")? 0

AUTO RESTART ON POWER FAIL? ("0"=NO "1"=YES) 0

OPERATOR MESSAGES? ("0"=NO "1"=YES) 1

RTC? ("0"=NO "1"=YES) 1

DEVICE PRIMARY("0") OR SECONDARY("1")? 0

ENTER RTC FREQ (1=10HZ 2=50HZ 3=60HZ 4=100HZ 5=1000HZ) 1

ENTER NUMBER OF PTR(0-2) 0

ENTER NUMBER OF PTP(0-2) 0

ENTER NUMBER OF LPT(0-2) 1

ENTER COLUMN SIZE FOR LPT #1 (80 OR 132) 80

DATA CHANNEL LINE PRINTER? ("0"=NO "1"=YES) 0

ENTER NUMBER OF CDR(0-2) 0

ENTER NUMBER OF PLT(0-2) 0

ULM? ("0"=NO "1"=YES) 1

DEVICE PRIMARY("0") OR SECONDARY("1")? 0

LINE SPEED (BITS/SEC)?("1"=19200 "2"=50 "3"=75

"4"=134.5 "5"=200 "6"=600 "7"=2400 "8"=9600

"9"=4800 "10"=1800 "11"=1200 "12"=2400 "13"=300

"14"=150 "15"=110) 9

ARE THERE ANY MODEMS ? ("0"=NO "1"=YES) 0

NUMBER OF LINES ? (1-64) 8

USE DEFAULT ALM/QTY INTERRUPT CHARACTERS? ("0"=NO "1"=YES) 1

SECOND TTY? ("0"=NO "1"=YES) 1

CORE DUMP? ("0"=NO "1"=LPT "2"=MTA "3"=6096) 2

ENTER MTA UNIT NUMBER TO RECEIVE CORE DUMP (0-7) 0

ANY USER DEFINED DEVICES ? ("0"=NO "1"=YES) 1

ENTER NUMBER OF USER DEFINED DEVICES (1-64) 10

Figure 3.1 Sample generation of mapped S/20 system supporting Microproducts peripherals

DG-09535

RDOS SYSTEM GENERATOR REV 7.10

VALID ANSWERS ARE PRESENTED IN PARENTHESES FOLLOWING EACH QUESTION. CHOOSE THE APPROPRIATE ONE.

ENTER PROCESSOR MODEL. (CURRENTLY SUPPORTED MODELS

INCLUDE: NOVA NOVA/2 NOVA/3 NOVA/4 NOVA/800
NOVA/820 NOVA/830 NOVA/840 NOVA/1200 S/20
S/120 S/130 AP/130 S/140 C/150 S/200
S/230 S/250 S/250IAP S/280 C/300 C/330 AND C/350) : S/280

BURST MULTIPLEXOR CHANNEL (BMC) ? ("0"=NO "1"=YES) 1

MAPPED SYSTEM? ("0"=NO "1"=YES) 1

ENTER MEMORY SIZE IN NUMBER OF 1 KW PAGES (64-1024): 256
SYSTEM OVERLAYS RESIDENT ? ("0"=NO "1"=YES) 1
SIZE OF SHARED DATA AREA IN PAGES (0-32) 10
MAXIMUM NUMBER OF CHANNELS BACKGROUND WILL USE (1-255) 40
MAXIMUM NUMBER OF CHANNELS FOREGROUND WILL USE (0-255) 40

NUMBER OF NOVADISK DISK CONTROLLERS (0-2) 0
NUMBER OF 6063/6064 DISK CONTROLLERS (0-2) 0
NUMBER OF 6060/6061/6067/6122/6160/6161 DISK CONTROLLERS (0-2) 1
DEVICE PRIMARY ("0") OR SECONDARY ("1")? 0
CONTROLLER #1 ON BMC? ("0"=NO "1"=YES) 1
CONTROLLER #1 6160/6161 TYPE? ("0"=NO "1"=YES) 1
NUMBER OF DEVICES FOR CONTROLLER #1 (1-2) 2
NUMBER OF OTHER TYPES OF MOVING HEAD DISK CONTROLLERS (0-2) 1
DEVICE PRIMARY ("0") OR SECONDARY ("1")? 0
NUMBER OF DEVICES FOR CONTROLLER #1 (1-4) 2
TOP LOADER(S)? ("0"=NO "1"=YES) 1
ENTER BAD BLOCK POOL SIZE IN BLOCKS (0-512) 40
DUAL PROCESSORS (IPB)? ("0"=NO "1"=YES) 0
ENTER NUMBER OF STACKS (1-10) 6
ENTER NUMBER OF EXTRA CELLS (0-64) 20
TUNING? ("0"=NO "1"=YES) 1
SHALL TUNING BE WITH ("1") OR WITHOUT ("0") OVERLAY REPORT? 0

ENTER NUMBER OF EXTRA BUFFERS REQUIRED (0-63) 15
MAXIMUM NUMBER OF SUBDIRECTORIES/SUBPARTITIONS ACCESSIBLE AT ONE TIME (0-64) 20
ENTER NUMBER OF CONTROLLERS FOR MTA (0-2) 1
DEVICE PRIMARY ("0") OR SECONDARY ("1")? 0
ENTER NUMBER OF DEVICES FOR CONTROLLER #1 (1-8) 2
ENTER NUMBER OF CONTROLLERS FOR CTA (0-2) 0
AUTO RESTART ON POWER FAIL? ("0"=NO "1"=YES) 1
OPERATOR MESSAGES? ("0"=NO "1"=YES) 1
RTC? ("0"=NO "1"=YES) 1
DEVICE PRIMARY ("0") OR SECONDARY ("1")? 0
ENTER RTC FREQ (1=10HZ 2=50HZ 3=60HZ 4=100HZ 5=1000HZ) 1
ENTER NUMBER OF PTR (0-2) 0
ENTER NUMBER OF PTP (0-2) 0
ENTER NUMBER OF LPT (0-2) 1
ENTER COLUMN SIZE FOR LPT #1 (80 OR 132) 80
DATA CHANNEL LINE PRINTER? ("0"=NO "1"=YES) 1
ENTER NUMBER OF CDR (0-2) 0
ENTER NUMBER OF PLT (0-2) 0
ENTER NUMBER OF MCA (0-2) 0
QTY? ("0"=NO "1"=YES) 0
ULM? ("0"=NO "1"=YES) 0
ALM? ("0"=NO "1"=YES) 1
DEVICE PRIMARY ("0") OR SECONDARY ("1")? 0
ALM CLOCK FREQUENCY? (0-3) 1
ARE THERE ANY MODEMS? ("0"=NO "1"=YES) 1
STANDARD MODEM TIMER? ("0"=NO "1"=YES) 1
NUMBER OF LINES? (1-64) 10
USE DEFAULT ALM/QTY INTERRUPT CHARACTERS? ("0"=NO "1"=YES) 1
SECOND TTY? ("0"=NO "1"=YES) 1
CORE DUMP? ("0"=NO "1"=LPT "2"=MTA "3"=6030 "4"=6097) 2
ENTER MTA UNIT NUMBER TO RECEIVE CORE DUMP (0-7) 0
ANY USER DEFINED DEVICES ? ("0"=NO "1"=YES) 1
ENTER NUMBER OF USER DEFINED DEVICES (1-64) 10

Figure 3.2 Sample generation of mapped S/280 system

DG-09536

RDOS SYSTEM GENERATOR REV 7.10

VALID ANSWERS ARE PRESENTED IN PARENTHESES FOLLOWING EACH QUESTION. CHOOSE THE APPROPRIATE ONE.

ENTER PROCESSOR MODEL. (CURRENTLY SUPPORTED MODELS INCLUDE: NOVA NOVA/2 NOVA/3 NOVA/4 NOVA/800 NOVA/820 NOVA/830 NOVA/840 NOVA/1200 S/20 S/120 S/130 AP/130 S/140 C/150 S/200 S/230 S/250 S/250IAP S/280 C/300 C/330 AND C/350) : NOVA/4

MAPPED SYSTEM? ("0"=NO "1"=YES) 1
 ENTER MEMORY SIZE IN NUMBER OF 1 KW PAGES (40-128): 128
 SYSTEM OVERLAYS RESIDENT ? ("0"=NO "1"=YES) 1
 SIZE OF SHARED DATA AREA IN PAGES (0-16) 0
 MAXIMUM NUMBER OF CHANNELS BACKGROUND WILL USE (1-255) 60
 MAXIMUM NUMBER OF CHANNELS FOREGROUND WILL USE (0-255) 60

NUMBER OF NOVADISK DISK CONTROLLERS (0-2) 0
 NUMBER OF 6063/6064 DISK CONTROLLERS (0-2) 0
 NUMBER OF 6060/6061/6067/6122/6160/6161 DISK CONTROLLERS (0-2) 1
 DEVICE PRIMARY ("0") OR SECONDARY ("1")? 0
 CONTROLLER #1 6160/6161 TYPE? ("0"=NO "1"=YES) 1
 NUMBER OF DEVICES FOR CONTROLLER #1 (1-2) 1
 NUMBER OF OTHER TYPES OF MOVING HEAD DISK CONTROLLERS (0-2) 1
 DEVICE PRIMARY("0") OR SECONDARY ("1")? 0
 NUMBER OF DEVICES FOR CONTROLLER #1 (1-4) 3
 TOP LOADER(S)? ("0"=NO "1"=YES) 0
 ENTER BAD BLOCK POOL SIZE IN BLOCKS (0-512) 30
 DUAL PROCESSORS (IPB)? ("0"=NO "1"=YES) 0
 ENTER NUMBER OF STACKS (1-10) 4
 ENTER NUMBER OF EXTRA CELLS (0-64) 15
 TUNING? ("0"=NO "1"=YES) 0
 ENTER NUMBER OF EXTRA BUFFERS REQUIRED (0-63) 12
 MAXIMUM NUMBER OF SUBDIRECTORIES/SUBPARTITIONS ACCESSIBLE AT ONE TIME (0-64) 20
 ENTER NUMBER OF CONTROLLERS FOR MTA (0-2) 1
 DEVICE PRIMARY("0") OR SECONDARY ("1")? 0
 ENTER NUMBER OF DEVICES FOR CONTROLLER #1 (1-8) 1
 ENTER NUMBER OF CONTROLLERS FOR CTA (0-2) 0
 AUTO RESTART ON POWER FAIL? ("0"=NO "1"=YES) 0
 OPERATOR MESSAGES? ("0"=NO "1"=YES) 1
 RTC? ("0"=NO "1"=YES) 1
 DEVICE PRIMARY("0") OR SECONDARY("1")? 0
 ENTER RTC FREQ (1=10HZ 2=50HZ 3=60HZ 4=100HZ 5=1000HZ) 1
 ENTER NUMBER OF PTR (0-2) 0
 ENTER NUMBER OF PTP (0-2) 0
 ENTER NUMBER OF LPT (0-2) 1
 ENTER COLUMN SIZE FOR LPT #1 (80 OR 132) 80
 DATA CHANNEL LINE PRINTER? ("0"=NO "1"=YES) 0
 ENTER NUMBER OF CDR (0-2) 0
 ENTER NUMBER OF PLT (0-2) 0
 ENTER NUMBER OF MCA (0-2) 0
 QTY? ("0"=NO "1"=YES) 0
 ULM? ("0"=NO "1"=YES) 0
 ALM? ("0"=NO "1"=YES) 0
 SECOND TTY? ("0"=NO "1"=YES) 1
 CORE DUMP? ("0"=NO "1"=LPT "2"=MTA "3"=6030 "4"=6097) 4
 DEVICE PRIMARY ("0") OR SECONDARY ("1")? 0
 ENTER 6097 UNIT NUMBER TO RECEIVE CORE DUMP (0-3) 1
 ANY USER DEFINED DEVICES ? ("0"=NO "1"=YES) 0

Figure 3.3 Sample generation of mapped NOVA 4 system

DG-09537

RDOS SYSTEM GENERATOR REV 7.10

VALID ANSWERS ARE PRESENTED IN PARENTHESES FOLLOWING EACH QUESTION. CHOOSE THE APPROPRIATE ONE.

ENTER PROCESSOR MODEL. (CURRENTLY SUPPORTED MODELS INCLUDE: NOVA NOVA/2 NOVA/3 NOVA/4 NOVA/800 NOVA/820 NOVA/830 NOVA/840 NOVA/1200 S/20 S/120 S/130 AP/130 S/140 C/150 S/200 S/230 S/250 S/250IAP S/280 C/300 C/330 AND C/350) : C/150

MAPPED SYSTEM? ("0"=NO "1"=YES) 0
 NUMBER OF PATCH SPACE BLOCKS (0-64)? 8
 MEMORY SIZE IN 1 KW INCREMENTS (16-32): 32
 NUMBER OF NOVADISK DISK CONTROLLERS (0-2) 0
 NUMBER OF 6063/6064 DISK CONTROLLERS (0-2) 0
 NUMBER OF 6060/6061/6067/6122/6160/6161 DISK CONTROLLERS (0-2) 0
 NUMBER OF OTHER TYPES OF MOVING HEAD DISK CONTROLLERS (0-2) 2
 NUMBER OF DEVICES FOR CONTROLLER #1 (1-4) 2
 TOP LOADER(S)? ("0"=NO "1"=YES) 1
 NUMBER OF DEVICES ON CONTROLLER #2 (1-4) 3
 TOP LOADER(S)? ("0"=NO "1"=YES) 0
 ENTER BAD BLOCK POOL SIZE IN BLOCKS (0-512) 20
 DUAL PROCESSORS (IPB)? ("0"=NO "1"=YES) 0
 ENTER NUMBER OF STACKS (1-10) 2
 ENTER NUMBER OF EXTRA CELLS (0-64) 5
 TUNING? ("0"=NO "1"=YES) 0
 ENTER NUMBER OF EXTRA BUFFERS REQUIRED (0-63) 4
 MAXIMUM NUMBER OF SUBDIRECTORIES/SUBPARTITIONS ACCESSIBLE AT ONE TIME (0-64) 12
 ENTER NUMBER OF CONTROLLERS FOR MTA (0-2) 1
 DEVICE PRIMARY ("0") OR SECONDARY ("1")? 0
 ENTER NUMBER OF DEVICES FOR CONTROLLER #1 (1-8) 2
 ENTER NUMBER OF CONTROLLERS FOR CTA (0-2) 0
 AUTO RESTART ON POWER FAIL? ("0"=NO "1"=YES) 0
 OPERATOR MESSAGES? ("0"=NO "1"=YES) 0
 RTC? ("0"=NO "1"=YES) 1
 DEVICE PRIMARY ("0") OR SECONDARY ("1")? 0
 ENTER RTC FREQ (1=10HZ 2=50HZ 3=60HZ 4=100HZ 5=1000HZ) 1
 ENTER NUMBER OF PTR (0-2) 0
 ENTER NUMBER OF PTP (0-2) 0
 ENTER NUMBER OF LPT (0-2) 1
 ENTER COLUMN SIZE FOR LPT #1 (80 OR 132) 80
 DATA CHANNEL LINE PRINTER? ("0"=NO "1"=YES) 0
 ENTER NUMBER OF CDR (0-2) 0
 ENTER NUMBER OF PLT (0-2) 0
 ENTER NUMBER OF MCA (0-2) 0
 QTY? ("0"=NO "1"=YES) 0
 ULM? ("0"=NO "1"=YES) 0
 ALM? ("0"=NO "1"=YES) 0
 SECOND TTY? ("0"=NO "1"=YES) 0
 CORE DUMP? ("0"=NO "1"=LPT "2"=MTA "3"=6030 "4"=6097) 3
 DEVICE PRIMARY ("0") OR SECONDARY ("1")? 0
 ANY USER DEFINED DEVICES ? ("0"=NO "1"=YES) 0

Figure 3.4 Sample generation of unmapped C/150 system

DG-09538

RDOS SYSTEM GENERATOR REV 7.10

VALID ANSWERS ARE PRESENTED IN PARENTHESES FOLLOWING
EACH QUESTION. CHOOSE THE APPROPRIATE ONE.

ENTER PROCESSOR MODEL. (CURRENTLY SUPPORTED MODELS

INCLUDE: NOVA NOVA/2 NOVA/3 NOVA/4 NOVA/800
NOVA/820 NOVA/830 NOVA/840 NOVA/1200 S/20
S/120 S/130 AP/130 S/140 C/150 S/200
S/230 S/250 S/250IAP S/280 C/300 C/330 AND C/350) : NOVA/4

NUMBER OF PATCH SPACE BLOCKS (0-64)? 8
MEMORY SIZE IN 1 KW INCREMENTS (16-32): 32

NUMBER OF NOVADISK DISK CONTROLLERS (0-2) 0
NUMBER OF 6063/6064 DISK CONTROLLERS (0-2) 0
NUMBER OF 6060/6061/6067/6122/6160/6161 DISK CONTROLLERS (0-2) 0
NUMBER OF OTHER TYPES OF MOVING HEAD DISK CONTROLLERS (0-2) 1
DEVICE PRIMARY("0") OR SECONDARY ("1")? 0
NUMBER OF DEVICES FOR CONTROLLER #1 (1-4) 2
TOP LOADER(S)? ("0"=NO "1"=YES) 0
ENTER BAD BLOCK POOL SIZE IN BLOCKS (0-512) 10
DUAL PROCESSORS (IPB)? ("0"=NO "1"=YES) 0
ENTER NUMBER OF STACKS (1-10) 2
ENTER NUMBER OF EXTRA CELLS (0-64) 5
TUNING? ("0"=NO "1"=YES) 0
ENTER NUMBER OF EXTRA BUFFERS REQUIRED (0-63) 6
MAXIMUM NUMBER OF SUBDIRECTORIES/SUBPARTITIONS
ACCESSIBLE AT ONE TIME (0-64) 15
ENTER NUMBER OF CONTROLLERS FOR MTA (0-2) 0
ENTER NUMBER OF CONTROLLERS FOR CTA (0-2) 0
AUTO RESTART ON POWER FAIL? ("0"=NO "1"=YES) 0
OPERATOR MESSAGES? ("0"=NO "1"=YES) 0
RTC? ("0"=NO "1"=YES) 1
DEVICE PRIMARY ("0") OR SECONDARY ("1")? 0
ENTER RTC FREQ (1=10HZ 2=50HZ 3=60HZ 4=100HZ 5=1000HZ) 1
ENTER NUMBER OF PTR (0-2) 0
ENTER NUMBER OF PTP (0-2) 0
ENTER NUMBER OF LPT (0-2) 1
ENTER COLUMN SIZE FOR LPT #1 (80 OR 132) 80
DATA CHANNEL LINE PRINTER? ("0"=NO "1"=YES) 0
ENTER NUMBER OF CDR (0-2) 0
ENTER NUMBER OF PLT (0-2) 0
ENTER NUMBER OF MCA (0-2) 0
QTY? ("0"=NO "1"=YES) 0
ULM? ("0"=NO "1"=YES) 0
ALM? ("0"=NO "1"=YES) 0
SECOND TTY? ("0"=NO "1"=YES) 0
CORE DUMP? ("0"=NO "1"=LPT "2"=MTA "3"=6030 "4"=6097) 1
ANY USER DEFINED DEVICES ? ("0"=NO "1"=YES) 0

Figure 3.5 Sample generation of unmapped NOVA 4 system

DG-09539

Maintaining Your System

This chapter explains how to maintain and expand your RDOS system. It discusses starting up and closing down RDOS; introduces new disks; and presents several techniques for backing up files. The chapter concludes with discussions of system tuning and patching.

A reading of the entire chapter is recommended if this is your first RDOS system. Chapter 5, which discusses DKINIT, the disk initializer, is also recommended. System maintenance and expansion are discussed further in *Introduction to RDOS*. The *RDOS/DOS Command Line Interpreter* describes all CLI commands referred to here.

Starting Up the System

This section explains how to start up a system when none is running and how to bootstrap other systems and programs from the CLI.

As explained in Chapter 1, the process of bootstrapping brings software into main memory from a peripheral device. The bootstrap root ushers a longer bootstrap routine into memory, and the bootstrap routine in turn brings all other software into memory from a device.

All disks or diskettes that hold RDOS systems or stand-alone programs must contain a bootstrap root and the RDOS bootstrap routine, BOOT.SV. (A stand-alone program is a program the execution of which does not require an operating system.) Disks or diskettes comprised solely of data files are the only exceptions to this rule. To bootstrap a first system or program requires a drive with a unit name that ends in 0 or 4. This is because the loader program expects to find your bootstrap medium in the first drive on its controller. Chapter 1 explains how drive numbers can be manipulated with the thumbwheel unit-select knobs on some units or the metal toggle switch found on or behind the front panels of other units.

Follow these steps to bootstrap from a disk or diskette without the assistance of a CLI:

1. Power up all equipment if it is not already on. Put the system console and line printer, if any, on line. Stop the computer by pressing the BREAK key on your keyboard or the STOP switch on the front panel of your computer.
2. Where applicable, insert your master disk pack or cartridge disk in drive 0; press the rocker switch to RUN, READY, or START; and wait for the READY light. (Be sure to power up the adapter, if any, associated with this drive.) If your master disk is a fixed model, make sure that its unit-select switch, if any, is set to 0.
3. Program load your computer. If you have a virtual console, refer to Table 4.1 for the appropriate code and type it at your system console.

With the automatic program load (APL) option only, place the rocker switch on the front panel of the computer to the PR LOAD position.

With hardware data switches and APL, set the data switches using Table 4.1 as your guide. Then lift RESET, followed by PROGRAM LOAD; or, on a SUPERNOVA computer, press CHANNEL START.

If you have hardware data switches, but no APL, set the switches as follows:

- Lift switches 8 through 14 up and press the others down. Then lift EXAMINE, check the lighted address lamps, and release it.
- Set switches according to Table 4.1. Then lift DEPOSIT, verify the settings, and release it.
- Lift switches 8 through 15 up and press the others down. Depress DEPOSIT NEXT, verify the settings, and release it.
- Again, lift switches 8 through 14 up and press the others down. Lift and release first the RESET and then the START switches.

Disk Type	Virtual Console Entry	Switch Settings (with APL)	Switch Settings (no APL)
NOVADISKS (6001-6008)			
First controller	100020L	0, 11 and up	1, 2, 9, 11 and up
Second controller	100060L	0, 10, 11 and up	1, 2, 9, 10, and 11, and up
NOVA/ECLIPSE models 6060, 6061, 6067, 6122, 6160, or 6161			
First controller	100027L	0, 11, 13, 14, 15 and up	1, 2, 9, 11, 13, 14, 15 and up
Second controller	100067L	0, 10, 11, 13, 14, 15 and up	1, 2, 9, 10, 11, 13, 14, 15 and up
NOVA/ECLIPSE models 6063 or 6064			
First controller	100026L	0, 11, 13, 14, and up	1, 2, 9, 11, 13, 14, and up
Second controller	100066L	0, 10, 11, 13, 14, and up	1, 2, 9, 10, 11, 13, 14, and up
Microproducts fixed discs			
First controller	26H	—	—
Second controller	66H	—	—
Microproducts cartridge disks			
First controller	27H	—	—
Second controller	67H	—	—
All other disks			
First controller	100033L	0, 11, 12, 14, 15, and up	1, 2, 9, 10, 11, 12, 14, 15, and up
Second controller	100073L	0, 10, 11, 12, 14, 15, and up	1, 2, 9, 10, 11, 12, 14, 15, and up

Table 4.1 Program loading after system generation

¹For virtual consoles on ECLIPSE S/120 and S/280 computers, type the two-digit device code followed by the H command, for example, 33H or 73H.

- When BOOT.SV asks for a filename, respond with the name of your system or of a stand-alone program such as DKINIT or BOOT. You can also use a directory specifier—a unit name followed by a colon—to specify a system or program on another disk or diskette. If you have bootstrapped from DP0, for example, and want to invoke SMALLSYS on DP1, your response would read DP1:SMALLSYS. Note that the directory specifier is always used to bootstrap a system on the fixed platter of a cartridge disk, for example, DH0F:SMALLSYS.

- Set the parameters of date and time for any operating system that you bootstrap. After the CLI prompt appears, you may want to set the computer's power switch to the LOCK position. This disables all other front panel switches on the machine, preventing accidental interference with the system.

With RDOS up and running, you can develop or run programs with the aid of utilities and CLI commands. The SMEM command assigns memory to foreground and background programs in a mapped system. The EXFG command executes a program in foreground memory, provided you have established its boundaries with the SMEM function in a mapped system, or in the program itself—with the RLDR /F and /Z address switches—in an unmapped system. See the *RDOS/DOS Command Line Interpreter* for details.

Bootstrapping From the CLI

You must have an RDOS system running to bootstrap from the CLI. Using the CLI command BOOT, you can start up another system on the same disk or introduce a new disk or diskette and bootstrap any system or program that resides on it. The BOOT command releases the current system—updating two essential directories, SYS.DR and MAP.DR, in the process—before starting up a new one.

In the following dialogue example, the user instructs the CLI to bootstrap another system on the same disk.

```
R
BOOT NEWSYS <CR>
MASTER DEVICE RELEASED
RDOS REV 7.10
DATE (M/D/Y)? 10 30 83 <CR>
TIME (H:M:S)? 13 45 <CR>
```

R

In the next example, the user attempts to bootstrap a system that resides on a different disk or diskette—one that has not been introduced to the system. The CLI returns a warning; and the user corrects the error with the INIT command before proceeding.

R

```
BOOT DP1:SMALLSYS (CR)
```

```
DIRECTORY NOT INITIALIZED: DP1:SMALLSYS
```

R

```
INIT DP1 (CR)
```

R

```
BOOT DP1:SMALLSYS (CR)
```

```
MASTER DEVICE RELEASED
```

```
RDOS REV 7.10
```

```
DATE (M/D/Y)? 11 15 83 (CR)
```

```
TIME (H:M:S)? 8 30 (CR)
```

R

Two alternatives to this dialogue are possible. In one, the user can issue the statement DIR DP1 followed by BOOT SMALLSYS. The CLI command DIR not only introduces DP1, but makes it the current directory; as a result, the INIT command and directory specifier (DP1:) are now redundant. In a second alternative, the statement BOOT DP1 can be substituted for INIT DP1. After releasing the master device (in this case, DP0), the bootstrap asks for a filename and starts up the system or program on DP1 that you specify.

Closing Down the System

To close down all directories in an orderly manner, you must release the disk or diskette that holds your RDOS system before turning off power to your computer and drives. The CLI command RELEASE, followed by the unit name of your master disk, is used for this purpose. The unit name is most likely to end in 0 or 4, because these drives are the only ones from which a loader program can read the bootstrap root in the first place, for example:

R

```
RELEASE DP0
```

```
MASTER DEVICE RELEASED
```

Alternatively, the CLI variable %MDIR%, which expands to the name of your master directory, can be used as follows:

R

```
RELEASE %MDIR%
```

```
MASTER DEVICE RELEASED
```

Both statements release the system and all other disk directories you were working with at the time. In addition, the directories SYS.DR and MAP.DR are updated and written to each disk or diskette, ensuring file integrity. (See the section entitled “Overview” in Chapter 5 for a discussion of these directories and their importance.)

There are two cases in which RDOS does not release the master device. First, when a foreground program is running—as would often be the case under mapped RDOS—the system tells you so and waits for you to issue CTRL-F from the background console; only then does RDOS respond to the RELEASE command. Second, when data has been spooled—that is, stored on disk for slow output devices—RDOS does not respond to the RELEASE command until the spooled data has been processed or deleted with the SPKILL command.

After closing down the system, press the rocker switch on a disk pack or cartridge drive to LOAD or STOP and wait for this indicator to light up; then turn off power to the drive and remove the cartridge or pack. Release and remove any diskettes before cutting power to their drives. Then turn off power to other peripherals and the computer.

Handling a System Failure

When the system terminates abnormally, you must write new system and map directories to all disks and diskettes that were initialized at the time. An abnormal termination is one that occurs before the master directory has been released and can be caused by the following:

- a hardware or software failure
- a power failure (if the system does not support powerfail options)
- an error in a user program
- forgetting to issue the CLI command RELEASE before turning off power to your computer and drives.

Whatever the cause, an abnormal termination can corrupt the contents of the SYS.DR and MAP.DR directories; unless these directories are updated during a normal release, they can misrepresent the locations of your files. For example, the directories could allocate the same disk space to several files when you next brought up the system. SYS.DR and MAP.DR must therefore be rewritten, involving the full initialization of every disk and diskette affected by the failure.

After an abnormal shutdown, disks can be fully initialized in two ways. First, return to Chapter 2 and execute all instructions required to bring up the RDOS starter system; then issue the CLI command INIT/F to all disks and diskettes that were initialized when the failure occurred.

Alternatively, bring up your tailored RDOS system from a back-up disk or diskette and issue INIT/F to all disks affected by the failure. Next, use the CLI commands MOVE or LOAD or the FLOAD utility to transfer your files and tailored system from the back-up medium to these disks. Then bootstrap your tailored system.*

Although more thorough, the first method results in considerable loss of work because it effectively destroys all files on each disk or diskette by overwriting the pointers to them. For this reason, the user may prefer to risk possible inaccuracies in the system and map directories rather than lose all data on the disk or diskette. The practice of backing up files, discussed later in this chapter, minimizes the ill effects of software failures and is strongly recommended for this reason.

Accessing Other Disks

Once your tailored system is up and running, you can access other disks using the command

```
INIT xxx
```

where INIT is the CLI command that introduces peripheral devices to RDOS and xxx is the unit name of the target disk or diskette. If this is a new disk, however, it must be prepared in at least two, and possibly four, ways before it can be introduced to the system:

- Full initialization with DKINIT is mandatory for new disks and diskettes.
- A bootstrap root is required on disks and diskettes that will hold RDOS systems or stand-alone programs.
- The system and map directories must be written to all new disk media with the CLI command INIT/F.
- A copy of BOOT.SV is required on disks and diskettes where RDOS systems or stand-alone programs will reside. (The save, overlay, and error files of the CLI should also be copied to a disk if you plan to run RDOS on it.)

This section summarizes each of these procedures and explains how to use link entries to save space. It assumes the disks you are using are properly formatted, that is, made and supplied by Data General.

*The MOVE, LOAD, and FLOAD commands, along with several back-up utilities, are discussed briefly under "Backing Up Files" later in this chapter. For full details, see the *RDOS/DOS Command Line Interpreter and RDOS/DOS Backup Utilities*.

Fully initialize a new disk or diskette by booting the disk initializer, DKINIT, and executing the FULL command. Use the instructions in Chapter 5, in the section entitled "FULL Command" as your guide. Issue DKINIT's STOP command when full initialization is complete, and restart the computer following the instructions given earlier in this chapter. Answer the query FILENAME? with the name of your tailored system and set its parameters of date and time. In general, this procedure is executed only once for each new disk or diskette.

Install a bootstrap root on the disk or diskette, including the fixed platter of a cartridge subsystem, if you plan to store systems or programs on it. First invoke the bootstrap installer with the statement

```
BOOT BOOT (CR)
```

Then execute the instructions listed in the section entitled "Installing the Bootstrap Root" in Chapter 2. Answer the query FILENAME? with the name of your tailored system and set its parameters of date and time.

Issue a system and map directory to a new disk or diskette after running DKINIT and, where appropriate, installing a bootstrap root. Use the CLI command INIT/F followed by a unit name, for example:

```
INIT/F DP0 (CR)
```

In most cases, this procedure need not be repeated after the new disk has been introduced to the system. Exceptions are discussed in Chapter 5.

Copy the file named BOOT.SV to a disk or diskette that will hold systems or programs. Use the CLI command MOVE with the /VERIFY switch followed by a unit and file name, for example:

```
MOVE/V DP0 BOOT.SV (CR)
```

If you plan to run RDOS on this disk, move the CLI as well, for example:

```
MOVE/V DP0 CLI.(OL SV ER) (CR)
```

It is strongly recommended that you copy BOOT.SV to the fixed portion of a cartridge disk. Later, depending on your application, you can also copy your tailored system and CLI to the fixed platter with the MOVE command. The files you move include SYS.SV and SYS.OL (substitute descriptive names where applicable), CLI.SV, CLI.OL, and CLI.ER, for example:

```
MOVE/V DP0F SYS.(OL SV) CLI.(OL SV ER) (CR)
```

Remember to use a directory specifier when booting a system from the fixed platter, for example:

```
FILENAME? DP0F: BASIC ___SYS (CR)
```

You can also store utilities on one disk or diskette and access them from another. The link entry, described in the next subsection, enables you to do so.

Using the Link Entry

A link entry allows you to access a file in any other user directory, as if the current directory contained a copy of it. Such an entry, created with the CLI command LINK, costs virtually nothing in file space while allowing you to devote an entire disk or diskette to program development, compilation, and loading. The following example demonstrates how to use link entries.

Problem: A user plans to write and compile FORTRAN IV programs on the fixed portion of a cartridge disk, DP0F. The removable platter, DP0, contains the RDOS system, CLI, and utilities, including the following program development tools:

- NSPEED.SV, the super text editor
- SPEED.ER, the editor's error interpreter
- FORT.SV, a FORTRAN IV interface
- FIV.SV, a FORTRAN IV compiler
- ASM.SV, an extended assembler
- FORT.LB, four FORTRAN IV libraries merged with the LFE utility
- RLDR.SV, the relocatable loader
- RLDR.OL, the loader overlays
- SYS.LB, the system library

The user would like to reserve the entire fixed platter for his programs, but cannot develop them without these utilities.

Solution: After bootstrapping his tailored system from DP0, the user performs the following steps:

1. Boots the disk initializer, DKINIT, and executes its FULL command on the fixed platter (see Chapter 5).
2. Restarts the computer by executing the program load steps for his hardware option and bootstraps his system again.
3. Types BOOT BOOT and installs a bootstrap root on the fixed platter according to the instructions in Chapter 2.

4. Proceeds according to the following dialogue.

First the system and map directories are written to the blank fixed platter, DP0F.

```
INIT/F DP0F(CR)
```

R

Then the platter receives a copy of BOOT.SV.

```
MOVE/V DP0F BOOT.SV (CR)
```

R

The user makes DP0F the working directory and creates links from this platter to the necessary files on DP0. Each entry consists of the LINK command followed by the name of the link and the path to the necessary utility or file.

```
DIR DP0F (CR)
```

R

```
LINK NSPEED.SV DP0:NSPEED.SV (CR)
```

R

```
LINK SPEED.ER DP0:SPEED.ER (CR)
```

R

```
LINK FORT.SV DP0:FORT.SV (CR)
```

R

```
LINK FIV.SV DP0:FIV.SV (CR)
```

R

```
LINK ASM.SV DP0:ASM.SV (CR)
```

R

```
LINK FORT.LB DP0:FORT.LB (CR)
```

R

```
LINK RLDR.SV DP0:RLDR.SV (CR)
```

R

```
LINK RLDR.OL DP0:RLDR.OL (CR)
```

R

```
LINK SYS.LB DP0:SYS.LB (CR)
```

R

Now the utilities on DP0 can be accessed from the fixed platter with a simple statement such as FORT, because the link entry, named FORT.SV, expands to the pathname DP0:FORT.SV. For more information on the LINK command and its complement, UNLINK, see the *RDOS/DOS Command Line Interpreter*.

Backing Up Files

As mentioned earlier, valuable data and programs can be lost when a system terminates abnormally. The practice of backing up files minimizes such losses, as well as the work involved in recovering from them.

This section summarizes the procedures for backing up your system, other programs, and data files on diskette and magnetic tape media. Other methods of file back-up, listed below, can be used in place of the ones discussed here. Whatever your choice, develop a system of regular use that adequately safeguards your investment of labor and time.

DUMP/LOAD. DUMP is a CLI command that produces logical copies¹ of files or directories and puts them on disk or diskette or tape back-up media. DUMP is slower to execute than the back-up utilities, but allows greater selectivity. The CLI command LOAD moves previously dumped files from the back-up medium to the user's working directory. Both commands are described in the *RDOS/DOS Command Line Interpreter*.

FDUMP/FLOAD. The FDUMP utility produces logical copies of files on hard disk and dumps them to magnetic tape. The FLOAD utility moves previously dumped files from back-up tape to hard disk. Both utilities, as well as the ones that follow, are described in *RDOS/DOS Backup Utilities*.

DDUMP/DLOAD. The DDUMP utility produces logical copies of hard-disk files and dumps them to diskette. The DLOAD utility moves previously dumped files from back-up diskette to hard disk.

BURST/YBURST. These back-up and restore utilities produce physical copies² of whole disks on magnetic tape, restore these copies to hard disk, and write a disk image to another disk of the same type. BURST is used with standard NOVA or ECLIPSE peripherals and YBURST with peripherals from the Microproducts line.

¹ A *logical copy* of a disk or diskette contains its file descriptors and data, but does not duplicate its structure—that is, the addresses where data were originally stored are not preserved. A logical copy can be used on another system or even a different machine.

² A *physical copy* of a disk or diskette preserves its structure and can only be restored to the original medium. Physical dumps execute more quickly than logical ones.

Diskette Back-ups

The following subsections describe the preparation of your diskettes and the backing up of RDOS and selected files.

Preparing Your Diskettes

Follow these steps to prepare one or more diskettes for back-up:

1. Locate the diskette drive labeled DP1 or DE1. If it features a unit-select knob, set it to 1. If it does not, look for a metal toggle switch on or behind the front panel of the companion fixed-disk drive, if any, and set it to NRM or DSK0/FPY1.
2. After powering up your equipment, bootstrap RDOS if it is not already running.
3. Working with a properly formatted diskette (supplied by Data General), remove the outer storage envelope and cover the write-protect hole with opaque tape. Wrap the tape over the edge to cover both sides of the hole. Repeat this step for each back-up diskette that you plan to prepare; then insert one of them in the diskette drive.
4. Invoke the disk initializer by typing BOOT DKINIT. Enter the model number and unit name of the diskette. (See Table 4.2.) Then execute the DKINIT's command FULL according to the instructions in Chapter 5. To initialize more than one diskette, remove the first and insert a second, making sure that its write-protect hole is covered; issue the FULL command; and repeat the dialogue.

NOTE: Under normal operating conditions, one diskette is never replaced by another until the drive has been released.

Issue the STOP command when all diskettes have been initialized.

Diskette Type	Model Number	Unit Name
NOVA/ECLIPSE double-density	6097	DP1
NOVA/ECLIPSE single-density	6030	DP1
Microproducts double-density	6096	DE1

Table 4.2 Diskette identifiers for back-up

5. Press the rocker switch on the disk drive to LOAD, STOP, or START. Then place it in the READY position and wait for the indicator to glow. (This action repositions the read/write heads at the beginning of the disk, where they must be to read BOOT.SV.)

6. Execute the appropriate program load steps for your hardware option. Answer the query FILENAME? by typing BOOT.
7. Install a bootstrap root on at least one diskette. (This diskette will hold the back-up copy of your tailored system.) Use the instructions in Chapter 2 in the section entitled "Installing the Bootstrap Root," as a guide. Remove the first diskette, insert a second, and repeat this dialogue for each diskette that will hold system or user programs.
8. Again, bootstrap your tailored system. When the CLI prompt appears, issue the command INIT/F followed by the unit name of your diskette. If you are preparing more than one, remove this diskette, insert another, and repeat the INIT/F command.
9. Move a copy of BOOT.SV to the diskette you will use to back up your system. Issue the CLI command MOVE with the /VERIFY switch followed by a unit and filename, for example, MOVE/V DP1 BOOT.SV. Remove the diskette, insert another, and repeat this step for each diskette that will hold system or user programs.

Backing Up RDOS

Your tailored system can be copied to any diskette that was prepared according to the nine steps just described. The following instructions assume that you have taken these steps and that the CLI prompt appears on your console.

Issue the CLI command MOVE with the /VERIFY switch followed by the unit name of your diskette and the system's default or descriptive filename, for example:

```
MOVE/V DP1 SYS.(OL SV) (CR)
```

```
SYS.OL
```

```
SYS.SV
```

Use the same command line format to move the CLI, for example:

```
MOVE/V DP1 CLI.(OL ER SV) (CR)
```

```
CLI.OL
```

```
CLI.ER
```

```
CLI.SV
```

With the RELEASE command, disconnect the back-up diskette, for example:

```
RELEASE DP1 (CR)
```

Remember to close down your RDOS system before cutting power to the computer and drives.

Remove the back-up diskette from its drive. Using a felt-tipped pen, write "RDOS System Back-up" on a label and affix it to the diskette, leaving the timing hole uncovered. Return the diskette to its outer envelope and store it safely.

Although RDOS can be bootstrapped from a hard disk only, you can insert this diskette in drive 0 and program load from it, specifying a disk-based RDOS system if necessary.

Backing Up Selected Files

To back up other files, prepare a diskette according to the steps described in the section entitled "Preparing Your Diskettes" and execute the following instructions. Consult *RDOS/DOS Command Line Interpreter* to learn the full capabilities of the MOVE command.

At the CLI prompt, issue the INIT command to introduce your back-up diskette to the system, for example:

```
INIT DP1 (CR)
```

To back up files selectively, issue the MOVE command in combination with global and local switches, for example:

```
MOVE/V/K DP1 2-14-83/A (CR)
```

This statement moves all files in the current directory created on or after February 14, 1983—except link files—to the backup diskette and verifies the move at your console.

Alternatively, you can back up all files in the current directory, including permanent ones, with the MOVE command and global /A switch, for example:

```
MOVE/V/A DP1 (CR)
```

Using the DIRECTORY command, change the current directory on your system or source disk to another user directory if you would like to back up its contents, for example:

```
DIR INVENTORY (CR)
```

Back up the files in the current directory (called INVENTORY in this case) with the MOVE command and switches of your choice, for example:

```
MOVE/V/R/D DP1 (CR)
```

Continue to change directories and back up their contents as needed.

With the RELEASE command, disconnect the back-up diskette from the system when it contains all the files you want to save, for example:

RELEASE DP1 (CR)

(Remember to release your tailored system as well before cutting power to the computer.)

Remove the back-up diskette from its drive, label it with a description of its contents, and store it safely, away from strong magnetic fields. This diskette can be used repeatedly for file back-up until its storage space is exhausted. In general, selective back-ups are recommended on a daily basis; all files should be backed up each week.

Magnetic Tape Back-ups

The following subsections describe the preparation of your magnetic tape and the backing up of RDOS and selected files.

Preparing Your Tape

As mentioned earlier, the CLI command DUMP copies one or more disk files to a back-up medium and places them next to each other in one destination file. On magnetic tape, this file is identified by a number ranging from 0 through 99: the first file on the tape is 0, the second 1, and so forth. Use the DUMP command and its global and local switches to perform sequential backups from disk to numbered files on tape.

Follow these steps to prepare a reel of magnetic tape for back-up:

1. After powering up your equipment, bootstrap RDOS if it is not already running.
2. Locate a tape unit on the first controller and dial 0 on its unit-select knob. Make sure that no other unit has this number.
3. Use a blank or scratch reel of magnetic tape. If no plastic write-enable ring is present, insert one in the groove at the back of the reel.
4. Mount and thread the tape on drive 0. Press RESET and then LOAD and place the unit on line.
5. Introduce the tape unit to RDOS by typing INIT MT0.

Backing Up RDOS

Execute the following commands to make a backup copy of your system and CLI.

At the CLI prompt, issue the CLI command DUMP with the /VERIFY switch and include in the command line the tape unit and file numbers and the system's default or descriptive filename, for example:

```
DUMP/V MT0:0 SYS.(OL SV) (CR)
```

```
SYS.OL
```

```
SYS.SV
```

Use the same format to move the CLI and bootstrap routine, for example:

```
DUMP/V MT0:0 CLI.(OL ER SV) BOOT.SV (CR)
```

```
CLI.OL
```

```
CLI.ER
```

```
CLI.SV
```

```
BOOT.SV
```

Release the tape drive by typing

```
RELEASE MT0 (CR)
```

(This command also rewinds the tape.) Remember to close down your RDOS system before cutting power to the computer and drives.

Remove the back-up tape from its drive by pressing RESET followed by UNLOAD. Using a felt-tipped pen, write "File 0: RDOS System Back-up" on a label and affix it to the reel; remove the plastic write-enable ring; and store the tape safely, away from strong magnetic fields.

Although RDOS can only be bootstrapped from a hard disk, you can mount this tape on drive 0 and program load from it, specifying a disk-based RDOS system if necessary.

Backing Up Selected Files

To back up other files, prepare a tape according to the steps described in the section entitled "Preparing Your Tape" and execute the following instructions. Consult the *RDOS/DOS Command Line Interpreter* to learn the full capabilities of the DUMP command.

At the CLI prompt, issue the DUMP command with switches to back up all files created or modified on or after a given date. Store these files in the first numeric file on tape. For example, the statement

```
DUMP/V/K MT0:0 6-26-83/A (CR)
```

copies to tape file 0 only those files that were created or modified on or after June 26, 1983.

Type the following to close down the drive and rewind the tape:

```
RELEASE MT0 (CR)
```

(Remember to close down your RDOS system before cutting power to the computer and drives.)

Remove the back-up tape from its drive by pressing RESET and then UNLOAD. Using a felt-tipped pen, record the tape file number and date covered by this back-up on a label and affix it to the reel; remove the plastic write-enable ring; and store the tape safely, away from strong magnetic fields.

One day later, using the same tape as before, repeat the steps listed in the section entitled "Preparing Your Tape" and then execute the DUMP and RELEASE commands as described below.

With the DUMP command and its switches, copy all files created or modified on or after today's date to the second numeric file on this tape. Based on the previous example, your statement would be as follows:

```
DUMP/V/K MT0:1 6-27-83/A <CR>
```

All files created or modified on or after June 27, 1983, would be stored in the tape file 1 as a result.

Then, at the CLI prompt, type the following:

```
RELEASE MT0 <CR>
```

Repeat this back-up procedure each day, incrementing the date and tape file number by 1 until storage space is exhausted. Keep a record of the file number and date covered by each back-up to avoid overwriting the contents of any tape file. And always release your RDOS system before closing down your hardware.

Tuning Your System

The RDOS tuning option, specified during system generation, measures the performance of your tailored system against the demands made on it by your application. SYSGEN uses the resulting data, stored in the file *sysname.TU* (where *sysname* is the default or descriptive name you used earlier), to configure a more efficient RDOS system.

This section explains how to use the tuning feature. It assumes that you have already tailored an RDOS system to the software parameters (that is, stacks, cells, and buffers) you feel will support your application.

Follow these steps to tune and reconfigure your system.

1. Bootstrap RDOS if it is not already running, and set the parameters of date and time.
2. After the CLI prompt appears (*R*), issue the command TUON to begin recording information in the tuning file (*sysname.TU*).

3. Run RDOS long enough to supply the tuning file with adequate information on your application's requirements. Take several days or weeks, if necessary. (Remember to type TUOFF before releasing RDOS and TUON after restarting RDOS.)
4. Turn the tuning feature off with the command TUOFF. If you want to review the contents of the tuning file, type the CLI command TPRINT followed by a space, the name of your system, and the suffix .TU. Figure 4.1 shows a sample printout of a tuning file.

SYSTEM TUNING REPORT FOR NEWSYS					10/09/83	12:48:47
	NUMBER IN SYSTEM	TOTAL REQUESTS	NUMBER OF FAULTS	PERCENTAGE FAULTED		
STACKS	1	33680	120	0 %		
CELLS	3	37956	0	0 %		
BUFFERS	6	25928	6666	26 %		
OVERLAYS	64	50741	2115	4 %		

Figure 4.1 Sample printout of tuning file

DG-09540

5. Invoke SYSGEN as follows. (Substitute any unique name for NEWSYS and the name of your current system for SYS.)

```
SYSGEN NEWSYS.<SV/S SG/V LM/L>SYS.<TU/T SG/A> <CR>
```

This statement instructs SYSGEN to build a new system, NEWSYS, from the dialogue contained in SYS.SG, where SYS is the name of the system currently running. The statement further tells SYSGEN to supply more efficient answers to the stack, cell, and buffer questions based on the information in tuning file SYS.TU.

Note that a system tuned in this way automatically receives the same features, including tuning, as its predecessor; stacks, cells, and buffers are the only exceptions. SYSGEN simply constructs the new system from the script and tuning files with no further input from the user.

Suppose, however, that because of critical memory requirements you want to tune a system and reconfigure it to omit the core dump and tuning features, all at the same time. In this case, you would execute SYSGEN as follows, substituting any unique name for NEWSYS, and the name of your current system for SYS:

```
SYSGEN NEWSYS.<SYS/S SG/V LM/L> SYS.TU/T <CR>
```

The resulting dialogue is much like that described in Chapter 3, with one exception: this statement tells SYSGEN to recommend the most efficient number of stacks and extra cells and buffers given the information in the tuning file. Thus, SYSGEN might advise

```
ENTER NUMBER OF STACKS (1-10) 4
```

where 4 is the number recommended. You may follow (by typing CR) or ignore (by typing a different answer) this advice; and, at the same time, you can reconfigure other system features as needed.

6. Allow some time for SYSGEN to build the new system. The CLI prompt (*R*) will appear when the process is completed. Make a hard copy of the resulting script file by typing PRINT NEWSYS.SG if you have a line printer or TYPE NEWSYS.SG on a hard-copy terminal. Substitute the unique name of your tuned system for NEWSYS.
7. Delete the tuning file by typing DELETE SYS.TU, substituting the name of your original system for SYS.
8. Bring up the new system with the CLI command BOOT, for example, BOOT NEWSYS. Set the parameters of date and time. Then run the tuned system with your application to test its performance.
9. You can replace the old system with the new one by invoking the RDOS starter system, for example, BOOT BOOTSYS. Then delete the original save, overlay, and script files of the system and load map files with the statement

```
DELETE/V SYS.(SV OL SG LM) (CR)
```

where SYS is the name of the old system. Finally, rename your new system with the statement

```
RENAME NEWSYS.SV SYS.SV NEWSYS.OL
```

```
SYS.OL NEWSYS.SG SYS.SG NEWSYS.LM
```

```
SYS.LM
```

where NEWSYS is the name you gave to the new system and SYS the name given your original system. (The up arrow, `↑`, allows users to continue a CLI command on a new line before terminating it.) You can now release the starter system and bootstrap RDOS under its new name, for example, BOOT SYS.

Patching Your System

Once you have tailored an RDOS system, you may have occasion to fix or enhance it with patches. (Data General distributes patches periodically in the form of updates.) This section explains patching in general terms.

A *patch* is a one-word change to a save (.SV) or overlay (.OL) file. Data General releases current patches, or changes, with its system software on diskette or magnetic tape. An update notice informs users of these changes, which most often pertain to the operating system, although they can apply to utility programs as well.

In general, Data General patches released at one revision level should not be applied to software released at another.

In addition to the save and overlay files of which RDOS is composed, system patching involves these files:

- a Data General-supplied patch file¹
- a load map file
- the utility PATCH.SV

A *patch file*—whether supplied by Data General or created by the user with the utility ENPAT.SV²—specifies the type of file (save or overlay) to be changed; the location, or address, to be changed; the current contents of this location; the new contents of this location, that is, the change itself; and conditions under which this change should or should not be made. A patch file is a text file; it can be modified with a text editor if desired.

A *load map file* contains the location of every module in a save or overlay file. The SYSGEN utility creates a load map file only if you request one with the local /L switch. (You may recall using this switch in the statement used to invoke SYSGEN, for example, SYSGEN NEWSYS.(SV/S SG/V LM/L).)

A load map of RDOS translates options selected during system generation into a listing of modules and module locations unique to your system. This information is used to create or modify a patch file and is required in order to execute the PATCH utility, described next. Readers are therefore urged to save all load map files—perhaps on a back-up diskette. *RDOS/DOS Command Line Interpreter* explains how to do so with the local /L switch.

¹All patch files end with the .PF suffix.

²ENPAT.SV creates a patch file based on input from the user. It is used primarily for fixing or enhancing user programs without recompiling and reassembling them.

The utility PATCH.SV installs patches in a save or overlay file. PATCH.SV draws on information contained in a Data General-supplied or user-created patch file—information that must be compared with a load map file to ensure its accuracy. The utility is most often used to incorporate system updates supplied by Data General. However, used with its complement, ENPAT.SV, PATCH also offers an alternative to lengthier methods of program debugging. Both utilities are fully explained in *RDOS/DOS Debugging Utilities*. The Release Notice that accompanies your software describes any patches you may have received.

The Disk_INITIALIZER

This chapter explains the full functionality of the disk initialization program, DKINIT. It begins with an overview of the program and then explains each of DKINIT's nine functions in detail. Error messages and recovery procedures are presented in Tables 5.2 and 5.4 through 5.7.

All discussions assume you are using properly hardware formatted disks or diskettes—that is, distributed by Data General.

Overview

DKINIT is an interactive stand-alone program that readies a disk or diskette to hold system and user software safely. Stored under the filename DKINIT.SV on your Data General release tape or diskette, this program is essential to the processes of creating new systems, introducing new disks, duplicating (backing up) data, and maintaining the integrity of your disk media.

DKINIT performs the following tasks for all disk media:

- bad block testing
- bad block accounting
- disk or diskette identification

Bad block testing detects any blocks on a disk or diskette that will not faithfully record and retain information. This test is especially important because even one bad block on a single-density diskette renders the diskette unusable. Moreover, although RDOS can tolerate bad blocks on a hard disk or double-density diskette, it cannot run if any block from 0 through 6 is flawed.

In five passes over the recording surface, DKINIT writes and then reads up to five unique patterns, each composed of 16 bits. As a group, these patterns are designed to exercise all possible combinations of 0 and 1 in any two adjacent bits. (The patterns are shown later in Table 5.3.) Every disk block available to system and user software is tested in this way. A block is considered “bad” if it deviates from the original pattern when DKINIT attempts to read it.

Bad block accounting enables RDOS and its users to avoid unusable disk blocks by recording their locations and re-

serving a remap area—an area of contiguous usable disk blocks—that RDOS can access in place of the defective blocks. DKINIT performs these functions for hard disks and double-density diskettes only, because bad blocks are not tolerated on single-density diskettes.

DKINIT describes each flawed block it encounters in a bad block table. This table resides in main memory until, the bad block test completed, DKINIT writes the table to block 4 on your disk or diskette. (If block 4 itself is unusable, RDOS cannot run on this disk.) The table occupies a place in memory whenever the disk is in use, providing the executing software with immediate access to its contents. DKINIT is commonly used to update these contents when new bad blocks are discovered by the user.

If DKINIT finds one or more bad blocks, it searches among the highest addresses of your disk or diskette for a suitable remap area. Alternatively, the program allows you to locate the remap area elsewhere, leaving the top addresses free for user programs. DKINIT provides a default remap area slightly larger than the number of bad blocks found. The size and starting address of this area are added to the bad block table in block 4. Later, when the operating system runs, it will be remapped, or rerouted, to this area of usable blocks whenever it attempts to access a flawed block on the disk.

Disk identification supplies the operating system with a disk's model and characteristics, its controller type, and its frame size—that number of blocks allocated for the system directory. DKINIT gathers this information and puts it in block 3 of your disk or diskette.

DKINIT begins all interactive sessions with a request for the model number and unit name of your disk. Using your answers, the program defines such characteristics as the number of tracks per cylinder and sectors per track; the checksum; and the number of blocks for this disk. The frame size, which influences the efficiency of the file access capabilities of your system, is set either by default—according to the type of disk—or by you, according to the number of user (sub)directories you require.

Bad block testing, bad block accounting, and disk(ette) identification support the creation of the master allocation (MAP.DR) and system (SYS.DR) directories, without which

no RDOS system can run. (The INIT/F command, which instructs RDOS to build these directories, is always issued after the FULL, REMAP, and FRAME commands for this reason.)

The master allocation directory—a file of contiguous bits corresponding to each disk block—monitors and controls the availability of every block on the disk by setting to 1 those bits whose corresponding blocks are in use and by setting to 0 all bits whose corresponding blocks can be accessed by the system or the user. The system directory contains file descriptors, or *pointers*, that enable the operating system to locate files on the disk.

MAP.DR relies on DKINIT to test and account for bad blocks so that it can prevent all software from using those blocks, while SYS.DR depends on DKINIT for the positioning of its descriptor blocks and ease of file access. Together, these directories and the functions of the disk initializer help prevent software failures and ensure the efficient operation of your RDOS system.

DKINIT Functions

The disk initializer performs the nine functions summarized in Table 5.1.

Command	Function
FULL	Reads and writes test patterns to disk or diskette, checking surface for flaws; records bad blocks in bad block table; sets frame size; destroys existing files. This function is required for all new disks.
PARTIAL	On hard disks or double-density diskettes only, inspects disk for bad blocks and records them in bad block table. Does not destroy files.
TEST	Inspects disk for bad blocks without recording them in bad block table. Does not destroy existing files.
LIST	Describes disk type and displays bad block information.
DISK	Restarts the disk initializer at the DISK DRIVE MODEL NUMBER? query.
FRAME	For hard disks or double-density diskettes only, defines frame size for the RDOS system directory, SYS.DR.
REMAP	For hard disks or double-density diskettes only, establishes a new remap area for bad block information. INIT/F must be issued after this command.
ENTER	For hard disks or double-density diskettes only, enters bad block information in bad block table.
STOP	Halts the disk initializer and the computer.

Table 5.1 DKINIT commands and their functions

Regardless of the function you intend to use, DKINIT begins each dialogue with the following questions after you invoke it with the CLI command BOOT.

DKINIT REV 7.10

DISK DRIVE MODEL NUMBER?

DISK UNIT?

Tables 1.6 and 1.7 in Chapter 1 contain the model numbers and unit names of all RDOS-supported disk and diskette drives. Once you have loaded and generated an RDOS system, the disk initializer can run from any valid drive/controller combination. If you make a typing mistake, type CTRL-A and DKINIT will repeat its question. Table 5.2 shows the error messages you could receive from the main program.

Error Message	Corrective Action
UNKNOWN DRIVE TYPE	Supply a valid (RDOS-supported) disk or diskette model number.
INVALID DEVICE NAME PROGRAM CANNOT CONTINUE—ABORTING	Check your entry against the valid unit names in Tables 1.5 and 1.6 and change it accordingly. (After reporting this message, DKINIT aborts and restarts at the question <i>DISK DRIVE MODEL NUMBER?</i>)
DISK ID INCORRECT— ABORTING	DKINIT performs no functions for this disk or diskette until it has been fully initialized. Execute the FULL command and then proceed.

Table 5.2 Error messages from the main program

DKINIT next asks

COMMAND?

The following subsections describe each command you can enter in response to this question, along with the dialogues and actions that result.

FULL Command

The FULL command causes a full initialization, or software format, of a disk or diskette. It combines the functions of the FRAME, REMAP, and ENTER commands described later and analyzes the surface of the disk. The command is executed on virtually every new disk or diskette.

INIT/F, an RDOS CLI command, must always be issued after a full initialization. It establishes the original master allocation and system directories on a new disk or diskette, and overwrites these directories on a used one. In doing so, INIT/F effectively destroys any existing file structure. Therefore, neither the FULL nor INIT/F functions should be performed on disks that hold valuable data.

NOTE: *Although not apparent to the user, the CLI's INIT/F command creates an empty file on hard disks and double-density diskettes and reserves this space for the system overlays. The file is contiguous, permanent, and attribute-protected. It cannot be deleted by the user and is required for the partial initialization of a disk from magnetic tape.*

The FULL command instructs DKINIT to write and read the patterns shown in Table 5.3 to every word of every sector on the disk, which permits the detection of variations between the recorded and the original pattern.* This is the only apparent function executed by the FULL command for single-density diskettes.

Pattern Number	Bit Configuration	Octal Value
1	1101101101101101	155555
2	1010101010101010	125252
3	0101010101010101	052525
4	0000000000000000	000000
5	1111111111111111	177777

Table 5.3 DKINIT test patterns

For hard disks and double-density diskettes only, the FULL command allows you to declare additional flawed blocks you may have discovered when running the hardware formatter, DTOS. Then, once all bad blocks have been accounted for, the FULL command allows you to declare a remap area size and starting address of your choice. DKINIT also provides a default remap area of at least one usable disk block for every flawed one. Finally, the FULL command presents a default frame size, along with the minimum and maximum number of blocks you can set aside for the

*A sector, in Data General parlance, is equivalent to one disk block in which 256 words are apparent to software. Only this 256-word area of the sector is tested by DKINIT.

system directory, SYS.DR. (Frame size and remapping are discussed in more detail later in this chapter.)

The following dialogue is typical when the FULL command is executed on a hard disk or double-density diskette. A dialogue concerning a single-density diskette ends when all five test patterns have run successfully. (DKINIT automatically sets the frame size of a single-density diskette to 5.) Table 5.4 shows the error messages returned when using the FULL command.

Error Message	Corrective Action
ILLEGAL NUMBER OF PATTERNS	Specify a number between one and five.
CRITICAL DISK BLOCKS ARE BAD.	Reformat the disk with DTOS, the hardware formatter.
RDOS CANNOT BE BUILT, ABORTING	
TOO MANY DISK ERRORS TO COMPLETE	Reformat the disk with DTOS, the hardware formatter.

Table 5.4 Error messages from FULL command

COMMAND?

Specify a full initialization by typing FULL.

COMMAND DESTROYS ANY PREVIOUS

RDOS DISK STRUCTURE. RDOS

INIT/F MUST BE DONE ON DISK

AFTER COMMAND. TYPE CONTROL-A

NOW TO ABORT WITHOUT LOSS

If the disk or diskette in question holds valuable data, abort this session by typing CTRL-A.

Because RDOS tolerates no bad blocks on a single-density diskette, the initializer analyzes the surface of the diskette with no fewer than five test patterns. The next question is asked of hard disk and double-density diskette users only.

NUMBER OF PATTERNS TO RUN (1-5)?

The risk to software increases with the number of patterns omitted from the bad block test. For this reason, an answer of 5 is strongly recommended.

*** PATTERN #1 (155555) ***

*** PATTERN #2 (125252) ***

*** PATTERN #3 (052525) ***

*** PATTERN #4 (000000) ***

*** PATTERN #5 (177777) ***

*** ALL PATTERNS RUN ***

The full initialization of a single-density diskette is complete at this point. DKINIT has given the diskette a frame size of 5. The program displays the drive head, sector, cylinder, and bad block locations at your console if it encounters a bad block on a hard disk or double-density diskette

DO YOU WISH TO DECLARE ANY BLOCKS BAD

THAT ARE NOT ALREADY IN THE BAD BLOCK TABLE?

Answer NO unless you want to declare flawed blocks that DKINIT has not already detected. The program asks you to supply a bad block number in octal form if you answer YES.

DEFAULT REMAP AREA IS x BLOCKS LONG.

IT NEEDS TO BE AT LEAST y BLOCKS LONG

DKINIT calculates y by adding the number of flawed blocks in its bad block table to the number declared by the user.

REMAP AREA SIZE (TYPE RETURN FOR DEFAULT)?

If DKINIT recommends a number greater than the default value, enter a number at least as large. The default answer is recommended in cases where most or all disk blocks appear sound.

REMAP AREA START BLOCK NUMBER

(TYPE RETURN FOR DEFAULT)?

Unless directed otherwise, DKINIT locates the remap area among the highest physical addresses on the disk or diskette. The default answer is recommended except in the cases described in the section entitled "REMAP Command."

DEFAULT FRAME SIZE IS xx

MIN IS 1 AND MAX IS yyy

DISK FRAME SIZE (TYPE RETURN FOR DEFAULT)?

DKINIT arrives at the default (xx), and maximum (yyy) frame sizes based on the disk type you specified earlier.

The default answer is recommended if you are unable to anticipate your directory structure at this time. Tailored responses to this question are discussed in the section entitled "FRAME Command."

FULL INIT COMPLETE

COMMAND?

DKINIT is ready to execute another command.

PARTIAL Command

The PARTIAL command is routinely used to maintain disks that have already been introduced to the system. It identifies bad blocks by their head, sector, cylinder, and physical location numbers at your console and enters them in the original bad block table on the disk.

Unlike the FULL command, the PARTIAL command performs a read-only analysis of the recording surface and does not require that the CLI's INIT/F command be issued afterward. PARTIAL therefore does not destroy files, although it may truncate those containing bad blocks as it makes entries in the bad block table. If new entries cause this table to overflow, you must execute the FULL command to construct a new bad block table.

The following dialogue occurs during partial initialization. Table 5.5 shows possible error messages.

Error Message	Corrective Action
UPDATING DISK FORMAT REV. NUMBER TO CURRENT	None.
NEW ERRORS FOUND ON DISK. UPDATING BAD BLOCK TABLE TO INCLUDE THEM	None.
NOT ENOUGH ROOM FOR UPDATE. SUGGEST FULL INIT	Execute FULL command on the disk or diskette.
CRITICAL DISK BLOCKS ARE BAD. SUGGEST FULL INIT	Reformat the disk with DTOS, or reinitialize it with the FULL command.

Table 5.5 Error messages from PARTIAL command

COMMAND? PARTIAL (CR)

*** CHECKING FOR BAD BLOCKS ***

Bad blocks are reported in the following format:

HEAD SECTOR CYLINDER BAD BLOCK NUMBER

Consult your release notice for full details on bad block reporting as performed by this command. If no bad blocks are found, PARTIAL returns this message:

NO NEW ERRORS DETECTED ON DISK

PARTIAL INIT RUN COMPLETE

COMMAND?

DKINIT is ready to execute another command.

TEST Command

The TEST command instructs DKINIT to perform a read-only surface analysis of a disk or diskette without recording flawed blocks in the bad block table. Therefore, the TEST command does not jeopardize the existing file structure and need not be followed by INIT/F.

Like the PARTIAL command, TEST is most often used to monitor the integrity of disks already in use. It is most helpful for checking a disk's compatibility with different drives. Its error messages report any bad blocks found on the disk.

A typical dialogue follows.

COMMAND? TEST (CR)

*** CHECKING FOR BAD BLOCKS ***

Bad blocks are reported in the following format:

DISK ERROR—BAD BLOCK= 15233

Consult your Release Notice for full details on bad block reporting as performed by this command. If no bad blocks are found, TEST returns this message:

NO NEW ERRORS DETECTED ON DISK

PARTIAL INIT RUN COMPLETE

COMMAND?

DKINIT is ready to execute another command.

LIST Command

The LIST command instructs DKINIT to display at your system console the drive and controller type, frame and remap area sizes, starting block of the remap area, and locations of bad blocks, if any, for this disk or diskette. Bad blocks are reported in the same format used for the PARTIAL and TEST commands. Unlike these commands, however, LIST does not perform surface analysis. The LIST command can be issued for any disk or diskette; leaves the existing file structure intact; and does not require that INIT/F be issued afterward.

Two sample dialogues follow. The first involves a Micro-products fixed disk, and the second, a NOVA/ECLIPSE single-density diskette.

COMMAND? LIST (CR)

6105 DISK DRIVE ON UNIT DE0

FRAME SIZE = 53

REMAP AREA SIZE = 12

REMAP AREA START BLOCK NUMBER = 23064

NUMBER OF BAD BLOCKS = 2

HEAD SECTOR CYLINDER BAD BLOCK NUMBER

000001 000007 000606 022243

000001 000003 000627 023077

COMMAND? LIST (CR)

6030 DISK ON UNIT DP0

FRAME SIZE = 5

THERE ARE NO BAD BLOCKS

COMMAND?

DKINIT is ready to execute another command.

DISK Command

The DISK command instructs DKINIT to loop back to its first question, allowing you to identify and work with a new disk or diskette. A sample dialogue follows.

COMMAND? DISK (CR)

DKINIT REV 7.10

DISK DRIVE MODEL NUMBER? 6060 (CR)

DISK UNIT? DZ0 (CR)

COMMAND?

DKINIT is ready to execute another command.

FRAME Command

The FRAME command instructs DKINIT to reserve a specified number of disk blocks for the system directory, SYS.DR. It applies to hard disks and double-density diskettes only.* The CLI command INIT/F, which effectively destroys any existing file structure, is always issued after the FRAME command.

The system directory contains a list of user file descriptors (UFD), which enable RDOS to locate the files and directories on your disk or diskette. Each UFD occupies 18 (decimal) words of a data block and describes the characteristics of a file—for example, its name, attributes, size, location, and date of last access. Each block of the system directory can contain up to 11 UFDs; any overflow slows response time considerably because RDOS must search for and examine the excess frames.

Table 5.6 shows the minimum, maximum, and default frame sizes DKINIT allows for each RDOS-supported disk. A frame size smaller than the default is recommended if you plan to have many user directories composed of relatively few files. Conversely, a frame size larger than the default is suggested when a few user directories will hold many files. The filename and extension characters you use are also important when considering a frame size because they affect the distribution of UFDs in the system directory. Distribution is denser—speeding access, but increasing the likelihood of overflow—when the descriptors contain similar characters, and more scattered when they do not. Generally, the best frame size is approximately one-tenth the number of files that will occupy any directory, user or global (such as DP0), on the disk. The frame size should be a prime number—that is, a number only divisible by itself or by one.

*Single-density diskettes automatically receive a frame size of 5 during full initialization.

Disk Type	Model No.	No. of Octal Blocks	Frame Size		
			Min.	Max. ¹	Default
Single-density diskettes					
	6030	1142	1	77	5
Double-density diskettes					
	6096/6097	4632	1	154	5
Cartridge disks					
	4047A/	11410/	1	406	37
	4047B	23020			
	4234	23072	1	816	53
	6045/6095	23072	1	816	53
	6070	46172	1	816	83
NOVADISKS					
	6001/6005	772	1	1023	3
	6002/6006	1772	1	1023	5
	6003/6007	3772	1	1023	11
	6004/6008	5772	1	1023	17
Fixed Disks					
1-Mbyte	6063	3772	1	816	37
2-Mbyte	6064	7772	1	816	37
5-Mbyte	6220/6225	23102	1	490	53
12.5-Mbyte	6099/6102	57772	1	768	53
15-Mbyte	6222/6227	71322	1	490	53
25-Mbyte	6103/6105	137772	1	1536	53
50-Mbyte	6234	1077002	1	4075	83
74-Mbyte	6160	2031223	1	4115	83
148-Mbyte	6161	4062454	1	8230	113
Disk Packs					
50-Mbyte	6067	1077002	1	4075	83
96-Mbyte	6060	2156022	1	7809	83
190-Mbyte	6061	5125662	1	15485	113
277-Mbyte	6122	10042421	1	15485	127

Table 5.6 Frame sizes for RDOS-supported disks

¹The frame size should be a prime number. To arrive at the maximum frame size accepted by DKINIT, find the prime number that is closest to, but still less than, the maximum number listed here.

A typical dialogue follows. The one possible error message is this:

ILLEGAL FRAME SIZE

To recover, specify a number between the minimum and maximum.

COMMAND? FRAME <CR>

COMMAND DESTROYS ANY PREVIOUS

RDOS DISK STRUCTURE.

RDOS INIT/F MUST BE DONE

ON DISK AFTER COMMAND.

TYPE CONTROL-A NOW

TO ABORT WITHOUT LOSS

DEFAULT FRAME SIZE IS xx

MIN IS 1, MAX IS yyy

DISK FRAME SIZE

(TYPE RETURN FOR DEFAULT)?

Specify a prime number between 1 and the maximum (represented by yyy), for example, 29; or select the default frame size by typing CR.

COMMAND?

DKINIT is ready to execute another command.

REMAP Command

The REMAP command instructs DKINIT to reserve a specified number of contiguous usable disk blocks for the remap area. It applies to hard disks and double-density diskettes only and is useful when one of the disk blocks within the original remap area is flawed. REMAP effectively destroys any existing file structure because the CLI command INIT/F is always issued afterward.

The REMAP command allows you to declare any number of bad blocks. It adds that number to the number of flawed blocks already recorded in the bad block table and asks you to specify a remap area size (126 maximum) based on the total. Finally, you are asked to supply the block number (octal) at which this area will start. (A default option is also provided; it locates the remap area among the highest usable blocks on the disk.) Later, when RDOS runs, all flawed disk blocks will be represented in the master allocation directory (MAP.DR) as permanently in use; unable to access

them, the system will address one of the usable blocks in the remap area instead.

The top addresses of a disk, unless needed for user programs, should be reserved for the remap area. If the disk in question is unusually full, you can locate the remap area among the middle range of addresses. This reduces head-positioning time, although it also reduces the number of large contiguous files you can create as a result.

The following dialogue is typical when the REMAP command is used. Table 5.7 shows REMAP error messages.

Error Message	Corrective Action
THERE IS NO CURRENT REMAP AREA <i>RUN FULL INIT TO ESTABLISH ONE</i>	Execute the FULL command on this disk or diskette.
ILLEGAL DISK BLOCK NUMBER	Correctly rekey your entry.
RDOS WILL NOT RUN WITH THIS BLOCK BAD. BLOCK NOT ACCEPTED	If in fact this block is bad, use the DTOS hardware formatter to reformat disk. (RDOS cannot run if blocks 0 through 6 are unusable.)
BAD BLOCK LIST IS FULL. UNABLE TO ENTER ANY MORE BAD BLOCKS	Execute the REMAP function again, this time enlarging the remap area size.
NO ROOM FOR BAD BLOCK REMAP AREA DUE TO TOO MANY BAD BLOCKS—ABORTING	Reformat the disk with DTOS and reinitialize it with the FULL command; then try again.
ILLEGAL REMAP AREA START BLOCK NUMBER	Choose another starting block number.
BAD BLOCK CONTAINED IN REMAP AREA <i>SPECIFIED. PLEASE SPECIFY ANOTHER AREA</i>	Choose another area with contiguous, usable blocks.

Table 5.7 Error messages from REMAP command

COMMAND? REMAP (CR)

COMMAND DESTROYS ANY PREVIOUS

RDOS DISK STRUCTURE.

RDOS INIT/F MUST BE DONE

ON DISK AFTER COMMAND.

TYPE CONTROL-A NOW

TO ABORT WITHOUT LOSS

DO YOU WISH TO DECLARE ANY BLOCKS BAD

THAT ARE NOT ALREADY IN THE BAD BLOCK TABLE?

Answer YES to report any bad blocks discovered since full initialization by DTOS (the hardware formatter) or during system use. (DKINIT next asks for the remap area size if you answer NO.)

BAD BLOCK NUMBER (TYPE RETURN TO STOP)

Enter the logical number, in octal, of the bad block you want to declare, for example, 11343. Or enter the head, sector, and cylinder locations and separate them with commas.

BAD BLOCK ENTERED

BAD BLOCK NUMBER (TYPE RETURN TO STOP)

DKINIT returns to this question after each bad block is declared. Once all flawed blocks have been reported, type CR to exit from the loop.

DO YOU WISH TO DECLARE ANY MORE BLOCKS BAD? NO (CR)

DEFAULT REMAP AREA IS xx BLOCKS LONG

IT NEEDS TO BE AT LEAST yy BLOCKS LONG

The default answer is recommended where yy is a number less than xx. Otherwise, specify a decimal number slightly greater than yy (but not more than 126).

REMAP AREA START BLOCK NUMBER

(TYPE RETURN FOR DEFAULT)?

Specify the default answer to locate the remap area among the highest addresses on the disk. Or define an area elsewhere on the disk, making sure that it contains at least one usable disk block for every flawed one, and enter the starting block number in octal. (Table 5.6, shown earlier, lists the highest block number on each RDOS-supported disk as a point of reference.)

COMMAND?

ENTER Command

The ENTER command instructs DKINIT to record all bad blocks reported by the user in the bad block table. The command does not disturb the existing file structure or require that INIT/F be issued afterward. However, should user

entries cause the bad block table to overflow, the REMAP or FULL functions must be executed to enlarge the table.

A typical dialogue follows. Table 5.8 shows the error messages returned by the ENTER command.

Error Message	Corrective Action
ILLEGAL DISK BLOCK NUMBER	Correctly rekey your entry.
RDOS WILL NOT RUN WITH THIS BLOCK BAD.	If in fact this block is bad, use the DTOS hardware formatter to reformat the disk or diskette. (RDOS cannot run if blocks 0 through 5 are unusable.)
BLOCK NOT ACCEPTED	
BAD BLOCK LIST IS FULL.	Execute the REMAP function to enlarge the remap area size.
UNABLE TO ENTER ANY MORE BAD BLOCKS	
BLOCK IS PART OF BAD BLOCK REMAP AREA.	First, using the REMAP function, choose another remap area with contiguous usable blocks. If error recurs, use DTOS to reformat the disk.
IT CAN ONLY BE DECLARED BAD USING	
FULL INIT OR REMAP	

Table 5.8 Error messages from ENTER command

COMMAND? ENTER (CR)

BAD BLOCK NUMBER (TYPE RETURN TO STOP)

Enter the physical bad block number in octal, for example, 136. Or enter the head, sector, and cylinder locations and separate them with commas.

BAD BLOCK ENTERED

BAD BLOCK NUMBER (TYPE RETURN TO STOP)

DKINIT returns to this question after each bad block is declared. Once all flawed blocks have been reported, type CR to exit from the loop.

DO YOU WISH TO DECLARE ANY MORE BLOCKS BAD? NO (CR)

COMMAND?

DKINIT is ready to execute another command.

STOP Command

The STOP command is used to end a session with DKINIT. It halts the disk initializer and the computer. DKINIT can be restarted in one of three ways.

- Press the rocker switch marked CONTINUE on a computer with automatic program load.
- Type P on the keyboard of a computer with a programmed or virtual console.
- Press the lever marked CONTINUE on a computer with hardware data switches.

Appendix A

RDOS Utilities

This appendix describes the utility programs and source files Data General supplies with each RDOS system. The utilities can be packaged with your release software on one reel of magnetic tape, on two double-density diskettes, or on five to six single-density diskettes.

The following table provides the name and a description of each utility, along with the title and DGC number of its supporting manual, if any. All source files (indicated by the suffix .SR) are in ASCII; to learn more about them, use the CLI command TYPE to display one at your console or the CLI command PRINT (if you have a line printer) to obtain a hard copy.

Filename	Description	Notes (see below)
EDIT.SV	Text editor	1
EDIT.RB	Text editor, relocatable binary file	1
MEDIT.SV	Multiterminal text editor	1
(N)SPEED.SV	Super text editor (NSPEED runs on NOVA computers, SPEED on ECLIPSE computers)	2
(N)SPEED.ER	Super text editor error message text file	2
ASM.SV	Extended assembler	3
XREF.SV	Extended assembler cross-reference generator	3
MAC.SV	Macroassembler	3
MACXR.SV	Macroassembler cross-reference generator	

Filename	Description	Notes (see below)
LITMACS.SR	Literal macros for the macroassembler	
xRDOS.SR	Operating system identifier source file, where <i>x</i> identifies your version of RDOS (see Table 1.1, Chapter 1)	
NBID.SR	NOVA Basic Instruction Definitions	4
NSID.SR	NOVA Stack Instruction Definitions	4
NEID.SR	ECLIPSE Instruction Definitions	4
NCID.SR	ECLIPSE Commercial Instruction Definitions	4
N4ID.SR	Special NOVA 4 Instruction Definitions	4
NSKID.SR	NOVA Skip Instruction Definitions	4
FPID.SR	NOVA Floating-point Instruction Definitions	4
OSID.SR	Operating System (RDOS) Instruction Definitions	4
NFPID..SR	ECLIPSE Hardware Floating-point Instruction Definitions	4
NFFID.SR	Floating-point Function Instruction Definitions	

Filename	Description	Notes (see below)
PARU.SR	RDOS user parameter definitions	4
PARS.SR	RDOS system parameter definitions	4
ALMSPD.SR	ALM/ULM line specification source file	5
ALMSPD.RB	Assembled version of ALMSPD.SR containing default line characteristics	5
RFPI.RB	Floating-point interpreter, relocatable binary file	6
N3SAC3.RB	When loaded (RLDR) with a user program, causes .SYSTM calls to return the frame pointer (instead of the user stack pointer) in AC3 for NOVA 3 and 4 computers only.	8
LFE.SV	Library file editor	3
SEDIT.SV	Symbolic file editor	7
OEDIT.SV	Octal file editor	7
DSKED.SV	Stand-alone disk editor	7
xIDEB.RB	Interrupts-off debugger, where <i>x</i> represents your version of RDOS; see Table 1.1, Chapter 1	7
ENPAT.SV	Patch file creation program	7
PATCH.SV	Patch installation program	7
RLDR.SV	Extended relocatable loader program file	3
RLDR.OL	Relocatable loader overlay file	3
OVLDR.SV	Overlay replacement loader	3

Filename	Description	Notes (see below)
SYSGEN.SV	RDOS system generation program	4
SYS.LB	System library, containing tasking code, buffered I/O package, and debugger	3,7
SYS5.LB	An earlier version of SYS.LB (before RDOS rev. 6.00)	8
MATH.LB	Several math routines, such as square root, for assembly language	
VFU.SV	Vertical format control program for data channel line printers	10
DKINIT.SV	Disk initializer	4
FBOOTSYS.SV		4
FBOOTSYS.OL		4
MCABOOT.SV	Multiprocessor communications adapter bootstrap program	8
BOOT.SV	Bootstrap and root installer program	4
FBOOT.SV	Diskette bootstrap loader program	4
TBOOT.SV	Tape bootstrap loader program	4
CBOOT.SV	Cassette bootstrap loader program	
FDUMP.SV	Fast disk dump program	9
FLOAD.SV	Fast disk load program	9
FLOAD.SV	Fast disk load program	9

Filename	Description	Notes (see below)
DLOAD.SV	Moves previously dumped files from diskette to hard disk	
DLOAD.OL	Overlay file for DLOAD.SV	
DDUMP.SV	On-line disk-to-diskette restore utility	9
DDUMP.OL	Overlay file for DDUMP.SV	
DDUMP.ER	Error file for DDUMP.SV	
BURST.SV	NOVA/ECLIPSE off-line disk-to-tape back-up/restore utility	9
TBURST.SV	Microproducts disk-to-tape back-up/restore utility	9
DBURST.SV	NOVA/ECLIPSE system disk-to-diskette back-up/restore utility	9
MBURST.SV	Microproducts system disk-to-diskette back-up/restore utility	9
OWNER.SV	Stand-alone utility that determines which file owns a disk block that was lost during a restore operation	9
BATCH.SV	Places jobs in a batch stream, where RDOS schedules them for executing.	11
BATCH.OL	Overlay file for BATCH.SV	
BATCH.ER	Error file for BATCH.SV	
RCLI.SV	Command Line Interpreter for resident RDOS	

Notes

- (1) See *RDOS/DOS Text Editor* (DGC No. 069-400016).
- (2) See *RDOS/DOS Superedit Text Editor* (DGC NO. 069-400017).
- (3) See *RDOS/DOS Assembly Language and Program Utilities* (DGC No. 069-400019).
- (4) Used primarily to build the macroassembler permanent symbol file, MAC.PS.
- (5) Described in this manual.
- (6) See *Floating Point Interpreter User's Manual* (DGC No. 093-000019).
- (7) See *RDOS/DOS Debugging Utilities* (DGC No. 069-400020).
- (8) See *RDOS System Reference* (DGC No. 093-400027).
- (9) See *RDOS/DOS Backup Utilities* (DGC No. 069-400022).
- (10) See *RDOS/DOS Sort/Merge* and *Vertical Format Utilities* (DGC No. 069-400021).
- (11) See *RDOS/DOS Command Line Interpreter* (DGC No. 069-400015).

Exceptional Conditions

This appendix explains how to recover from the common errors and problems that can occur during the system load and generation process. The first section offers some suggestions for handling bootstrapping problems. The second section lists the error messages returned by RDOS, describes the probable cause of each error, and recommends appropriate actions. Errors reported by the disk initializer, DKINIT, are described in Chapter 5.

Bootstrapping Checklist

If nothing happens during a bootstrap attempt, check for one of five problems.

1. The disk should be inserted in the first drive on its controller; if it is not, insert it in drive 0 or 4.
2. Check the READY indicator on the drive; if it is not lit, wait for it to come on.
3. You may have used the wrong device code while program loading; refer to the instructions in the section entitled "Starting Up the System" in Chapter 4.
4. The program or system may have terminated abnormally. Press the LOAD and then the READY switch on a disk drive, or open and close the door of the diskette drive; then consult the section entitled "Handling a System Failure."
5. If the disk lacks a bootstrap root, install one, and use the CLI command MOVE to copy BOOT.SV to the disk.

RDOS Error Messages

! or ?

The computer is in virtual console mode. Type P, followed by a terminator.

??

A read error has occurred on magnetic tape or cassette. Try again.

CHECKSUM ERROR IN SYSTEM OVERLAY FILE

The file SYS.OL contains an inconsistency. (The same message could apply to overlays for utilities or user programs.) Reload the overlay file. If the error persists, a new overlay file is needed.

DEVICE IMPROPERLY SELECTED

A tape or cassette unit has not been loaded or is not on line. Rethread the tape with the unit off line. Press the LOAD or BOT switch. Then place the unit on line.

DEVICE OFF LINE—UNIT n

The device you specified is not on line or does not exist. Place the device on line or correct its unit name in your command line.

DEVICE TIMEOUT—xxx

The device you specified is not on line or does not exist. Place the device on line or correct its unit name in your command line.

DISK ERROR—STATUS xxx

The disk contains a format error. Consult the appropriate disk hardware manual (014- series) for recovery procedures.

DISK FORMAT ERROR

RDOS cannot access the disk. Bootstrap DKINIT, the initializer, and execute its FULL command, as explained in Chapter 4. Then issue the CLI command INIT/F followed by the unit name of the disk.

FATAL ERROR—unit STATUS =xxxxxx

A tape or cassette unit has a hardware problem. Consult the appropriate Peripherals manual.

FILE ALREADY EXISTS

The CLI displays this message when you attempt to move a file from one directory to another containing a file with the same name. Usually the problem arises when a link entry in the destination directory was not deleted. Enter the destination directory and issue the command line UNLINK.-

<CR>

FILE DATA ERROR

RDOS cannot access the file or disk. Fully initialize the disk with the DKINIT function FULL. Then issue the CLI command INIT/F followed by the unit name of this disk.

If the file in question is SYS.DR, type INIT/F to the disk.

Note that this message also occurs if you attempt to initialize a write-protected diskette.

FILE DOES NOT EXIST

RDOS cannot find the file you specified on this device or does not recognize the device. The directory specifier (for example, DE1: or DP0:) you entered may be incorrect. If so, rekey your entry. If not, make sure that the file in question was moved to this device. If the device itself is in question, generate a new RDOS system that supports it.

FILE NOT EXECUTABLE

The file is not an executable program, or save (.SV), file. Use correct file in command.

FILE NOT FOUND

BOOT cannot find the file you specified on this device. Check the directory specifier (for example, DE1: or DP0:) and filename and correct your entry accordingly.

HARDWARE FAILURE

Run the disk and CPU reliability tests to determine the nature of the problem.

ILLEGAL FILENAME

The command line contains an illegal character. Rekey the command line.

INSUFFICIENT MEMORY FOR SYSTEM OPERATION—SYSGEN ERROR

The computer does not have enough memory to execute this system or program. Bootstrap the starter system and generate a new RDOS system with less memory.

INSUFFICIENT MEMORY TO LOAD PROGRAM

The computer does not have enough memory to load this system or program. Bootstrap the starter system and generate a new RDOS system with less memory.

MASTER DEVICE DRIVER NOT LOADED—SYSGEN ERROR

This RDOS system does not support a controller for the device from which you have tried to bootstrap. Indicate whether this controller is primary or secondary. (It is usually primary). Bootstrap the starter system and generate a new RDOS system that incorporates the controller for the device in question.

NO SUCH DIRECTORY

RDOS does not recognize the disk you specified. Check the directory specifier (for example, DE1: or DP1:), or unit name and correct your command line.

OVERLAY FILE VACUOUS

The disk contains no overlay file for this system. Load the overlay.

PARTITION IN USE. TYPE C TO CONTINUE.

The system was not released in an orderly manner. Type C to continue. Set the parameters of date and time. Then issue the command CLEAR/A/V/D. In most cases, no further problems will occur. If the system fails, however, or some directories or files have disappeared, follow the instructions described in the section entitled "Handling a System Failure" in Chapter 4.

\$PTR DRIVER NOT LOADED. SYSGEN ERROR.

This RDOS system does not include support for the paper tape reader. Bootstrap the starter system, invoke SYSGEN, and reconfigure the system to include \$PTR and \$PTP.

UNKNOWN DEVICE SPECIFIER

The current program does not recognize the device name you have specified. Enter the correct device name.

WARNING: MASTER DEVICE MAP.DR IS ERRONEOUS

RDOS found inconsistencies in MAP.DR, the disk block allocation file. Bootstrap RDOS on another disk. Then issue the CLI command INIT/F followed by the unit name of this disk.

Appendix C

ASCII Character Set

DECIMAL	OCTAL	HEX	KEY SYMBOL	MNEMONIC
0	000	00	↑@	NUL
1	001	01	↑A	SOH
2	002	02	↑B	STX
3	003	03	↑C	ETX
4	004	04	↑D	EOT
5	005	05	↑E	ENO
6	006	06	↑F	ACK
7	007	07	↑G	BEL
8	010	08	↑H	BS (BACKSPACE)
9	011	09	↑I	TAB
10	012	0A	↑J	NEW LINE
11	013	0B	↑K	VT (VERT. TAB)
12	014	0C	↑L	FORM FEED
13	015	0D	↑M	CARRIAGE RETURN
14	016	0E	↑N	SO
15	017	0F	↑O	SI
16	020	10	↑P	DLE
17	021	11	↑Q	DC1
18	022	12	↑R	DC2
19	023	13	↑S	DC3
20	024	14	↑T	DC4
21	025	15	↑U	NAK
22	026	16	↑V	SYN
23	027	17	↑W	ETB
24	030	18	↑X	CAN
25	031	19	↑Y	EM
26	032	1A	↑Z	SUB
27	033	1B	ESC	ESCAPE
28	034	1C	↑\	FS
29	035	1D	↑]	GS
30	036	1E	↑↑	RS
31	037	1F	↑—	US

DECIMAL	OCTAL	HEX	KEY SYMBOL
32	040	20	SPACE
33	041	21	!
34	042	22	" (QUOTE)
35	043	23	#
36	044	24	\$
37	045	25	%
38	046	26	&
39	047	27	' (APOS)
40	050	28	(
41	051	29)
42	052	2A	*
43	053	2B	+
44	054	2C	, (COMMA)
45	055	2D	-
46	056	2E	. (PERIOD)
47	057	2F	/
48	060	30	0
49	061	31	1
50	062	32	2
51	063	33	3
52	064	34	4
53	065	35	5
54	066	36	6
55	067	37	7
56	070	38	8
57	071	39	9
58	072	3A	:
59	073	3B	;
60	074	3C	<
61	075	3D	=
62	076	3E	>
63	077	3F	?
64	100	40	@

DECIMAL	OCTAL	HEX	KEY SYMBOL
65	101	41	A
66	102	42	B
67	103	43	C
68	104	44	D
69	105	45	E
70	106	46	F
71	107	47	G
72	110	48	H
73	111	49	I
74	112	4A	J
75	113	4B	K
76	114	4C	L
77	115	4D	M
78	116	4E	N
79	117	4F	O
80	120	50	P
81	121	51	Q
82	122	52	R
83	123	53	S
84	124	54	T
85	125	55	U
86	126	56	V
87	127	57	W
88	130	58	X
89	131	59	Y
90	132	5A	Z
91	133	5B	[
92	134	5C	\
93	135	5D]
94	136	5E	↑ ^{OR} ^
95	137	5F	← ^{OR} _
96	140	60	~ (GRAVE)

DECIMAL	OCTAL	HEX	KEY SYMBOL
97	141	61	a
98	142	62	b
99	143	63	c
100	144	64	d
101	145	65	e
102	146	66	f
103	147	67	g
104	150	68	h
105	151	69	i
106	152	6A	j
107	153	6B	k
108	154	6C	l
109	155	6D	m
110	156	6E	n
111	157	6F	o
112	160	70	p
113	161	71	q
114	162	72	r
115	163	73	s
116	164	74	t
117	165	75	u
118	166	76	v
119	167	77	w
120	170	78	x
121	171	79	y
122	172	7A	z
123	173	7B	{
124	174	7C	
125	175	7D	}
126	176	7E	~ (TILDE)
127	177	7F	DEL (RUBOUT)

Index

A

Abnormal termination, *see* System failure
Accessing other disks 62-64
ALM, *see* Asynchronous line multiplexor
ALMSPD 51
Alpha lock key (Tables 1.8-9) 23
APL, *see* Automatic program load
Array processors 44
Asynchronous data multiplexor (QTY) 50, 51, 52-53
Asynchronous line multiplexor (ALM) 51, 52
ASCII character codes (Appendix C) 52, 87
Auto restart 49
Automatic program load (APL) 9-10, 25, 26, 59, 60

B

Backup
 on diskette 64-66
 on magnetic tape 66-67
Bad block accounting 71
Bad block pool 47
Bad block testing 71
BMC, *see* Burst multiplexor channel
BOOT (diskette bootstrap), *see* System loading
BOOT command (CLI) 60, 61
Bootstrap root
 definition 2
 installing 30-31, 62, 65
Bootstrap routine 2, 30
Bootstrapping
 definition 1
 from the CLI 60-61
Break key (Table 1.9) 23
Buffers 48
Burst multiplexor channel (BMC) 44
BURST utility 64

C

Card readers (CDR) 50
Carriage return key (CR) (Table 1.8) 23
Cassette tape units (CTA) 50 CDR, *see* Card readers (CDR)
Cells 48

Channels

 background 44
 foreground 44-45
CLI commands
 BOOT 60, 61
 DIR 61, 65
 DUMP 64, 66
 INIT 32, 33, 62, 65, 66
 INIT/F 32, 62, 65, 72, 73, 76, 77
 LINK 63
 LIST 76
 LOAD 32, 33, 34, 64
 LOG 32, 33, 34
 MOVE 32, 62, 65
 RELEASE 32, 54, 61
 TUOFF 67
 TUON 67
 CLI.CM 53
Closing down the system 54, 61-62
Command line interpreter (CLI), *see* CLI commands
Commands
 CLI, *see* CLI commands
 DKINIT, *see* Disk initializer
 virtual console, *see* Virtual console
Computer front panels (Figure 1.3) 10
Controllers 16
Conventions, typesetting ii
Core dump 52-53
Control characters (Table 1.8) 22, 23, 43, 73
Console aids (Tables 1.8-9) 22-23
CR, *see* Carriage return key (CR)
CTA, *see* Cassette tape units (CTA)
CTRL-A (Table 1.8) 22, 43, 73
CTRL-Q (Table 1.8) 23
CTRL-S (Table 1.8) 23

D

Data switches 9-10, 26, 27, 59, 60
DEL key (Tables 1.8-9) 23, 43
Device codes, *see also* Disk drives
 definition 17
 for RTC 49
 for PTR 49
 for PTP 49

for LPT 50
for CDR 50
for PLT 50
for MCA 50
for ALM 51
for QTY 50
for ULM 50
for TTY 52
for MTA 49
for CTA 49

Devices, user-defined 53
Device combinations (Tables 1.4-5) 14-17
Device identifiers (Tables 1.6-7) 17-19
DIR command (CLI) 61, 65
DISK command (DKINIT) 29, 76
Disk drives, *see also* Device identifiers
configurations, *see* Device combinations
model numbers (Table 2.3) 28
operation (Figures 1.9-11) 20-22
storage capacities (Table 2.3) 28
types (Figures 1.4-8) 11-14
unit names (Table 2.3) 28
unit-select features 11, 12, 13, 17, 20, 21
Disk identification 71
Disk initializer (DKINIT)
(Chapter 5),
see also System loading 71-79
overview 71-72
commands (Table 5.1) 72, 73-79
test patterns (Table 5.3) 73, 74
error messages (Tables 5.2, 5.4-5, 5.7-8)
73, 74, 75, 78, 79
sample dialogues 74-75, 76, 77, 78, 79
DKINIT, *see* Disk initializer
Dual processors (IPB) 47
DUMP command (CLI) 64, 66

E

ENPAT utility 68, 69
ENTER command (DKINIT) 78-79
Error messages, *see* Exceptional conditions
Exceptional conditions
from DKINIT (Tables 5.2, 5.4-5, 5.7-8)
73, 74, 75, 78, 79
from system (Appendix B) 85-86
while bootstrapping 85

F

FRAME command (DKINIT) 76-77
FULL command (DKINIT) 28, 73-75
FDUMP utility 64
FLOAD utility 64
Frame size (Table 5.6) 29, 76, 77
Formatting, *see* Initialization
Function keys, *see also* Console aids 22

H

Hardware
identifying 8-19
preparing 19-22
requirements 8, 25

I

INIT command (CLI) 32, 33, 62, 65, 66
INIT/F command (CLI) 32, 62, 65, 72, 73, 76, 77
Initialization
definition 2
full 28, 73-75
partial 75
with INIT, *see* INIT command (CLI)
with INIT/F, *see* INIT/F command (CLI)
IPB, *see* Dual processors
Installing
definition 2
the bootstrap root 30-31, 62, 65
the starter system 31-32

L

Libraries, *see* System libraries
LINK command (CLI) 63
Link entries 63-64
LIST command (DKINIT) 76
LOAD command (CLI) 32, 33, 34, 64
Load map file 42, 43, 68
Loader program, *see also* System loading
definition 1
Log file (LOG.CM) 32, 33, 34
LOG.CM, *see* log file
LPT, *see* Line printer (LPT)

M

Maintenance, *see* System maintenance
Magnetic tape drives (MTA)
operation 19
tailoring 49
MAP.DR, *see* Master allocation directory (MAP.DR)
Master allocation directory (MAP.DR) 61, 71, 72
Master disk
definition 2
MCA, *see* Multiprocessor communications adapter
Memory
required by system features (Table 3.1) 41-42
Model numbers (Tables 1.6-7, 2.3) 18-19, 28
Modems 51
MOVE command (CLI) 32, 62, 65
MTA, *see* Magnetic tape drives (MTA)
Multiplexors 50-51, 52
Multiprocessor communications adapter (MCA) 50

N

New line key (Table 1.8) 23
NOVA and ECLIPSE computers 9-10
NOVA, ECLIPSE, and Microproducts devices 11-19

O

Operator messages 49
Organization of this book i, 24

P

Paper tape punch (PTP) 49
Paper tape reader (PTR) 49
PARTIAL command (DKINIT) 75
Partial initialization 75
PATCH utility 68, 69
Patches
 definition 68
 installing 68-69
Power fail, *see* Auto restart
Power supply 17
Printers, *see* Line printers
Primary unit 17
Program loading
 definition 1
 with virtual console (Tables 2.1, 4.1)
 25-26, 59,60
 with APL 26, 59,60
 with data switches 26-27, 59, 60
 with data switches and APL (Tables 2.2, 4.1)
 26, 59, 60
 troubleshooting 27

Q

QTY, *see* Asynchronous data multiplexor (QTY)

R

Real-time clock (RTC) 49
RDOS
 description 1
 requisite hardware 8, 25
 sample installation (Figure 1.2) 8
 system software (Tables 1.2-3) 4-5
 types (Table 1.1) 3
 utilities (Appendix A) 81-83
Related manuals i-ii
RELEASE command (CLI),
see also Closing down the system 32, 61
see also System software
 definition 2
Remap area 29, 74, 77-78
REMAP command (DKINIT) 77-78
Rubout key (Tables 1.8-9) 23, 43

S

Sample dialogues
 with DKINIT 74-75, 76, 77, 78, 79
 with SYSGEN (Figures 3.1-5) 55-58
 with system software (Figures 2.1-2) 36-37

Secondary console 52
Secondary partitions 48-49
Secondary unit 17
Software parameters 47-49
Stacks (Table 3.3) 47, 48
Starter system
 definition 2
 installing from diskette 32
 installing from tape 31
Starting the system 59-61
STOP command (DKINIT) 29, 79
Subdirectories 48-49
SYS.DR, *see* System directory (SYS.DR)
SYSGEN, *see* System generation and Tailoring
SYS.LM, *see* Load map file
System directory (SYS.DR) 61, 71, 72, 76
System failure 61-62
System generation (Chapter 3), *see also* Tailoring
 associated files 43
 closing procedures 53
 during tuning 67-68
 guidelines 39-43
 invoking SYSGEN 43
 questions and answers 43-53
 sample dialogues (Figures 3.1-5) 55-58
 testing procedures 53-54
System libraries (Tables 1.2-3) 4,5
System loading (Chapter 2) 25-37
 requisite hardware 25
 initiating a loader program 25-27
 initializing your master disk (Table 2.3) 27-29
 installing the bootstrap root 30-31
 installing the starter system 31-32
 loading the utilities 32-34
 summary of steps (Figure 1.1) 6-7
 sample dialogues (Figures 2.1, 2.2) 36-37
System software
 definition 1
 released on diskette (Table 1.3) 5
 released on tape (Table 1.2) 4

T

Tailoring
 auto restart 49
 background channels 44
 bad block pool 47
 buffers 48
 burst multiplexor channel 44
 card reader 50
 cassette tape drives 49
 cells 48
 core dumps 52
 definition 2
 disk drives 45-47
 dual processors (IPB) 47
 foreground channels 44-45
 line printer 49-50
 magnetic tape drives 49

- mapped systems 44-45
- MCA 50
- memory size (Table 3.1) 41-42, 44, 45
- modems 51
- multiplexors 50-52
- operator messages 49
- patch space 45
- processor type 44
- paper tape punch 49
- paper tape reader 49
- plotter 50
- real-time clock 49
- secondary console 52
- shared data area 44
- stacks (Table 3.3) 47-48
- subdirectories 48
- system overlays 44
- tuning 48
- unmapped systems 45
- user-defined devices 53
- TBOOT (tape bootstrap), *see* System loading
- TEST command (DKINIT) 75
- TTY, *see* Secondary console
- TUOFF command (CLI) 67
- TUON command (CLI) 67
- Tuning

U

- UFDs, *see* User file descriptors (UFDs)
- ULM, *see* Universal line multiplexor (ULM)
- Universal line multiplexor (ULM) 50-51, 51-52
- Unit selection 11, 12, 13, 17, 20, 21
- Unit names (Tables 1.6-7, 2.3) 17-19, 28
- Utilities
 - loading from diskette 33-34
 - loading from tape 32-33
 - descriptions (Appendix A) 81-83

V

- Virtual console
 - commands 23
 - computers with 9-10

Y

- YBURST utility 64

DG OFFICES

NORTH AMERICAN OFFICES

Alabama: Birmingham
Arizona: Phoenix, Tucson
Arkansas: Little Rock
California: Anaheim, El Segundo, Fresno, Los Angeles, Oakland, Palo Alto, Riverside, Sacramento, San Diego, San Francisco, Santa Barbara, Sunnyvale, Van Nuys
Colorado: Colorado Springs, Denver
Connecticut: North Branford, Norwalk
Florida: Ft. Lauderdale, Orlando, Tampa
Georgia: Norcross
Idaho: Boise
Iowa: Bettendorf, Des Moines
Illinois: Arlington Heights, Champaign, Chicago, Peoria, Rockford
Indiana: Indianapolis
Kentucky: Louisville
Louisiana: Baton Rouge, Metairie
Maine: Portland, Westbrook
Maryland: Baltimore
Massachusetts: Cambridge, Framingham, Southboro, Waltham, Wellesley, Westboro, West Springfield, Worcester
Michigan: Grand Rapids, Southfield
Minnesota: Richfield
Missouri: Creve Coeur, Kansas City
Mississippi: Jackson
Montana: Billings
Nebraska: Omaha
Nevada: Reno
New Hampshire: Bedford, Portsmouth
New Jersey: Cherry Hill, Somerset, Wayne
New Mexico: Albuquerque
New York: Buffalo, Lake Success, Latham, Liverpool, Melville, New York City, Rochester, White Plains
North Carolina: Charlotte, Greensboro, Greenville, Raleigh, Research Triangle Park
Ohio: Brooklyn Heights, Cincinnati, Columbus, Dayton
Oklahoma: Oklahoma City, Tulsa
Oregon: Lake Oswego
Pennsylvania: Blue Bell, Lancaster, Philadelphia, Pittsburgh
Rhode Island: Providence
South Carolina: Columbia
Tennessee: Knoxville, Memphis, Nashville
Texas: Austin, Dallas, El Paso, Ft. Worth, Houston, San Antonio
Utah: Salt Lake City
Virginia: McLean, Norfolk, Richmond, Salem
Washington: Bellevue, Richland, Spokane
West Virginia: Charleston
Wisconsin: Brookfield, Grand Chute, Madison

INTERNATIONAL OFFICES

Argentina: Buenos Aires
Australia: Adelaide, Brisbane, Hobart, Melbourne, Newcastle, Perth, Sydney
Austria: Vienna
Belgium: Brussels
Bolivia: La Paz
Brazil: Sao Paulo
Canada: Calgary, Edmonton, Montreal, Ottawa, Quebec, Toronto, Vancouver, Winnipeg
Chile: Santiago
Columbia: Bogota
Costa Rica: San Jose
Denmark: Copenhagen
Ecuador: Quito
Egypt: Cairo
Finland: Helsinki
France: Le Plessis-Robinson, Lille, Lyon, Nantes, Paris, Saint Denis, Strasbourg
Guatemala: Guatemala City
Hong Kong
India: Bombay
Indonesia: Jakarta, Pusat
Ireland: Dublin
Israel: Tel Aviv
Italy: Bologna, Florence, Milan, Padua, Rome, Turin
Japan: Fukuoka, Hiroshima, Nagoya, Osaka, Tokyo, Tsukuba
Jordan: Amman
Korea: Seoul
Kuwait: Kuwait
Lebanon: Beirut
Malaysia: Kuala Lumpur
Mexico: Mexico City, Monterrey
Morocco: Casablanca
The Netherlands: Amsterdam, Rijswijk
New Zealand: Auckland, Wellington
Nicaragua: Managua
Nigeria: Ibadan, Lagos
Norway: Oslo
Paraguay: Asuncion
Peru: Lima
Philippine Islands: Manila
Portugal: Lisbon
Puerto Rico: Hato Rey
Saudi Arabia: Jeddah, Riyadh
Singapore
South Africa: Cape Town, Durban, Johannesburg, Pretoria
Spain: Barcelona, Bilbao, Madrid
Sweden: Gothenburg, Malmo, Stockholm
Switzerland: Lausanne, Zurich
Taiwan: Taipei
Thailand: Bangkok
Turkey: Ankara
United Kingdom: Birmingham, Bristol, Glasgow, Hounslow, London, Manchester
Uruguay: Montevideo
USSR: Espoo
Venezuela: Maracaibo
West Germany: Dusseldorf, Frankfurt, Hamburg, Hannover, Munich, Nuremberg, Stuttgart

Ordering Technical Publications

TIPS is the Technical Information and Publications Service—a new support system for DGC customers that makes ordering technical manuals simple and fast. Simple, because TIPS is a central supplier of literature about DGC products. And fast, because TIPS specializes in handling publications.

TIPS was designed by DG's Educational Services people to follow through on your order as soon as it's received. To offer discounts on bulk orders. To let you choose the method of shipment you prefer. And to deliver within a schedule you can live with.

How to Get in Touch with TIPS

Contact your local DGC education center for brochures, prices, and order forms. Or get in touch with a TIPS administrator directly by calling (617) 366-8911, extension 4086, or writing to

Data General Corporation
Attn: Educational Services, TIPS Administrator
MS F019
4400 Computer Drive
Westborough, MA 01580

TIPS. For the technical manuals you need, when you need them.

DGC Education Centers

Boston Education Center
Route 9
Southboro, Massachusetts 01772
(617) 485-7270

Washington, D.C. Education Center
7927 Jones Branch Drive, Suite 200
McLean, Virginia 22102
(703) 827-9666

Atlanta Education Center
6855 Jimmy Carter Boulevard, Suite 1790
Norcross, Georgia 30071
(404) 448-9224

Los Angeles Education Center
5250 West Century Boulevard
Los Angeles, California 90045
(213) 670-4011

Chicago Education Center
703 West Algonquin Road
Arlington Heights, Illinois 60005
(312) 364-3045



ISD User Documentation Remarks Form

Your Name _____

Your Title _____

Company _____

Street _____

City _____ State _____ Zip _____

We wrote this book for you, and we made certain assumptions about who you are and how you would use it. Your comments will help us correct our assumptions and improve the manual. Please take a few minutes to respond. Thank you.

Manual Title How to Load and Generate RDOS Manual No. 069-400013-00

Who are you?

- EDP Manager Analyst/Programmer
 Senior Systems Analyst Operator
 Other _____

What programming language(s) do you use? _____

How do you use this manual? (List in order: 1 = Primary Use)

- ____ Introduction to the product _____ Tutorial Text
____ Reference _____ Operating Guide
____ Other _____

About the manual:

	Yes	Somewhat	No
Is it easy to read?	<input type="checkbox"/>	<input type="checkbox"/>	<input type="checkbox"/>
Is it easy to understand?	<input type="checkbox"/>	<input type="checkbox"/>	<input type="checkbox"/>
Are the topics logically organized?	<input type="checkbox"/>	<input type="checkbox"/>	<input type="checkbox"/>
Is the technical information accurate?	<input type="checkbox"/>	<input type="checkbox"/>	<input type="checkbox"/>
Can you easily find what you want?	<input type="checkbox"/>	<input type="checkbox"/>	<input type="checkbox"/>
Does it tell you everything you need to know?	<input type="checkbox"/>	<input type="checkbox"/>	<input type="checkbox"/>
Do the illustrations help you?	<input type="checkbox"/>	<input type="checkbox"/>	<input type="checkbox"/>

If you have any comments on the software itself, please contact your Data General Systems Engineer.
If you wish to order manuals, see your Data General Sales Representative.

Remarks:

Date _____

CUT ALONG DOTTED LINE

FOLD

FOLD

TAPE

TAPE

FOLD

FOLD



NO POSTAGE
NECESSARY
IF MAILED
IN THE
UNITED STATES

BUSINESS REPLY MAIL
FIRST CLASS PERMIT NO. 26 SOUTHBORO, MA. 01772

Postage will be paid by addressee:



**User Documentation, M.S. E-111
4400 Computer Drive
Westborough, Massachusetts 01581**

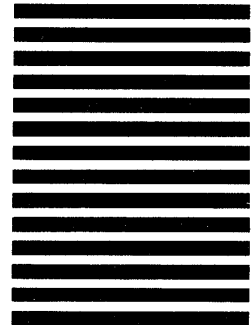

DataGeneral Users group

Installation Membership Form

Name _____ Position _____ Date _____

Company, Organization or School _____

Address _____ City _____ State _____ Zip _____

Telephone: Area Code _____ No. _____ Ext. _____

1. Account Category

- OEM
 End User
 System House
 Government

5. Mode of Operation

- Batch (Central)
 Batch (Via RJE)
 On-Line Interactive

2. Hardware

M/600
 MV/Series ECLIPSE®
 Commercial ECLIPSE
 Scientific ECLIPSE
 Array Processors
 CS Series
 NOVA®4 Family
 Other NOVAs
 microNOVA® Family
 MPT Family

Qty. Installed Qty. On Order

Qty. Installed	Qty. On Order

Other _____
 (Specify) _____

6. Communication

- HASP X.25
 HASP II SAM
 RJE80 CAM
 RCX 70 XODIAC™
 RSTCP DG/SNA
 4025 3270
 Other

Specify _____

7. Application Description

○ _____

3. Software

- AOS RDOS
 AOS/VS DOS
 AOS/RT32 RTOS
 MP/OS Other
 MP/AOS

Specify _____

8. Purchase

From whom was your machine(s) purchased?

- Data General Corp.
 Other
 Specify _____

4. Languages

- ALGOL BASIC
 DG/L Assembler
 COBOL FORTRAN 77
 Interactive FORTRAN 5
 COBOL RPG II
 PASCAL PL/1
 Business APL
 BASIC Other

Specify _____

9. Users Group

Are you interested in joining a special interest or regional Data General Users Group?

○ _____

CUT ALONG DOTTED LINE

 DataGeneral

FOLD

FOLD

TAPE

TAPE

FOLD

FOLD



NO POSTAGE
NECESSARY
IF MAILED
IN THE
UNITED STATES

BUSINESS REPLY MAIL
FIRST CLASS PERMIT NO. 26 SOUTHBORO, MA. 01772

Postage will be paid by addressee:



ATTN: Users Group Coordinator (C-228)
4400 Computer Drive
Westboro, MA 01581

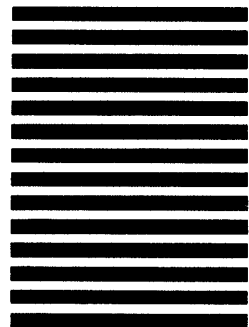

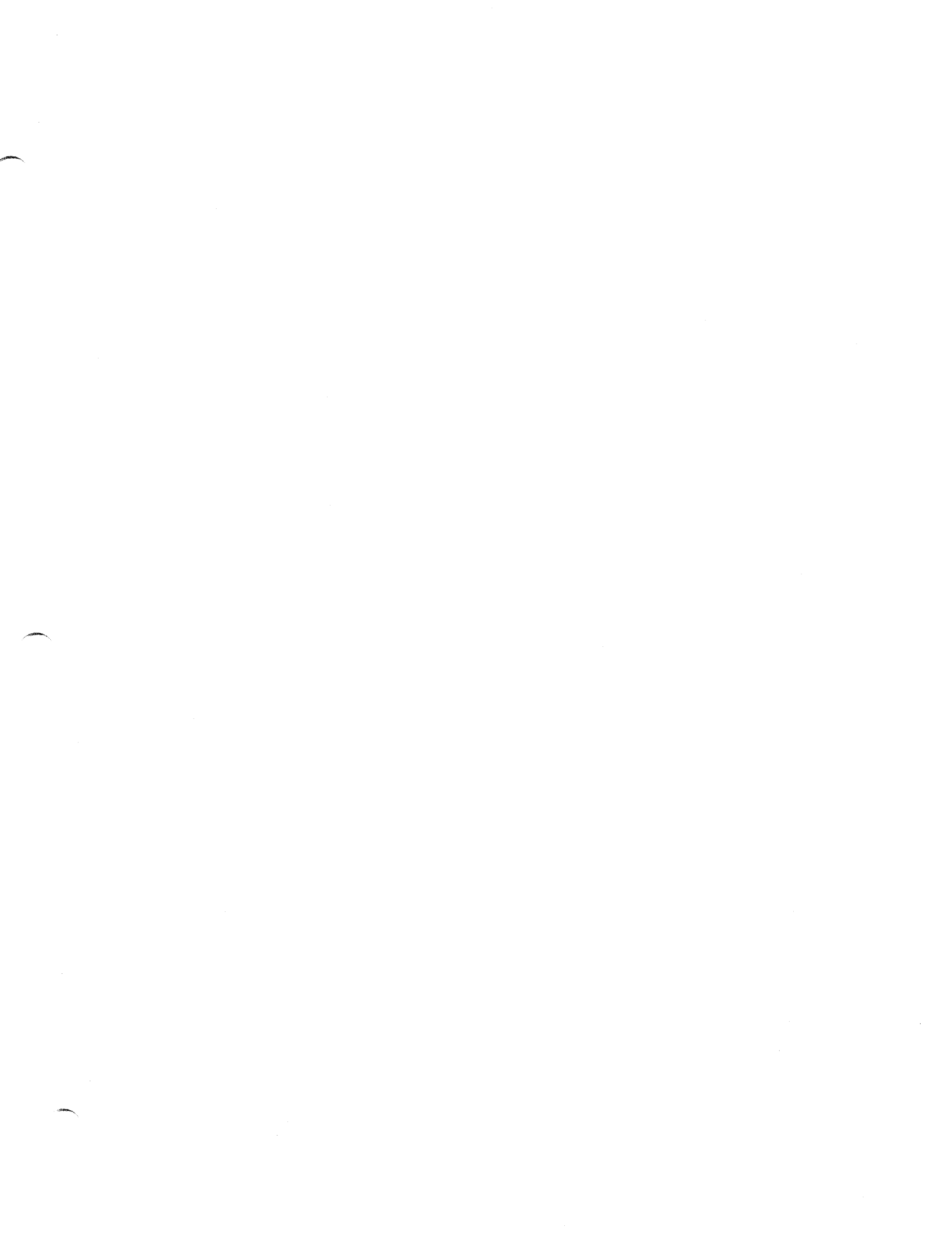







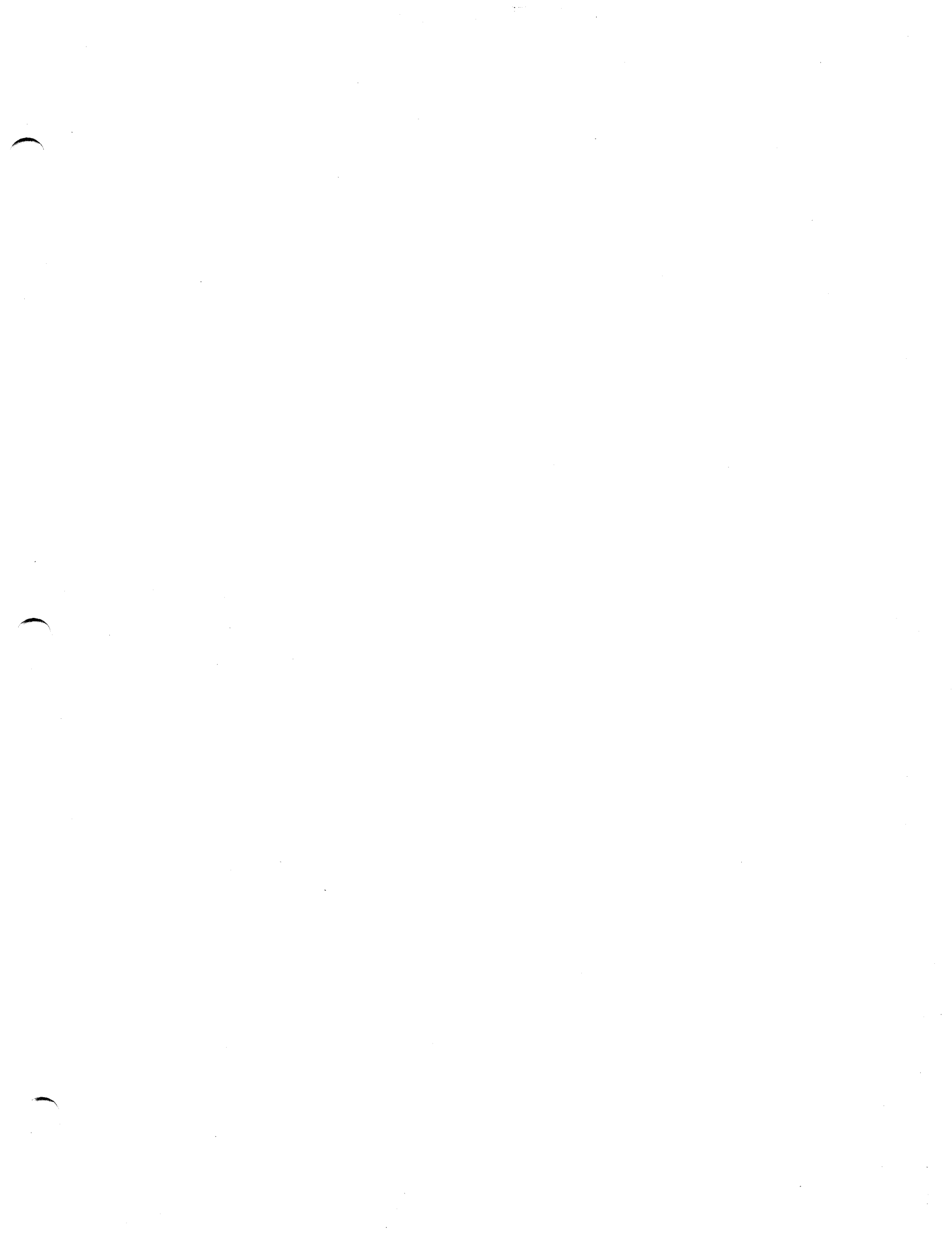

 **Data General**

Data General Corporation, Westboro, Massachusetts 01580

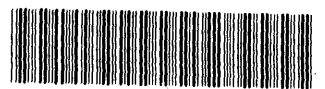

069-400013-00