

 Data General

RDOS USER

**Self-Paced
Instruction Course**



053-000017

REPORT

Self-Paced Instruction Course

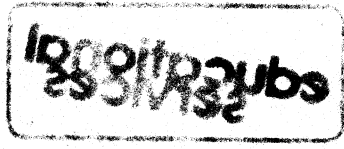

Table of Contents

Module 1	—	Student Orientation
Module 2	—	Introduction and Overview
Module 3	—	Installation of a Student System
Module 4	—	System Start Up and Shut Down
Module 5	—	Command Line Interpreter
Module 6	—	Secondary Storage
Module 7	—	The Supereditor
Module 8	—	Program Development Cycle
Module 9	—	Memory Management
Module 10	—	Dual Programming
Module 11	—	System Generation and Maintenance <i>See manual 093-000188-02</i>
Appendix A	—	Quiz Answers
Appendix B	—	I/O Device Codes
Appendix C	—	ASCII Character Set
Appendix D	—	Modems

Module 1 Introduction

The first module of the course is an introduction to the course. It covers the basic concepts and terminology of the course. The module is designed to provide a solid foundation for the rest of the course. It includes a review of the course objectives and a discussion of the course structure. The module also covers the basic concepts and terminology of the course.

The second module of the course is an introduction to the course. It covers the basic concepts and terminology of the course. The module is designed to provide a solid foundation for the rest of the course. It includes a review of the course objectives and a discussion of the course structure. The module also covers the basic concepts and terminology of the course.

The third module of the course is an introduction to the course. It covers the basic concepts and terminology of the course. The module is designed to provide a solid foundation for the rest of the course. It includes a review of the course objectives and a discussion of the course structure. The module also covers the basic concepts and terminology of the course.

The fourth module of the course is an introduction to the course. It covers the basic concepts and terminology of the course. The module is designed to provide a solid foundation for the rest of the course. It includes a review of the course objectives and a discussion of the course structure. The module also covers the basic concepts and terminology of the course.

The fifth module of the course is an introduction to the course. It covers the basic concepts and terminology of the course. The module is designed to provide a solid foundation for the rest of the course. It includes a review of the course objectives and a discussion of the course structure. The module also covers the basic concepts and terminology of the course.

The sixth module of the course is an introduction to the course. It covers the basic concepts and terminology of the course. The module is designed to provide a solid foundation for the rest of the course. It includes a review of the course objectives and a discussion of the course structure. The module also covers the basic concepts and terminology of the course.

Module 1

Student Orientation

Course Description

This course teaches you how to use Data General's Real Time Disc Operating System (RDOS). You will learn how to install, generate, and maintain an RDOS system that can be tailored to your specific hardware configuration. The course shows you how to manage and communicate with your system by using a program called the Command Line Interpreter (CLI). The course also describes the steps that are required for the development of application programs. In addition, the course provides an introduction to some of the basic characteristics of Data General's NOVA and ECLIPSE computers.

Prerequisites

This course is designed for students who are familiar with data processing concepts and who have previous programming experience. However, students do not have to be familiar with Data General computers.

This course is recommended for System Managers, Data Base Administrators, System Analysts, and Application Programmers.

Course Goals

Upon successful completion of this course you will be able to:

1. Describe capabilities and hardware requirements of RDOS.
2. Start up and shut down an RDOS system.
3. Communicate with RDOS using the Command Line Interpreter.
4. Describe and manipulate RDOS disc and tape structures.

5. Create and edit text with the Supereditor.
6. Given a source program, compile (or assemble), load, and execute the program.
7. Describe programming techniques to manage memory.
8. Describe foreground/background processing.
9. Generate and maintain an RDOS system.

Course Organization

This course is completely self-contained and is arranged in a modular, self-paced format. You can progress through the course at your own pace and in your own setting. The course contains 11 modules each of which covers a specific topic or theme. Most modules consist of two parts:

1. An audiocassette tape
2. A section of text, figures, and exercises contained in this notebook (the Student Guide).

When you are instructed, listen to the audiocassette tape as you follow along in the Student Guide.

At the beginning of each module of the Student Guide, there is a list of Learning Objectives that tell you exactly what you should learn in the module. You can evaluate your performance of these Learning Objectives by completing the exercises and Module Quiz contained in each module. Answers are provided so that you can score your own test to see how well you do. If your score indicates that you have mastered the material, then you may continue with the next module; otherwise, you should restudy the module material before proceeding.

In addition, some modules contain Lab Exercises that allow you to practice the module's Learning Objectives. If you have a computer running RDOS that is available for your own use, then it is recommended that you do the Lab Exercises using the computer. However, this is not required; the Lab Exercises are designed so that you can do them without a computer.

On the next page is a course map (see Figure 1.1). It illustrates the order in which you should progress through the course. As you can see, the modules should be studied consecutively as they appear in the Student Guide, with one exception: Module 3.

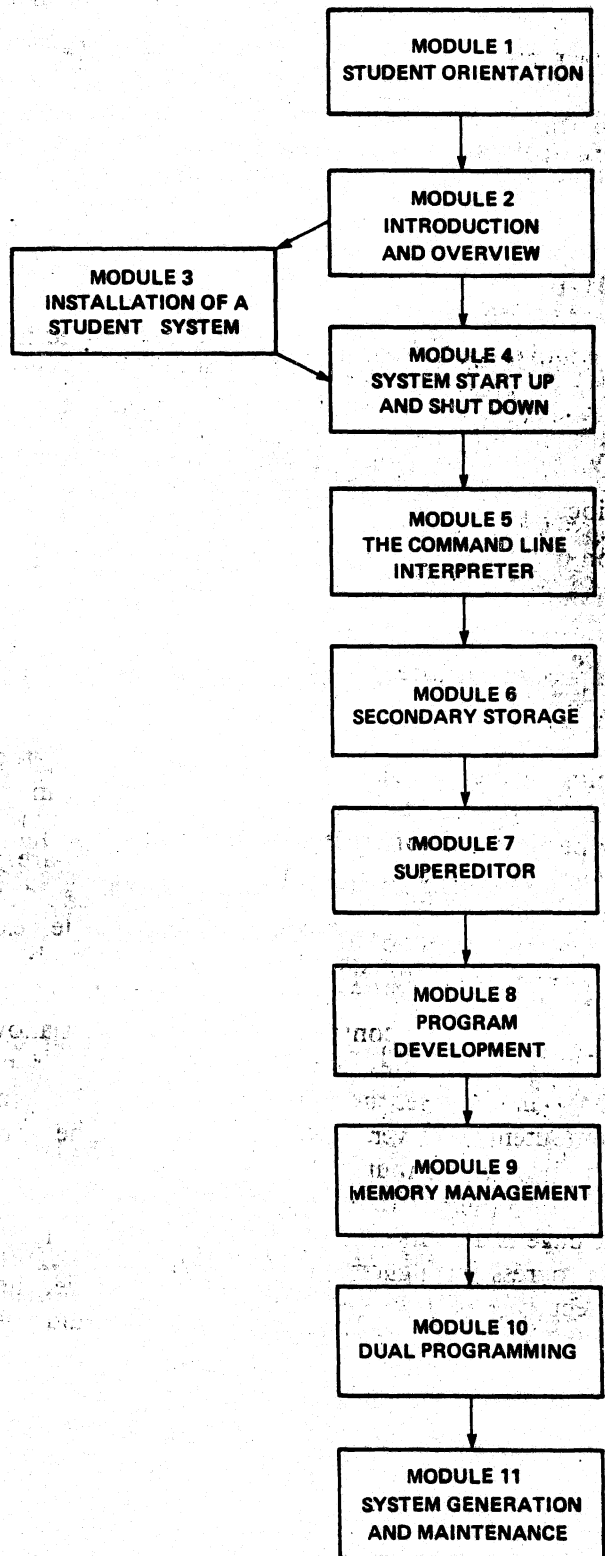

CS-00893

Figure 1.1 Course Map

Module 3 is *optional*; you may omit it if you like. It is for students who wish to install an RDOS system on their own disc, so they may practice the concepts presented in subsequent modules. Module 3 demonstrates how to generate a simple RDOS system that will be suitable for the Lab Exercises presented in this course. It does not attempt to show how to generate RDOS systems suitable for your "real world" applications. (This is covered in Module 11.)

Module 3 is applicable only if you have access to:

1. Your own "scratch disc"
2. A suitable NOVA or ECLIPSE computer
3. RDOS release tapes
4. Certain hardware information relating to your particular configuration. (The specific information needed is listed at the beginning of Module 3.)

Resources

This package is complete in itself. It contains the following:

1. Audiocassette Tapes
2. Student Guide
3. *RDOS/DOS User's Handbook* (093-000105-03)
4. *Magnetic Tape Transports — Operator's Manual* (014-000095-00)
5. *DGC Disc Drives — Operator's Manual* (014-000099-02)

Related Publications

Additional related information can be found in the following Data General publications:

- 017-000003-02 — *Buffered Input/Output Package (NOVA)*
- 017-000020-00 — *Buffered Input/Output Package (ECLIPSE)*
- 069-000002-00 — *Introduction to the Real Time Disc Operating System*
- 069-000022-00 — *Learning to Use Your RDOS/DOS System*
- 093-000002-01 — *Bootstrap Loader User's Manual*
- 093-000003-06 — *Binary Loader User's Manual*
- 093-000018-09 — *Text Editor User's Manual*
- 093-000019-04 — *Floating-Point Interpreter User's Manual*
- 093-000040-01 — *Extended Assembler User's Manual (NOVA)*
- 093-000041-03 — *Relocatable Math Library User's Manual*
- 093-000044-04 — *Symbolic Debugger User's Manual (NOVA)*
- 093-000074-05 — *Library File Editor (LFE) User's Manual*

- 093-000075-08 — *RDOS Reference Manual*
- 093-000080-05 — *Extended Relocatable Loaders User's Manual*
- 093-000081-05 — *RDOS/DOS Macroassembler User's Manual*
- 093-000084-02 — *Octal Editor User's Manual*
- 093-000087-03 — *RDOS Batch User's Manual (NOVA)*
- 093-000105-03 — *RDOS/DOS User's Handbook*
- 093-000109-01 — *RDOS/DOS Command Line Interpreter User's Manual*
- 093-000111-01 — *Superedit Text Editor User's Manual (RDOS/DOS)*
- 093-000133-00 — *RDOS Batch User's Manual (ECLIPSE)*
- 093-000139-00 — *Extended Assembler User's Manual (ECLIPSE)*
- 093-000140-00 — *Symbolic Debugger User's Manual (ECLIPSE)*
- 093-000160-00 — *Symbolic Editor (SEEDIT) User's Manual*
- 093-000186-00 — *DISKEDIT User's Manual (NOVA)*
- 093-000187-00 — *DISKEDIT User's Manual (ECLIPSE)*
- 093-000188-02 — *How to Load and Generate Your RDOS System*
- 093-000231-00 — *User Device Driver Implementation in RDOS*

Command Formats

This course uses the following conventions for command formats:
COMMAND required *[optional]*...

Where **Means**

COMMAND You must enter the command (or its accepted abbreviation) as shown.

required You must enter some argument (such as a filename).
 Sometimes, you use:

{ required₁ }
 { required₂ }

which means you must enter *one* of the arguments. Don't enter the braces; they only set off the choice.

[optional] You have the option of entering this argument. Don't enter the brackets; they only set off what's optional.

. . . You may repeat the preceding entry or entries. The explanation will tell you exactly what you may repeat.

Additionally, certain symbols are used in special ways:

Symbol	Means
}	Press the RETURN key on your terminal's keyboard.
□	Be sure to put a space here. (It is used only when necessary; normally, you can see where to put spaces.)

All numbers are decimal unless indicated otherwise; e.g., 35g (octal).

Finally, examples use:

THIS TYPEFACE TO SHOW YOUR ENTRY }

THIS TYPEFACE FOR SYSTEM QUERIES AND RESPONSES.

Module 2

Introduction and Overview

Introduction

Data General's Real Time Disc Operating System (RDOS) acts as an interface between you and a NOVA or ECLIPSE computer. RDOS allows you to use the hardware without having to know all the details of its operation. However, before you can use RDOS you must have a general understanding of the computer itself. Therefore, the first part of this module is devoted to the basic characteristics of NOVA and ECLIPSE computers. This is followed by a general overview of the features and characteristics of RDOS.

Learning Objectives

Upon successful completion of this module you will be able to:

1. List the three main sections of NOVA and ECLIPSE computers.
2. Differentiate between binary and octal number systems.
3. Describe the memory system of NOVA and ECLIPSE computers by identifying the meaning of the following terms:

Bit
Byte
Word
Page
Address
Read/Write Memory
ROM
Core Memory
Semiconductor Memory
MAP

4. Describe the NOVA and ECLIPSE CPU by identifying the meaning of the following terms:

Control Unit
Arithmetic/Logic Unit
Accumulators
Program Counter
Instruction Register

5. Describe the input/output system of NOVA and ECLIPSE by identifying the meaning of the following terms:

- Primary Controller
- Secondary Controller
- Direct Program Control
- Data Channel Control
- Device Code
- ASCII Code
- Baud Rate
- Multiplexor
- Magnetic Tape Drive
- Disc Drive
- Tracks
- Fixed-Head Disc
- Moving-Head Disc

6. Identify the purpose of the following:

- Power ON/OFF Switch
- Reset/Stop Switch
- Program Load Switch
- Lock Switch
- Data Switches
- Programmed Console

7. Identify the meaning of the following RDOS terms:

- Utilities
- CLI
- R Prompt
- File
- Foreground/Background
- RDOS Flavors
- Product Release Notice
- System Generation
- Tuning

Resources

1. RDOS Student Guide, Module 2
2. Audiocassette tape for Module 2
3. *Magnetic Tape Transports — Operator's Manual*
4. *DGC Disc Drives — Operator's Manual*

Module Outline

1. The Three Sections of NOVA and ECLIPSE Computers
 - a. Memory System
 - b. Central Processing Unit
 - c. Input/Output System
2. Mass Storage Devices
 - a. Magnetic Tape Drives
 - b. Disc Drives
3. Front Panel and Programmed Console Operations
4. RDOS Overview
 - a. Communicating with RDOS
 - b. Files
 - c. Program Development
 - d. Foreground/Background
 - e. Software Release
 - f. System Generation
5. Module Quiz

Directions

Turn to Figure 2.1 and listen to the audiocassette tape for Module 2.

Three Sections of NOVA and ECLIPSE Computers

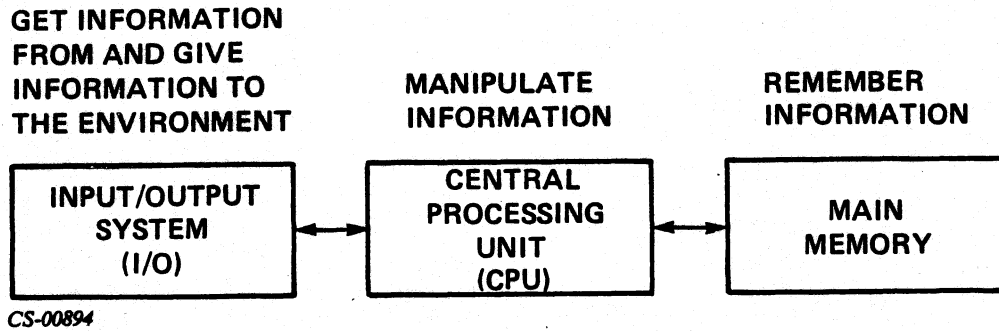
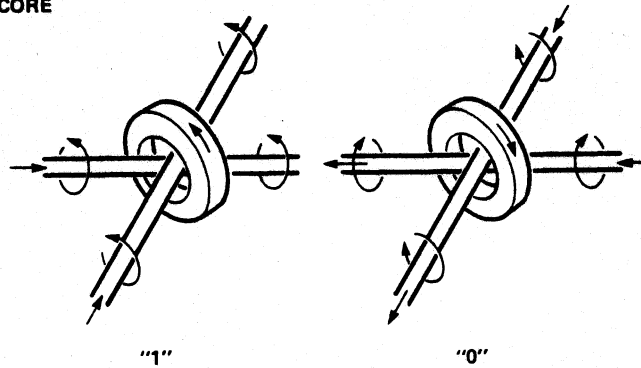

Figure 2.1 The Three Sections of a Computer System

A. MAGNETIC CORE



- RETAINS INFORMATION FOR AN INDEFINITE PERIOD OF TIME

B. SEMICONDUCTOR

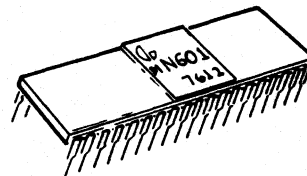

OFF: "0"
ON: "1"

- INFORMATION IS VOLATILE—IT IS LOST WHEN POWER IS REMOVED

CS-00895

Figure 2.2 Two Types of Memory

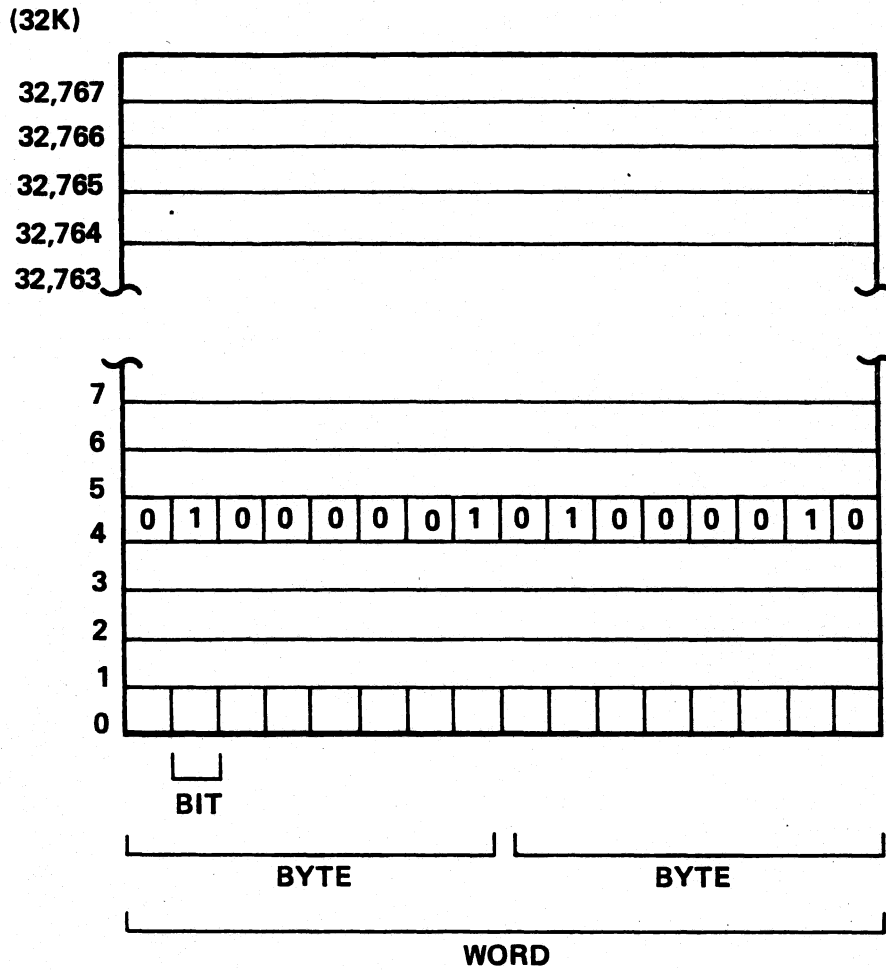

CS-00896

Figure 2.3 Organization of Random Access Memory (RAM)

Table 2.A Number Systems

Number Systems	Digits	Radix (Base)
Binary	01	2
Octal	01234567	8
Decimal	0123456789	10

A THREE DIGIT BINARY NUMBER EQUALS 1 OCTAL DIGIT		BASED ON THE POSITIONAL VALUE OF THE BINARY DIGIT
000	0	$0 \times 2^2 + 0 \times 2^1 + 0 \times 2^0$
001	1	$0 \times 2^2 + 0 \times 2^1 + 1 \times 2^0$
010	2	$0 \times 2^2 + 1 \times 2^1 + 0 \times 2^0$
011	3	$0 \times 2^2 + 1 \times 2^1 + 1 \times 2^0$
100	4	$1 \times 2^2 + 0 \times 2^1 + 0 \times 2^0$
101	5	$1 \times 2^2 + 0 \times 2^1 + 1 \times 2^0$
110	6	$1 \times 2^2 + 1 \times 2^1 + 0 \times 2^0$
111	7	$1 \times 2^2 + 1 \times 2^1 + 1 \times 2^0$

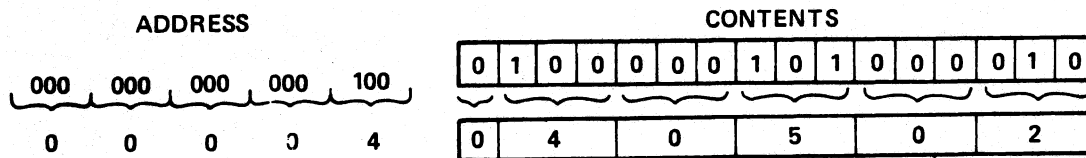

CS-00897

Figure 2.4 Binary to Octal Conversion

Table 2.B Octal to Decimal Conversion

DIGIT POSITION	5	4	3	2	1	0
VALUE	OCTAL DIGIT $\times 8^5$	OCTAL DIGIT $\times 8^4$	OCTAL DIGIT $\times 8^3$	OCTAL DIGIT $\times 8^2$	OCTAL DIGIT $\times 8^1$	OCTAL DIGIT $\times 8^0$
0	0	0	0	0	0	0
1	32,768	4,096	512	64	8	1
2	65,536	8,192	1,024	128	16	2
3	98,304	12,288	1,536	192	24	3
4	131,072	16,384	2,048	256	32	4
5	163,840	20,480	2,560	320	40	5
6	196,608	24,576	3,072	384	48	6
7	229,376	28,672	3,584	448	56	7

OCTAL
DIGIT

- To convert octal to decimal: For each octal digit in a given position, find its decimal equivalent in the table. Add these to obtain the decimal number.

Octal to Decimal Conversion Example

$$40502_8 = (2 \times 8^0) + (0 \times 8^1) + (5 \times 8^2) + (0 \times 8^3) + (4 \times 8^4) = 16,706_{10}$$

$$77777_8 = 7 + 56 + 448 + 3,584 + 28,672 = 32,767_{10}$$

Address Range

An address is represented in 15 bits.

Address Range:

	Lowest	...	Highest
Base 2:	000000000000000	...	111111111111111
Base 8:	0	...	7777
Base 10:	0	...	32,767

Address Space:

32,768 16-bit words (32K words)

UNMAPPED

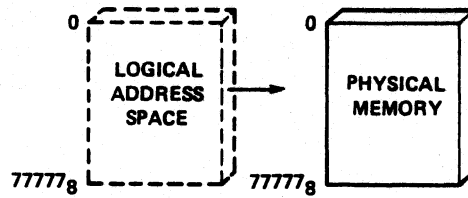

LOGICAL SPACE = PHYSICAL SPACE

MAPPED

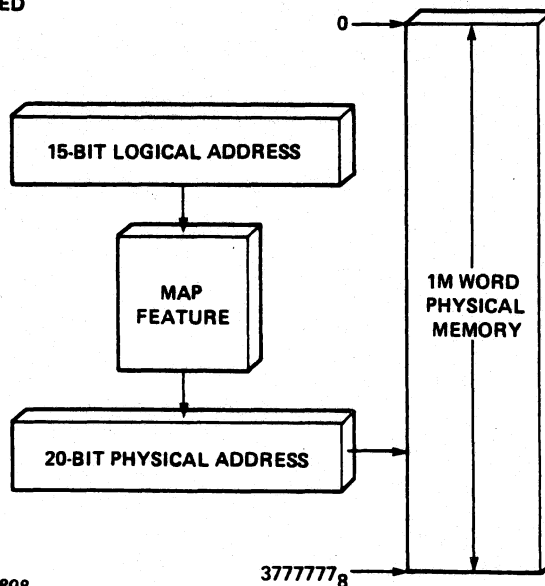

CS-00898

Figure 2.5 Address Space

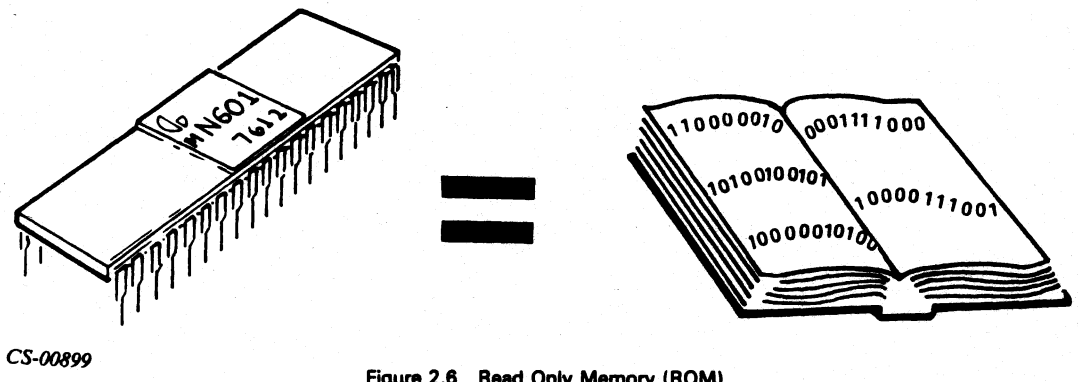

Figure 2.6 Read Only Memory (ROM)

- Read Only Memory = ROM
- Information Placed on Chip When it is Manufactured
- Information Accessible but Unalterable

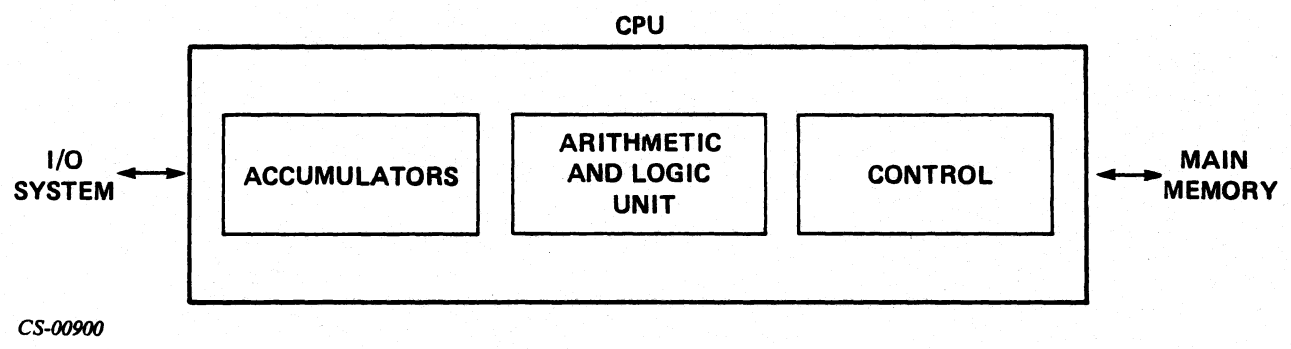
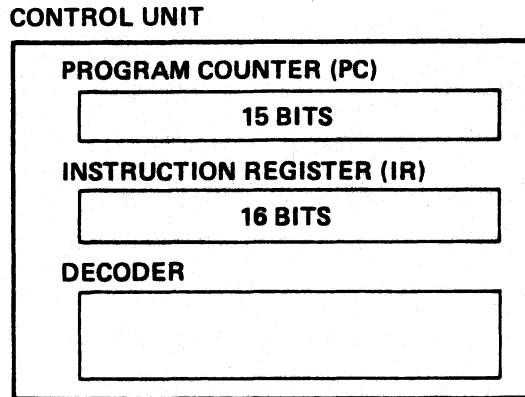

Figure 2.7 The CPU



CS-00901

Figure 2.8 The Control Unit

- PC — Holds the address of the next instruction to be executed
- IR — Holds the instruction
- Decoder — Decodes the instruction

CPU

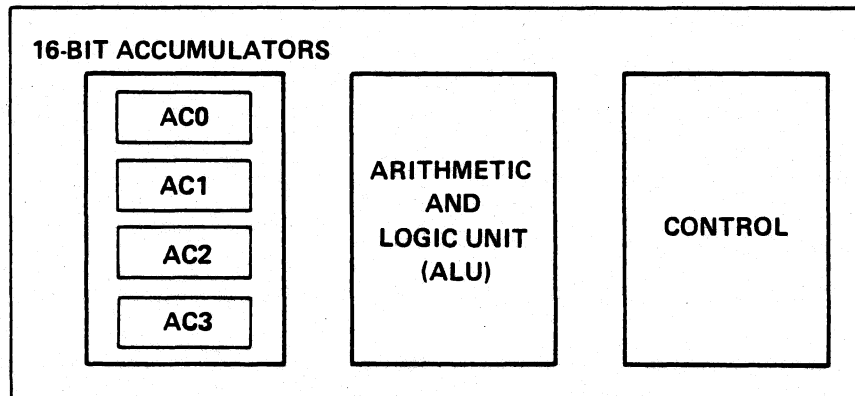

CS-00902

Figure 2.9 Accumulators and the ALU

- ALU — Performs arithmetic and logical operations.
- Accumulators — Internal, easily accessible, limited-storage area for the temporary storage and manipulation of operands.



CS-00903

Figure 2.10 The Three Sections of a Computer System

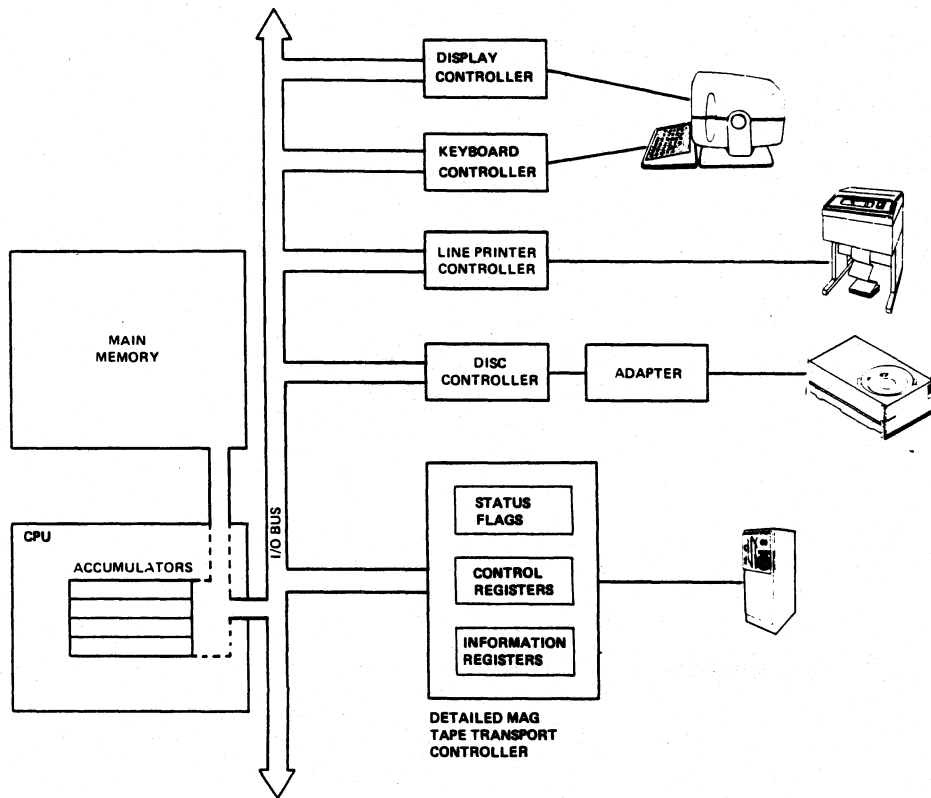

CS-00904

Figure 2.11 The Input/Output Section

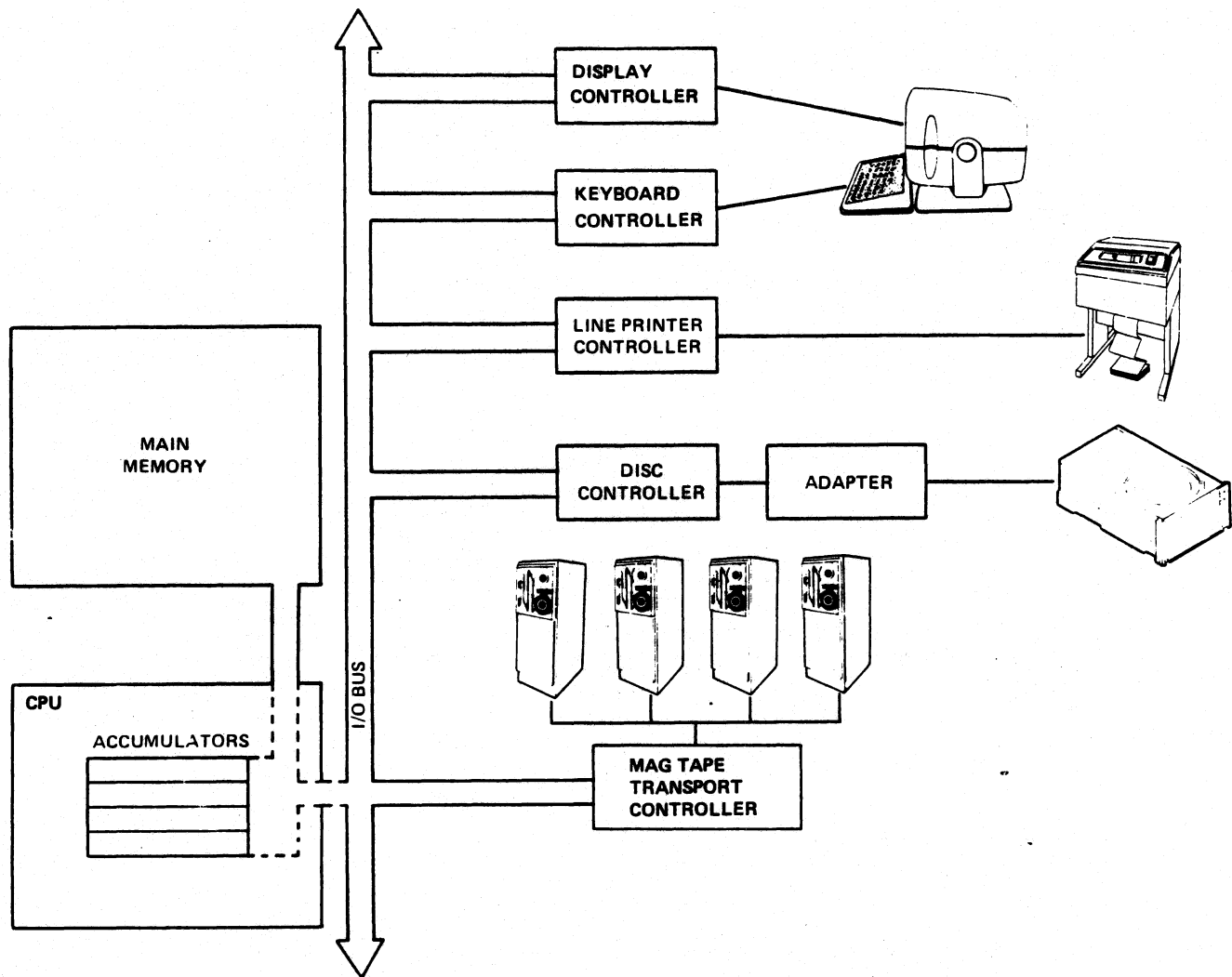

CS-00905

Figure 2.12 Several Devices Connected to a Single Controller

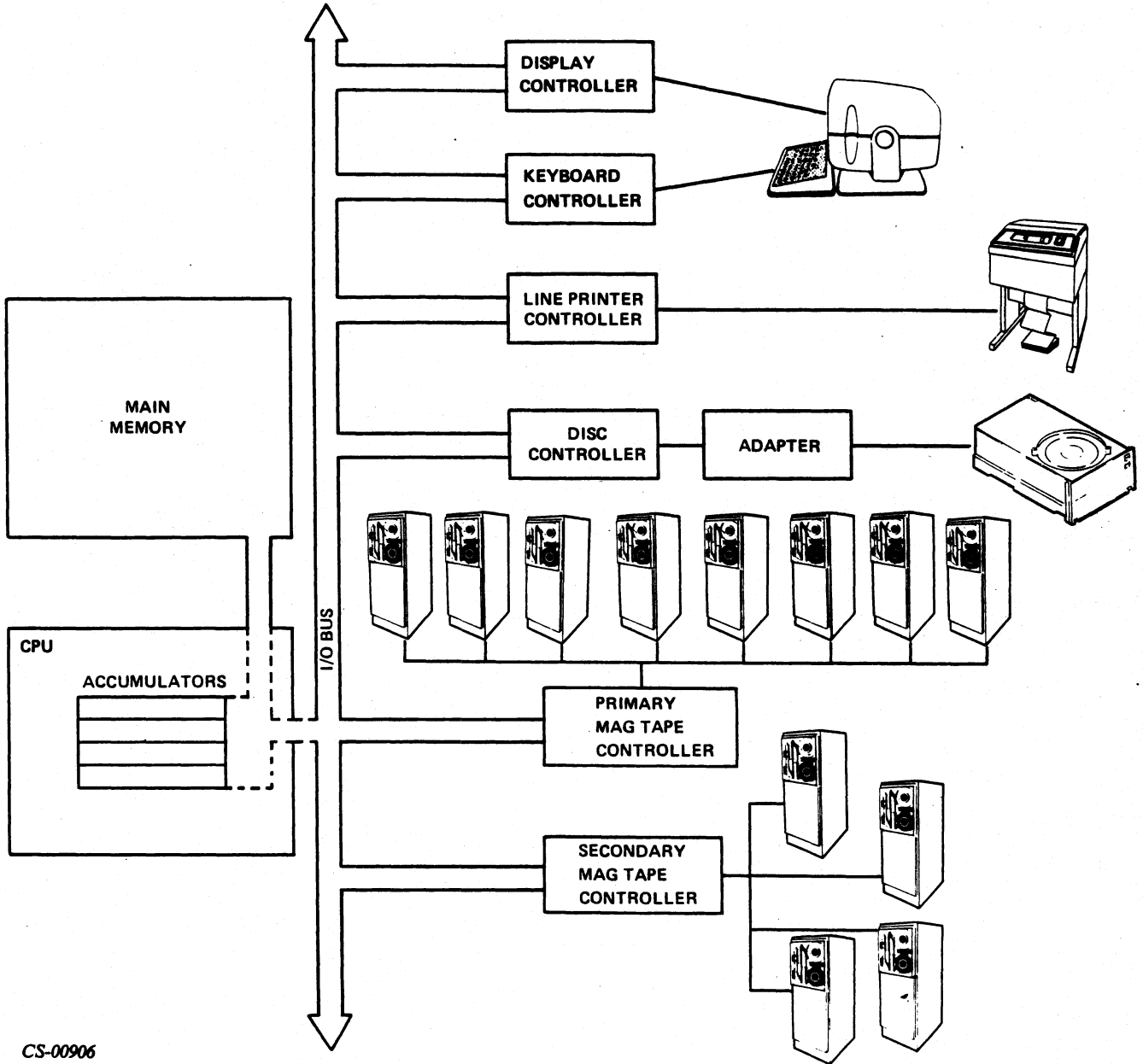

CS-00906

Figure 2.13 Primary and Secondary Controllers

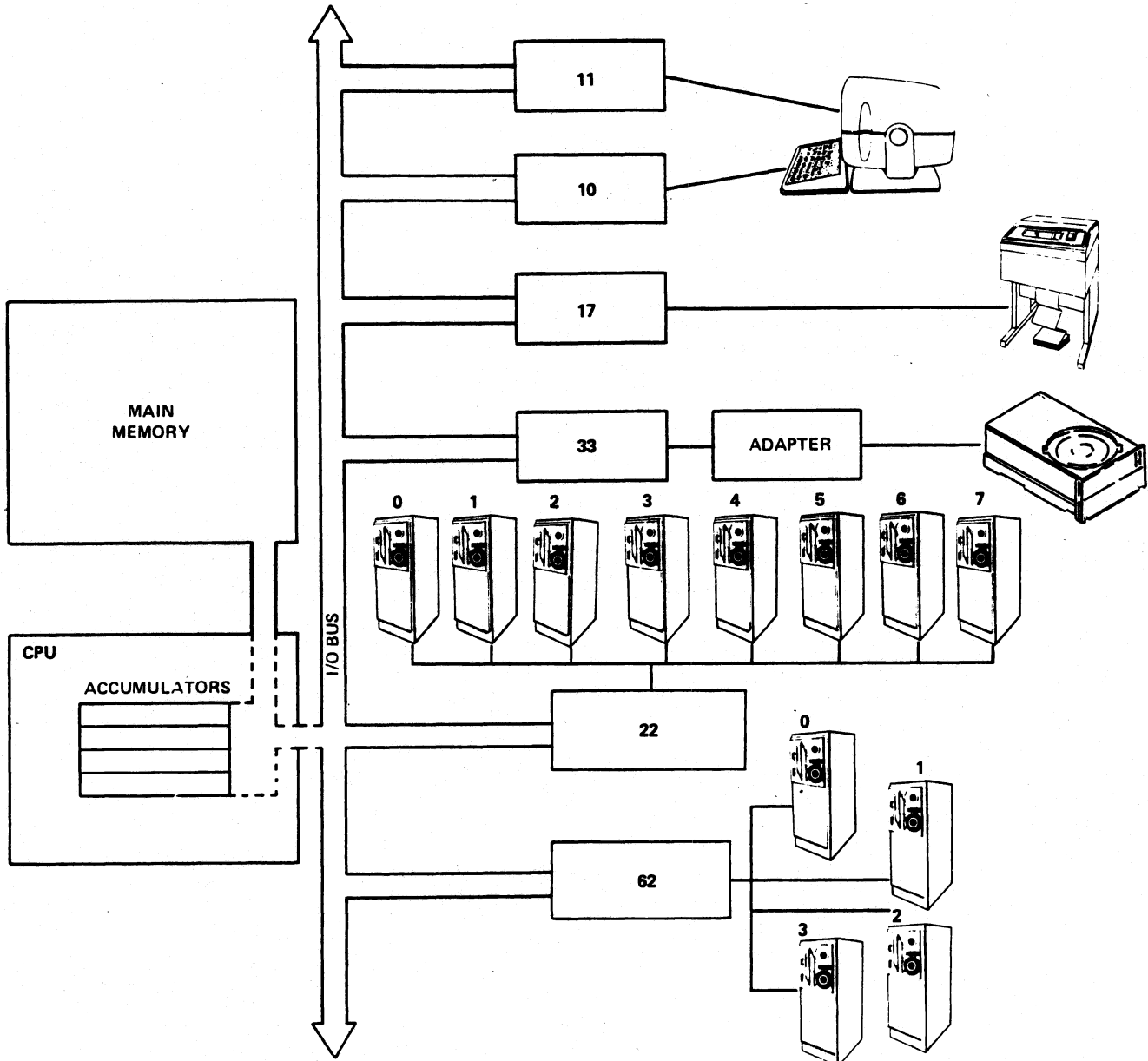

CS-00907

Figure 2.14 Device Codes and Unit Numbers

Module 2

Exercise

Match the following terms with their correct definition:

1. _____ Page
 2. _____ Core
 3. _____ Semiconductor Memory
 4. _____ Byte
 5. _____ Binary
 6. _____ Octal
 7. _____ ROM
 8. _____ PC
 9. _____ ALU
 10. _____ MAP
 11. _____ Address
 12. _____ Device Code
 13. _____ Word
 14. _____ Accumulators
 15. _____ Controller
- a. 8 bits
 - b. A number system with eight digits
 - c. A unique number associated with each byte and word that identifies its location in memory
 - d. 2 bytes
 - e. Performs arithmetic operations in the CPU
 - f. Translates logical addresses into physical addresses
 - g. An easily accessible limited storage area in the CPU for the temporary storage and manipulation of data
 - h. A unique number assigned to each controller that allows the CPU to differentiate between controllers
 - i. 1,024 words
 - j. Memory that holds information magnetically
 - k. A number system with two digits
 - l. A 15 bit location in the CPU that holds the address of the next instruction to be executed
 - m. Memory that contains permanently stored information
 - n. The interface between the computer and a peripheral device
 - o. Memory that holds information electrically (the information is volatile)

Module 2

Exercise Answers

1. i
2. j
3. o
4. a
5. k
6. b
7. m
8. l
9. e
10. f
11. c
12. h
13. d
14. g
15. n

HARD COPY

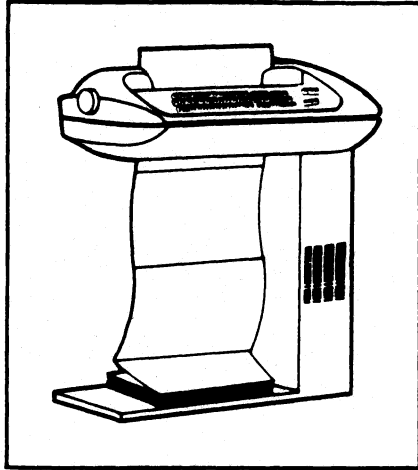

SOFT COPY

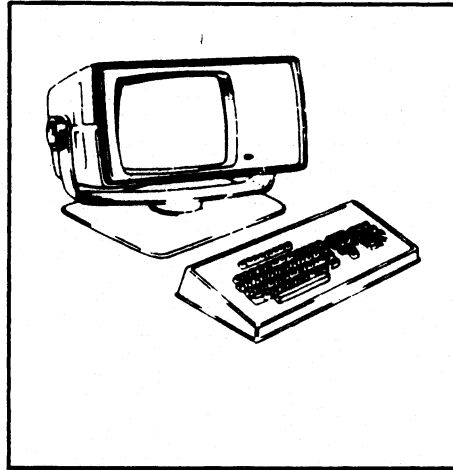

COMBINATION HARD COPY/SOFT COPY

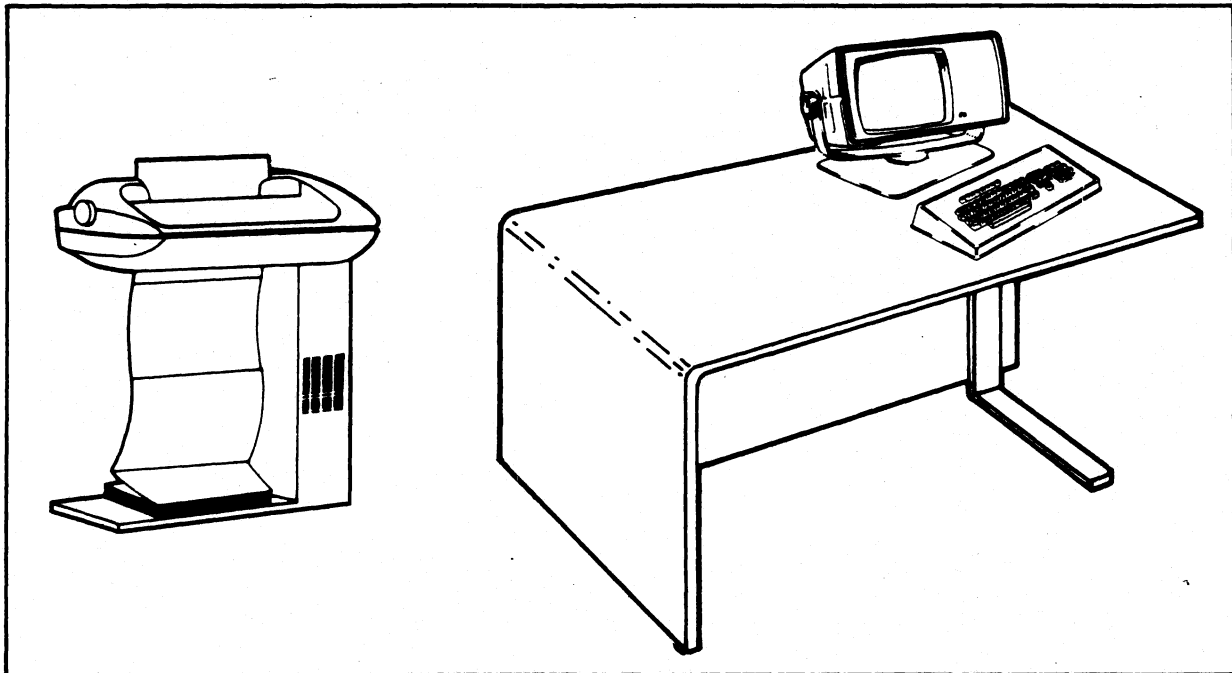

CS-00908

Figure 2.15 The Interactive Terminal

ASCII Code: Associates a Unique Number with Each of the 128 Characters

A PARTIAL LIST:	KEY				KEY			
	DECIMAL	OCTAL	HEX	SYMBOL	DECIMAL	OCTAL	HEX	SYMBOL
	48	060	30	0	65	101	41	A
	49	061	31	1	66	102	42	B
	50	062	32	2	67	103	43	C
	51	063	33	3	68	104	44	D
	52	064	34	4	69	105	45	E
	53	065	35	5	70	106	46	F
	54	066	36	6	71	107	47	G
	55	067	37	7				
	56	070	38	8	72	110	48	H
	57	071	39	9	73	111	49	I
	58	072	3A	:	74	112	4A	J
	59	073	3B	;	75	113	4B	K
	60	074	3C	<	76	114	4C	L
	61	075	3D	=	77	115	4D	M
	62	076	3E	>	78	116	4E	N
	63	077	3F	?	79	117	4F	O
	64	100	40	@				

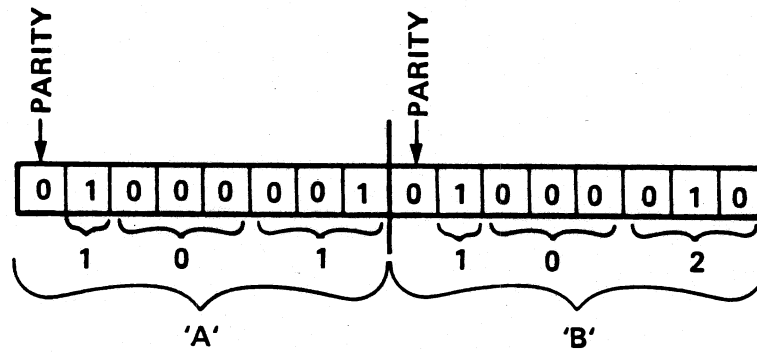

CS-00909

Figure 2.16 ASCII Character Code

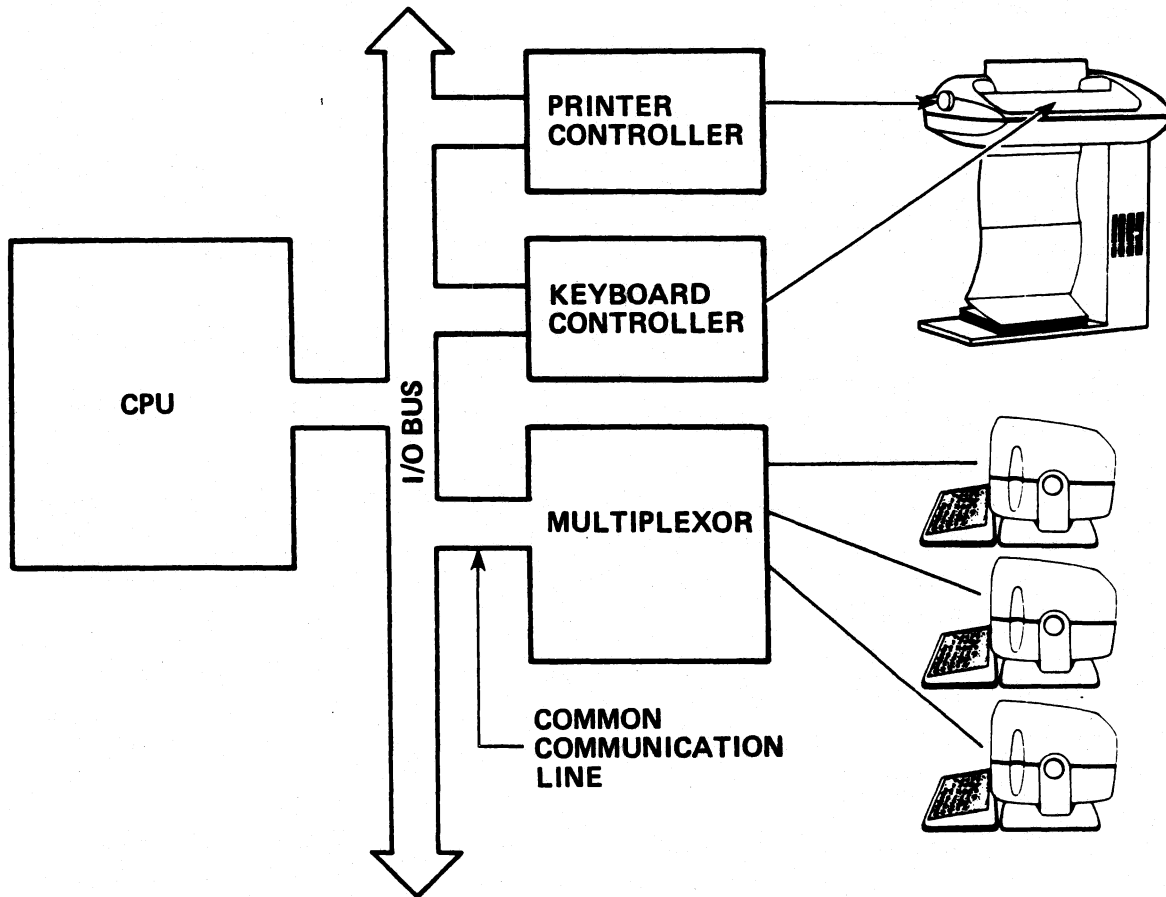

CS-00910

Figure 2.17 Multiplexor

- **Baud Rate** — The number of information bits that can be transmitted each second over a communications line.

Dasher Display 6052/6053

The 6052 and 6053 Dasher display terminals share the following features:

- Soft-copy input/output devices
- Operate in full-duplex mode, which means that they can transmit and receive information simultaneously
- Consist of two units:
 1. A CRT (Cathode Ray Tube) display
The display receives information (output) from a computer when it is online and from the keyboard when it is operating in local (offline) mode. A blinking underscore, called a cursor, defines the location of a character on the screen.
 2. A keyboard
The keyboard transmits information (input) to the computer when you type on the keys in online mode. Offline, it transmits information directly to the display. The keyboard contains four keypads: main, numeric, screen management, and user function.

Model 6052 is the basic terminal, using the uppercase ASCII character set.

Model 6053 is the enhanced terminal, using the upper/lowercase ASCII character set.

You may have either a Model 6054 or 6055 printer option. The printers provide a hard copy (printed page) of the information displayed on the screen. The Model 6054 option allows the display to be connected to any ASCII-based serial printer with an EIA RS-232C interface. Model 6055 connects a 6041 Dasher Receive-Only (RO) printer to the display as a hard-copy device.

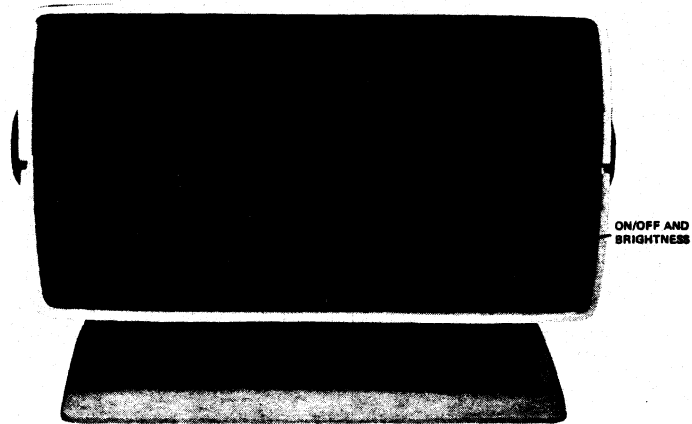

CS-00911

Figure 2.18 Display Front Panel

A single knob controls the power switch and CRT screen brightness:

- When you pull out the knob, the display power is turned on.
- When you push it in, the power is turned off.
- When you rotate the knob clockwise, the screen brightens.
- When you rotate it counterclockwise, the screen darkens.

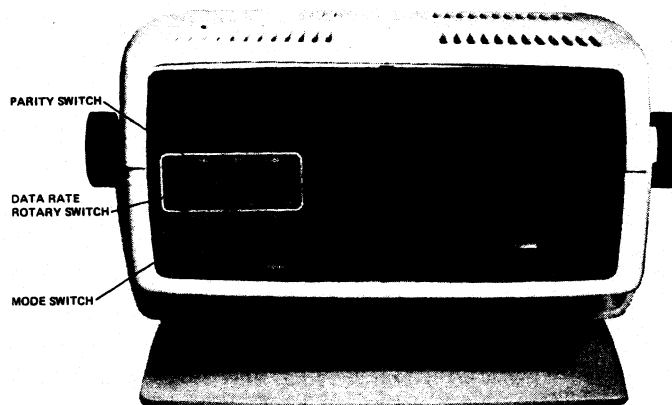

CS-00912

Figure 2.19 Display Rear Panel

Data Rate

When your terminal is installed, set the data transmission (baud) rate so that it is compatible with your system. You select the rate by moving the DATA RATE rotary switch to one of its 10 positions. (For further information, see the technical reference, *DASHER Display Terminals 6052, 6053*, No. 014-000077.)

Parity

Parity checks are a method of error detection. You can select the parity computation to be performed by the display terminal by moving the PARITY slide switch to one of its three positions: EVEN, ODD, or the central, unmarked position for mark parity. Mark parity means that the parity bit is always a one. Again make sure the parity you choose is compatible with your system. (For further information, see the technical reference, *DASHER Display Terminals 6052, 6053*, No. 014-000077.)

Note: When the data received by the display contains either a parity or transmission error, the error is indicated by a question mark on the Model 6052 and by a 5 x 7 block on the Model 6053 display screen.

Mode

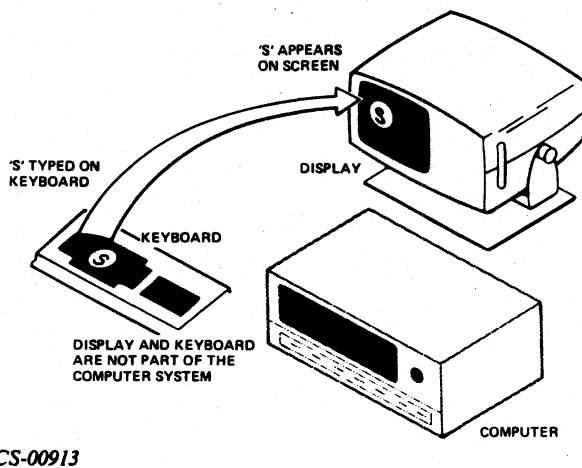

Figure 2.20 Local (Offline) Operation

You select the operating mode of the terminal by moving the MODE slide switch to one of its two positions: LOCAL or LINE.

In LOCAL (offline) mode, information you enter on the keyboard is sent directly to the display so that typing on the keyboard has a very similar effect to typing on a typewriter. In this mode your terminal is *not* part of the computer system.

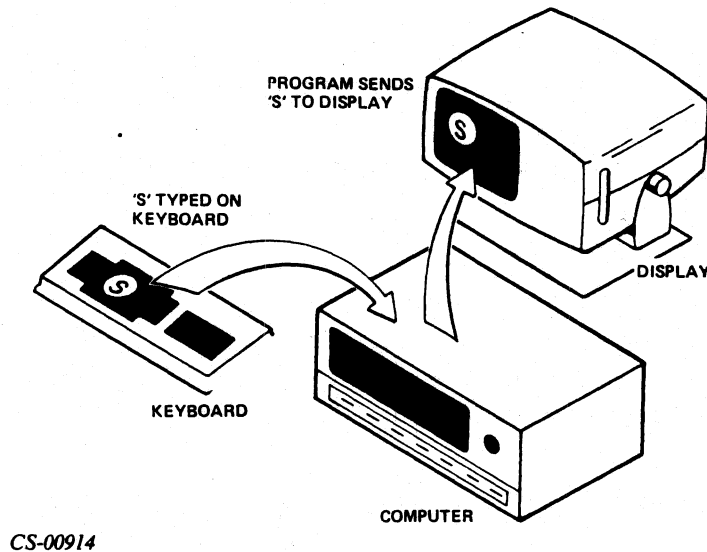

Figure 2.21 Line (Online) Operation

In LINE (online) mode, the keyboard and the display function as two independent units. They become part of the computer system, and the response of the display is controlled by the program in the system. Thus, typing a character on the keyboard will not result in the character appearing on the screen unless a program exists to send (echo) that character to the display. Similarly, typing a control character when online will have no effect on the screen unless a program defines an effect for the particular control character.

The display unit is mounted on a pedestal, which allows you to move the display in both horizontal and vertical directions. This enables you to adjust the position of the screen so it is comfortable for you.

Caution: Do not cover the ventilation openings in the top cover of the display unit, because overheating may cause an operational failure.

Dasher Display D100/D200

Dasher D100 and D200 display terminals share the following features:

- Soft-copy input/output devices
- Operate in full-duplex mode, which means they can transmit and receive information simultaneously
- Support American, British, Danish/Norwegian, French, German, Spanish, and Swedish/Finnish character fonts

- Consist of two units:

1. A CRT (Cathode Ray Tube) display

The display receives information (output) from a computer when it is online and from the keyboard when it operates in local (offline) mode. A solid white block, called a cursor, defines the location of a character on the screen.

2. A keyboard

The keyboard transmits information (input) to the computer when you type in online mode. In offline mode, it transmits information directly to the display. The D100 keyboard contains two keypads: main and cursor/numeric. The D200 keyboard contains four keypads: main, screen management, numeric, and user function.

They contain a self-test program. The display automatically executes a diagnostic (self-test) program each time it is turned on. This program verifies that the terminal is operating properly.

They support ASCII-based serial printers. You can purchase a Dasher TP1 or TP2 printer and the EIA RS-232C interface that connects the printer to the display. The printer provides a hard copy (printed page) of the information displayed on the screen.

A single knob controls the power switch and CRT screen brightness:

- When you pull out the knob, the display power is turned on.
- When you push in the knob, the power is turned off.
- When you rotate the knob clockwise, the screen brightens.
- When you rotate it counterclockwise, the screen darkens.

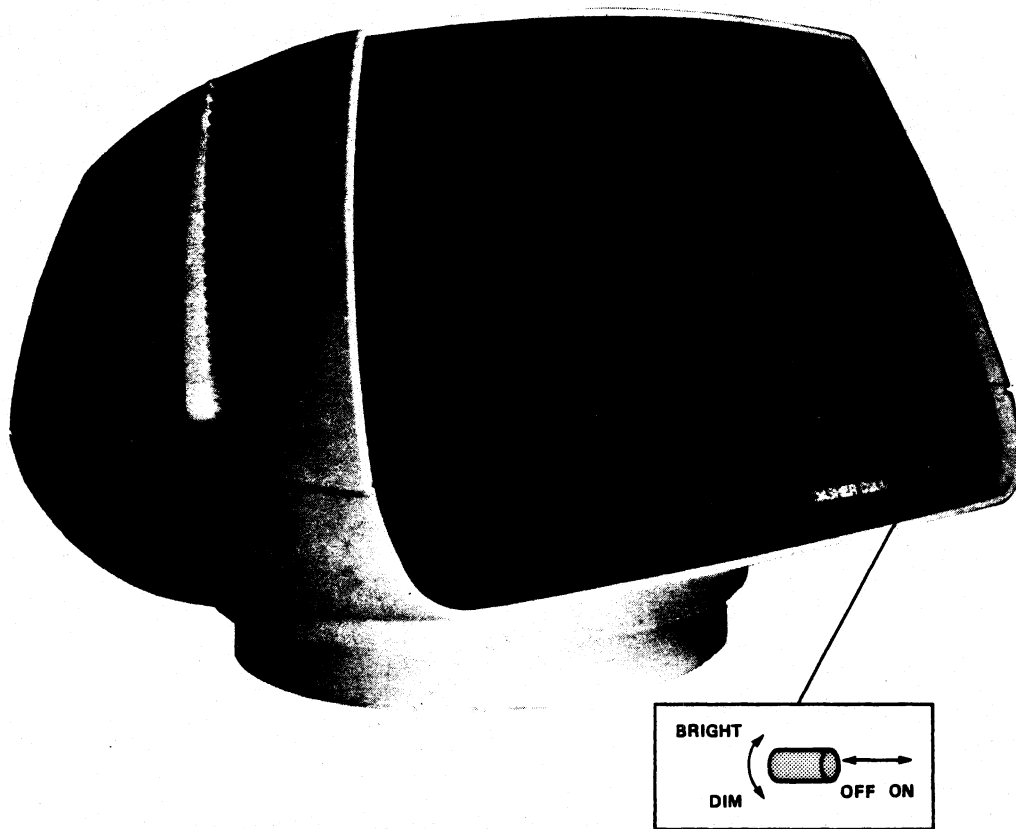

CS-00915

Figure 2.22 Display Front Panel

Note: Do not place anything on top of the display. Covering the cooling vents may cause the terminal to overheat.

When the display power is turned on, the power-up diagnostic automatically checks out the terminal. About 10 sec later, the cursor (a solid white block) appears in the upper-left corner of the screen. The terminal is now ready to receive commands.

If the cursor fails to appear after a 10-sec delay or the terminal beeps and displays a letter in the top center of the screen, the diagnostic has detected a problem.

You select the operating mode of the terminal in the following manner. On D100 keyboards, press the DEL (delete) key while holding down the CMD (command) key. On D200 keyboards, press the ON LINE key while holding down the CMD (command) key. Pressing these keys alternately switches the terminal online or off-line. The terminal is online when the ON LINE light is on.

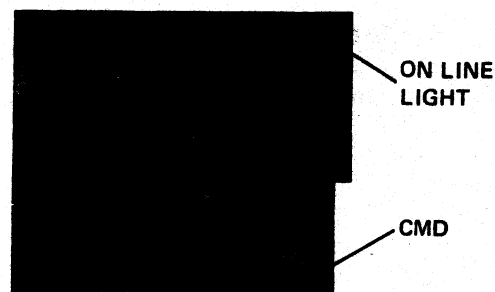

CS-00916

Figure 2.23 D100 ON/OFF Line Mode Control

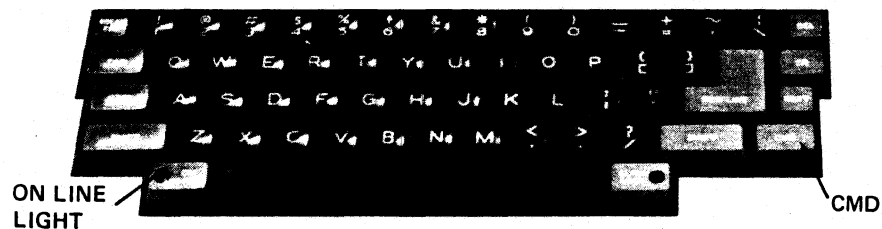

CS-00917

Figure 2.24 D200 ON/OFF Line Mode Control

Note: When you turn the power on, the terminal automatically enters online mode unless the self-test diagnostic detects an error or the cable connecting the display to the computer is not plugged in.

In offline mode, information you enter on the keyboard is sent directly to the display so that typing on the keyboard has a very similar effect to typing on a typewriter. In this mode, the terminal is not part of the computer system.

In online mode, the keyboard and the display function as two independent units. They become part of the computer system, and the response of the display is controlled by the program in the system. Thus, typing a character on the keyboard will not result in the character appearing on the screen unless a program exists to send (echo) that character to the display. Similarly, typing a control character when online will have no effect on the screen unless a program defines an effect for the particular control character.

TP1 Terminal

The Dasher TP1 terminal printer is either:

- A 6040/6042 keyboard-send-receive (KSR) model with a keyboard for entering and sending information and a printer for receiving and recording information.
- A 6041/6043 receive-only (RO) model with only a printer for receiving and recording information.

The speed at which your terminal operates depends both on the particular model you have and the speed selected for your applications. Models 6040 KSR and 6041 RO operate at either 30 or 60 characters per second, while Models 6042 KSR and 6043 RO operate at either 10, 15, or 30 characters per second.

Operating the Dasher TP1 is simple. To get it ready to use all you have to do is power it up, make sure it has paper, and switch it online.

Main Controls

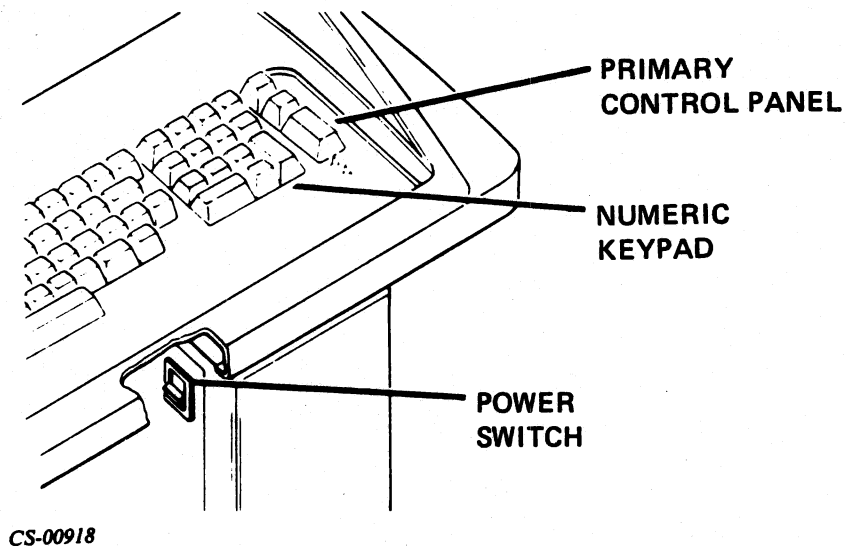

Figure 2.25 Control Locations

The Power Switch is located on the inner side of the pedestal and operates as follows:

UP/ON — The power is turned on, the fan runs, and the RDY (Ready) light glows. The printhead returns to the beginning of the line.

DOWN/OFF — The power, fan, and RDY (Ready) light are turned off.

If your terminal is a KSR model, the main operator controls are located either on a Standard Control Panel or to the right of the Numeric Keypad. If your terminal is an RO model, these controls are on the standard control panel.

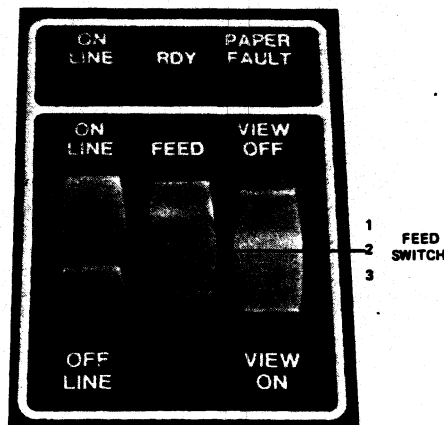

CS-00919

Figure 2.26 Standard Control Panel

RDY — When lit, your terminal is operating normally.

ON LINE — When lit, your terminal is connected to the computer or communications system.

PAPER FAULT — When lit, your terminal is out of paper. If your terminal has the Form Feed option, this light also glows if there is a line count error.

ON/OFF LINE — Two-position toggle switch. In the ON LINE position, your terminal is connected to the computer or communications system. In the OFF position, your terminal is disconnected from the system.

VIEW OFF/VIEW ON — Two-position toggle switch. In the ON position, the View Print feature is activated. In the OFF position, this feature is disabled.

FEED — A three-position switch for controlling paper feed.

Position 1: single line feed

Position 2: no line feed

Position 3: continuous line feed.

Note: If your terminal has the form feed option, position 3 advances the paper to the top of the next form.

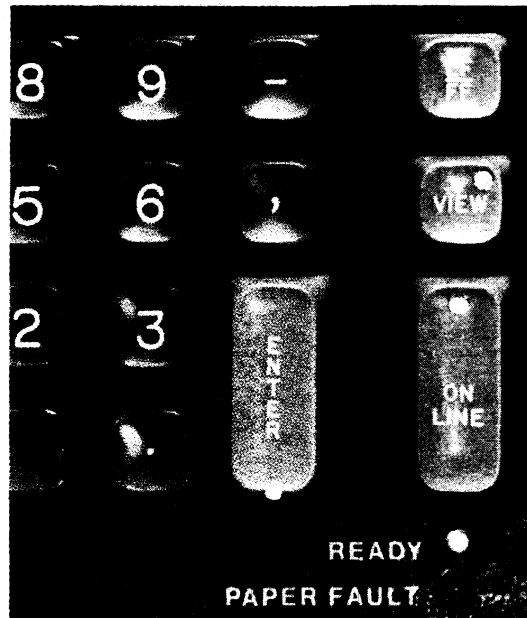

CS-00920

Figure 2.27 Numeric Keypad

READY — When lit, your terminal is operating normally.

ON LINE — Alternate action switch with indicator light. When pressed and the light glows, your terminal is connected to the computer or communications system. When pressed again and the light goes off, your terminal is disconnected from the system.

PAPER FAULT — When lit, your terminal is out of paper. If your terminal has the form feed option, this light also glows if there is a line count error.

VIEW — Alternate action switch with indicator light. In the on position, the View Print feature is activated. In the off position, this feature is disabled.

LF/FF — Momentary contact switch. Operates only when the terminal is offline. Pressing the switch for less than a second advances the paper to the next line (line feed). If the form feed option is installed, pressing the switch for longer than a second advances the paper to the top of the next form (form feed). If the form feed option is not present, holding the switch down advances the paper at about 1-sec intervals until the switch is released.

Note: If your terminal has the form feed option, pressing this switch for 2 sec or longer advances the paper to the top of the next form.

Dasher LP2 and TP2

The Dasher LP2 or TP2 printer is either a receive-only (RO) printer or a keyboard-send-receive (KSR) hard-copy terminal. Though models without a keyboard are considered printers and models with a keyboard are considered terminals, this Student Guide often uses the word *terminal* to apply to both.

Operating the Dasher LP2 or TP2 terminal is easy. To get it ready to use, all you have to do is power it up, make sure it has paper, and switch it online.

You control the operation of your printer or terminal using the power switch and switches located on the primary and secondary control panels. If you have a terminal, you may also control its operation via the keyboard and the optional numeric keypad. The operation of the primary control panel is described later in this module.

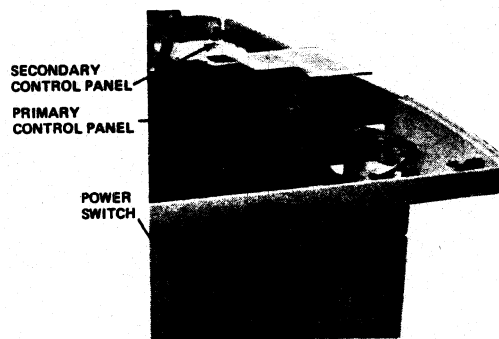

CS-00921

Figure 2.28 Control Locations, RO Printer

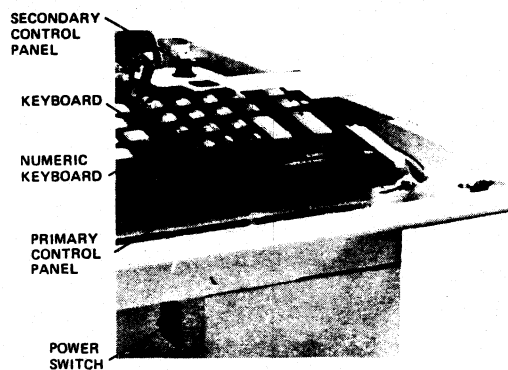

CS-00922

Figure 2.29 Control Locations, KSR Terminal

Power Switch

This two-position switch is located on the inner side of the pedestal and operates as follows:

UP/ON — The power is turned on, the fan runs, and the RDY (Ready) light glows. The printhead returns to the beginning of the line.

DOWN/OFF — The power, fan, and RDY (Ready) light are turned off.

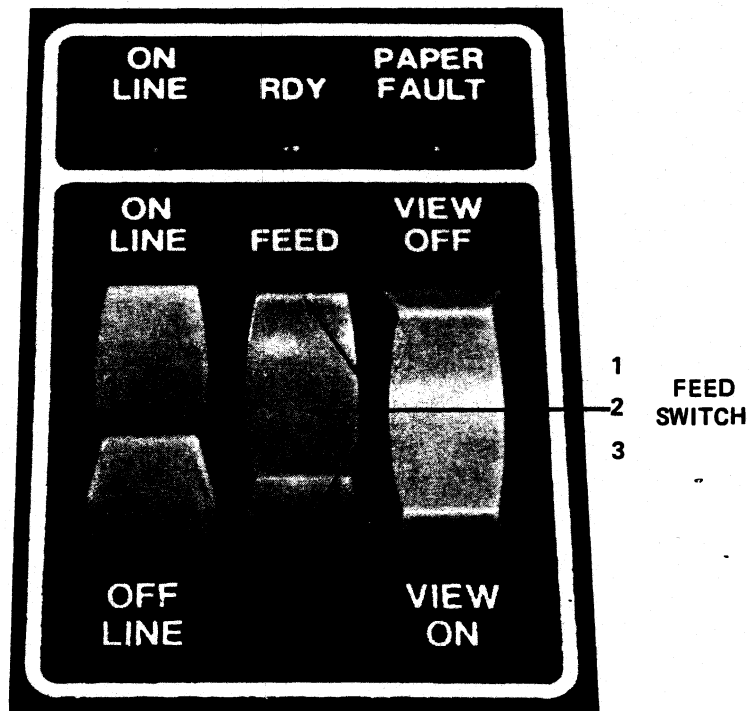
Primary Control Panel, RO Printer

CS-00919

Figure 2.30 Primary Control Panel, RO Printer

ON LINE (indicator light) — When lit, your printer is online (under control of the computer). When not lit, your printer is offline.

RDY (ready indicator light) — When lit, your printer is able to accept characters. When not lit, either your printer is not able to accept characters (i.e., its character buffer is full), it is not powered up, or there is a fault condition.

Note: The RDY light will blink on and off during normal operation.

FAULT (indicator light) — When lit, your printer is either out of paper, the paper feed mechanism is jammed, the ribbon cartridge is jammed or indicates the existence of other hardware faults.

ON/OFF LINE (two-position switch) — When in the ON LINE position, your printer is under the computer's control. When in the OFF LINE position, your printer is not under the computer's control. However, if a fault condition exists, the printer can be offline (RDY indicator extinguished), even though the ON/OFF LINE switch is in the ON LINE position.

FEED (three-position switch) — Pressing the switch to position 1 advances the paper one line. Position 2 is the normal position. Pressing the switch to position 3 advances the paper to the top of the next form if the automatic form feed option is installed. If the automatic form feed option is not installed, pressing the switch to position 3 advances the paper until you release the switch.

VIEW ON/OFF (two-position switch) — When in the VIEW ON position, the view feature is enabled. When in the VIEW OFF position, the view feature is disabled. When this feature is enabled and there is a pause in printing, the printhead automatically moves several spaces to the right so you can see the last character printed. If the printhead is near the end of the line when there is a pause in printing, the printhead moves to the left instead of the right.

Primary Control Panel, KSR Terminal



CS-00920

Figure 2.31 Primary Control Panel, KSR Terminal

VIEW (indicator light) — When lit, your terminal's view feature is enabled. When not lit, the feature is disabled.

ON LINE (indicator light) — When lit, your terminal is online (under control of the computer). When not lit, your terminal is offline.

READY (indicator light) — When lit, your terminal is able to accept characters. When not lit, either your printer is not able to accept characters (i.e., its character buffer is full), it is not powered up, or there is a fault condition.

Note: The RDY light will blink on and off during normal operation.

FAULT (indicator light) — When lit, your terminal is either out of paper, the paper feed mechanism is jammed, the ribbon cartridge is jammed or indicates the existence of other hardware faults.

LF/FF (momentary contact switch) — Operates only when the terminal is offline. Pressing the switch for less than a second advances the paper to the next line (Line Feed). If the automatic form feed option is installed, pressing the switch for more than a second advances the paper to the top of the next form (form feed). If the automatic form feed option is not installed, pressing the switch for more than a second advances the paper at about 1-sec intervals until the switch is released.

VIEW (alternate action switch) — When pressed and the light glows, view mode is enabled. When pressed again and the light goes off, view mode is disabled. When this feature is enabled and there is a pause in printing, the printhead automatically moves several spaces to the right so you can see the last character printed. If the printhead is near the end of the line when there is a pause in printing, the printhead moves to the left instead of the right.

ON LINE (alternate action switch) — When pressed and the light glows, your terminal is connected to the computer or communications system. When pressed again and the light goes off, your terminal is disconnected from the system.

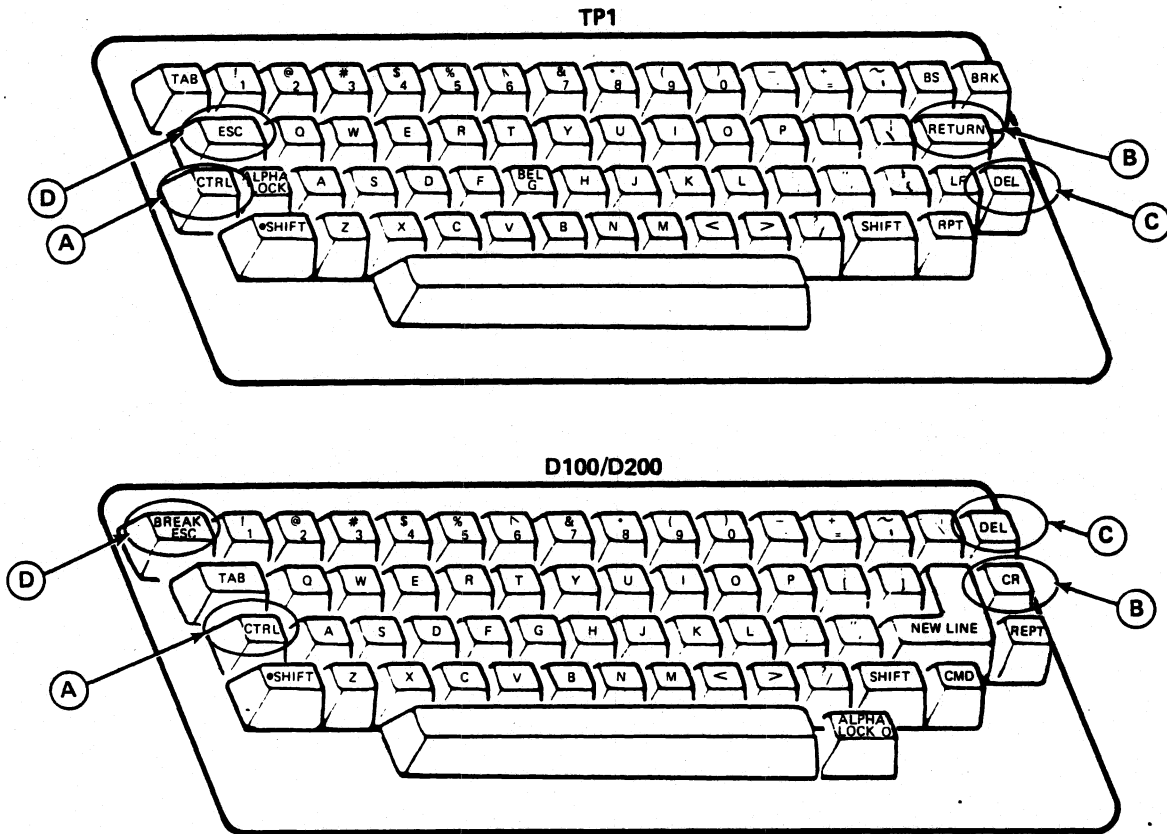

CS-00923

Figure 2.32 Main Keypads

- A — Control Key
- B — Carriage Return Key
- C — Delete or Rubout Key
- D — Escape Key (\$)

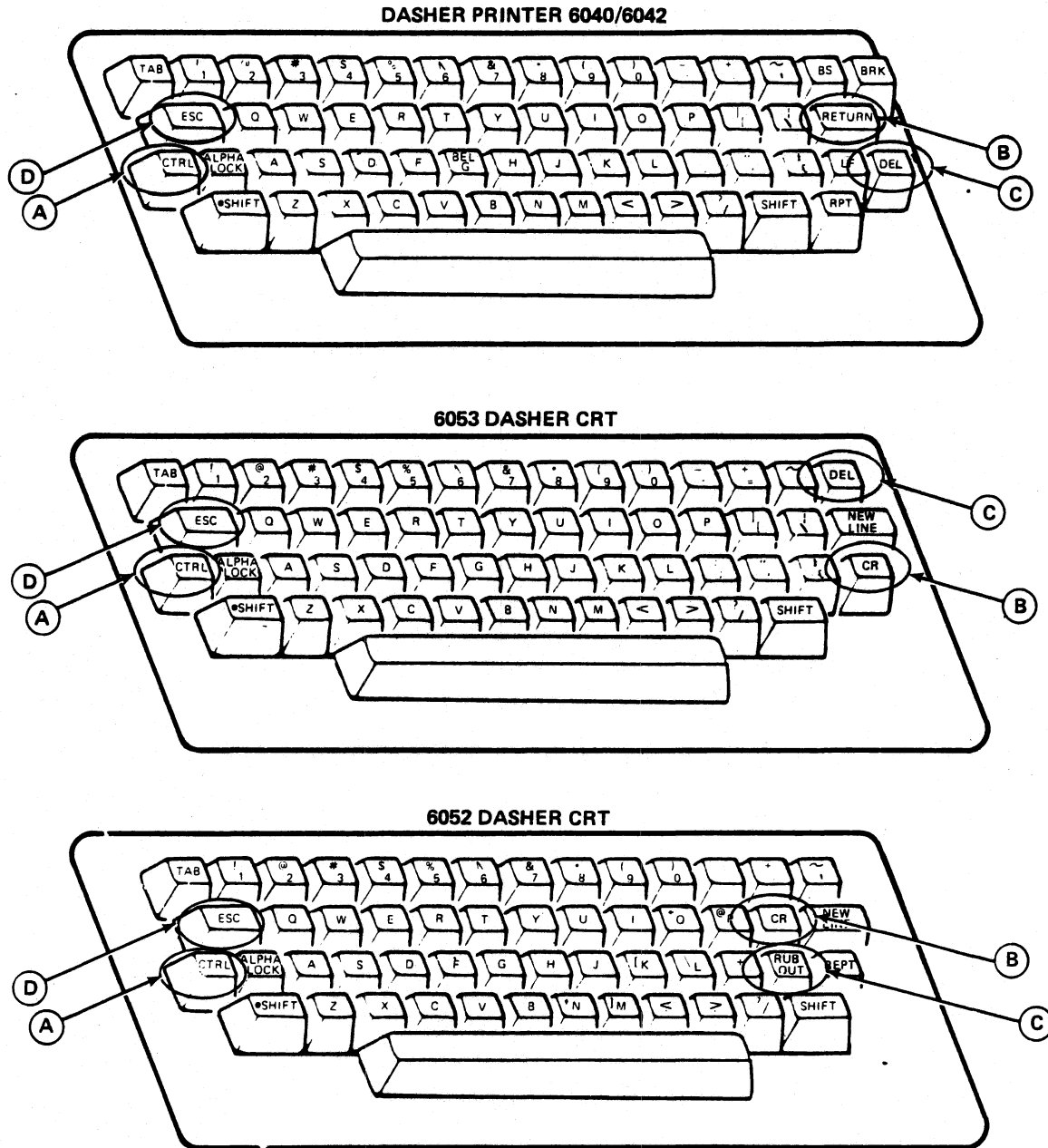

CS-00924

Figure 2.32 Main Keypads (Cont.)

- A — Control Key
- B — Carriage Return Key
- C — Delete or Rubout Key
- D — Escape Key (\$)

Mass Storage Devices

SEQUENTIAL

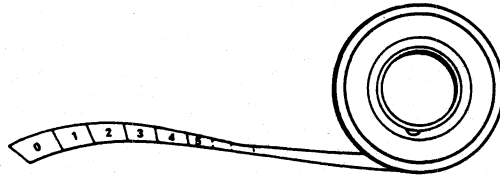

DIRECT ACCESS

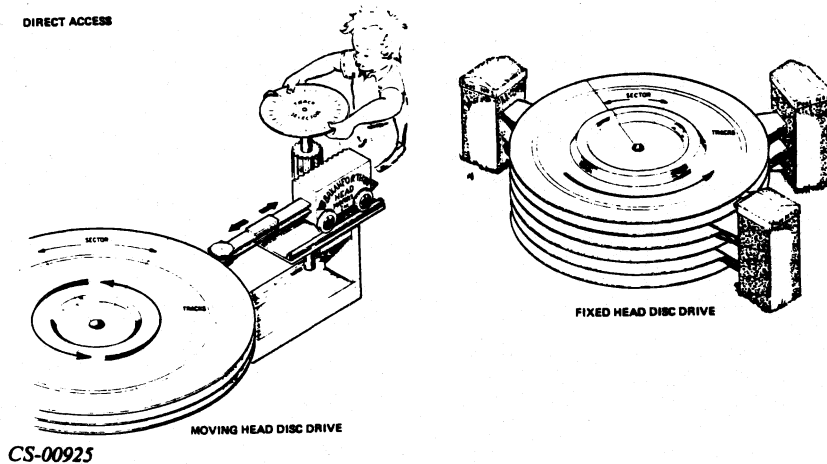

Figure 2.33 Secondary Storage

Disc Drives and Magnetic Tape Drives

At this point it is necessary for you to refer to the operator manuals inserted in the sleeve of the back cover. There are two manuals: *DGC Disc Drives — Operator's Manual* and *Magnetic Tape Transports — Operator's Manual*.

In the *DGC Disc Drives — Operator's Manual*, please read:

1. Introduction
2. The section that applies to your model number. (For Model 6097/6098/6099, read the text beginning on the next page.)

In the *Magnetic Tape Transports — Operator's Manual*, please read:

1. Introduction
2. The section that applies to your model number.

Stop the audiocassette tape now, and read the appropriate text in the Operator's Manuals.

6097/6098/6099 DG/Disc Subsystems

The 6097/6098/6099 DG/Disc Subsystems provide up to 13.7M bytes of disc storage for NOVA and ECLIPSE line computers. The Model 6098 is an integrated subsystem consisting of a controller and two moving head disc drives — a rigid disc drive with a storage capacity of 12.5M bytes and a flexible disc drive with a storage capacity of 1.2M bytes. The Model 6099 consists of the controller and the rigid drive only. The Model 6097 consists of the controller and the flexible drive only.

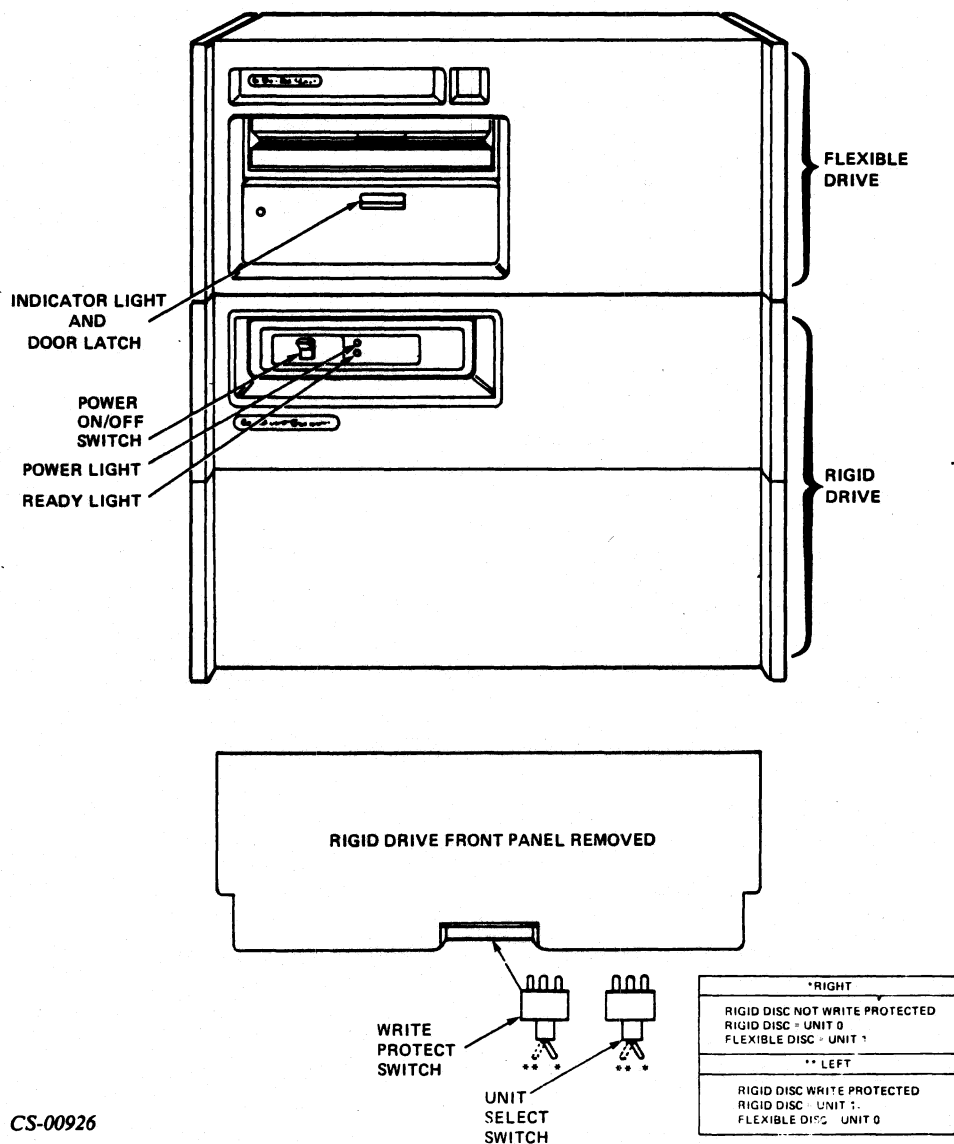

CS-00926

Figure 2.34 6098/6099 DC/Disc Subsystems

The following switches and indicators are on the front panel of the rigid drive.

POWER ON/OFF — Setting this switch to the on position powers up the drive. Setting the switch to off shuts down the drive completely. When the power switch is turned off, there is a 1-sec delay before the drive is powered down. During this time, the heads are moved out of the recording area of the disc and into the landing area where the heads can land on the disc as it stops. On the 6098 integrated subsystem, the power switch also powers up and powers down the flexible disc.

POWER — When this indicator is on, the drive is powered up and the voltages are within operating specifications.

READY — When this indicator is on, the spindle is up to speed and the heads are not moving. The ready light is off during any head positioning (seek, recalibrate) operations.

If you remove the front panel, two switches will be exposed: Unit Select and Write Protect.

UNIT SELECT — When this switch is to the right, the rigid drive is unit 0 and the flexible drive is unit 1. When it is switched to the left, the flexible drive is unit 0 and the rigid drive is unit 1. This switch is only used on the 6098 integrated disc subsystem.

WRITE PROTECT — When this switch is to the left, write operations cannot be performed on the rigid disc.

The flexible drive's front panel has one indicator light. This light is on when the power and spindle speed are within specifications, a Diskette/4 is installed, and the heads are loaded. If the drive is idle for 1.5 sec, the heads will unload and this light will go out.

Diskettes

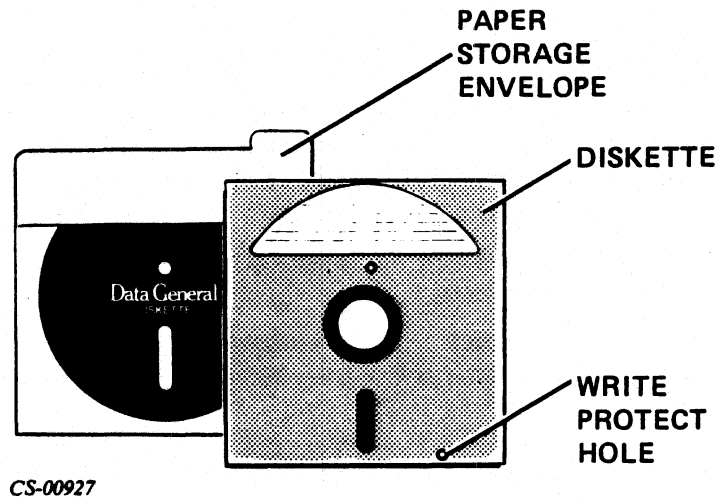

Figure 2.35 Diskette

Diskettes are small magnetic discs enclosed in protective packets. Certain areas of the diskette are exposed through openings in the packet. While the drive is operating, the diskette rotates within the packet, which remains stationary in the drive. The recording surface is exposed at the Read/Write opening where the transcription head contacts the diskette. Cover the Write Protect hole near the edge of the packet with the tape provided (see *Inserting a Diskette/4 in the Flexible Drive*).

You may attach an identification label to the packet, but you should attach it *only* as indicated on the packet, since the position of the label orients the diskette packet when you insert it in the drive.

Handling Diskettes

The following are precautions you should observe when handling diskettes to prevent loss of data:

- *Never* remove a diskette from its protective packet.
- Do not touch the parts of a diskette that are exposed at the various openings in the packet. Try to handle the packet only at the edges to preserve the recording surface.
- *Never* bend or fold a diskette.
- Always store a diskette in its paper storage envelope and in a clean, dry environment. The primary cause of loss of data is contamination of the recording surface. When not in use, return the diskette to its storage box and store in an upright position.

- Do *not* write on the identification label with an instrument such as a lead or grease pencil, which may deposit particles or other foreign matter on the diskette. It is recommended that you use a felt-tip marker to write on the label and that you write on the label *before* you attach it to the envelope.
- Keep all diskettes, including those with no data on them, away from strong magnetic fields. If you expose a diskette to a strong magnetic field, you may alter or destroy the data on it. Even if no data is on the diskette, exposing it to a magnetic field may alter or destroy the format that DGC supplies.
- Never use solutions such as alcohol or thinner to clear the diskette.
- When you transport diskettes with valuable data on them, pack them in a metal container.

Inserting a Diskette/4 in the Flexible Drive

To insert a Diskette/4 into the flexible drive, proceed as follows:

1. Remove the Diskette/4 from its paper storage envelope. If you want the drive to write on the Diskette/4, cover the write protect hole with a piece of opaque tape included with the Diskette/4s. Wrap the tape over the edge so that you cover both sides of the hole. If you want the Diskette/4 protected against writing, make sure the hole is clear.
2. Open the drive door by pressing the latch below the door.
3. Slide the Diskette/4 into the drive so that the write protect notch is in the left-rear corner of the drive. The Diskette/4 should slide in smoothly and then come to a stop in the drive.
4. Close the drive door by pushing it down until it latches.
5. The drive is now ready to accept commands from the controller.

To remove a Diskette/4 from the flexible drive:

1. Wait for the indicator light to go out. Open the drive door by pressing the latch below it. The Diskette/4 will be pushed about half-way out of the drive.
2. Slide the Diskette/4 out of the drive and place it in its paper storage envelope.
3. Close the drive door so it latches shut (optional).

Front Panel and Programmed Console Operations

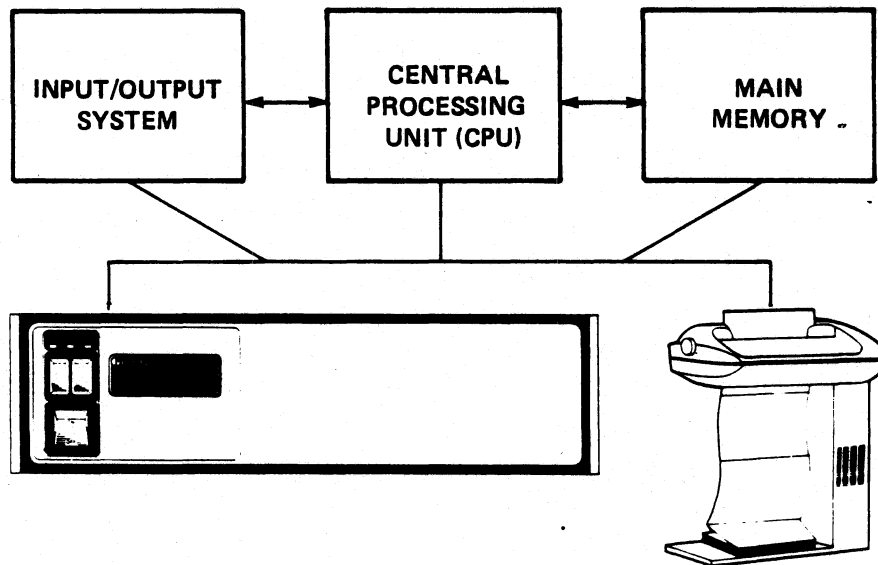
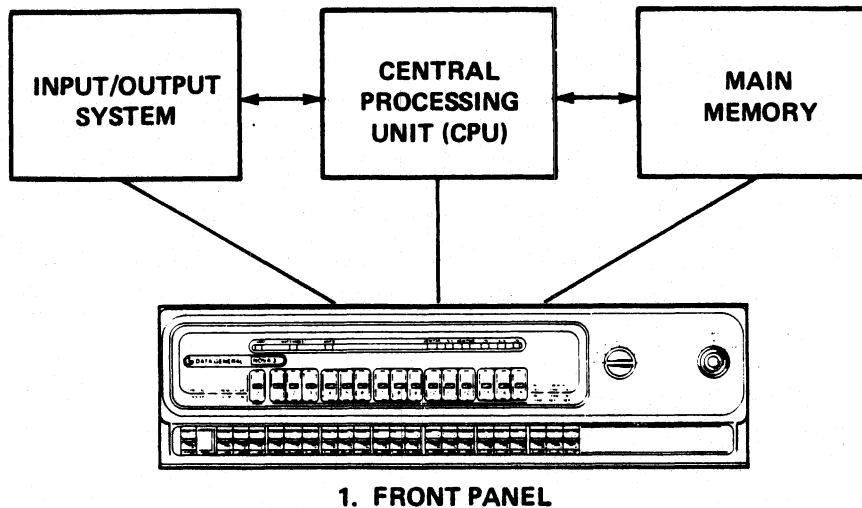

2. FRONT PANEL/PROGRAMMED CONSOLE

CS-00928

Figure 2.36 Front Panel and Programmed Console

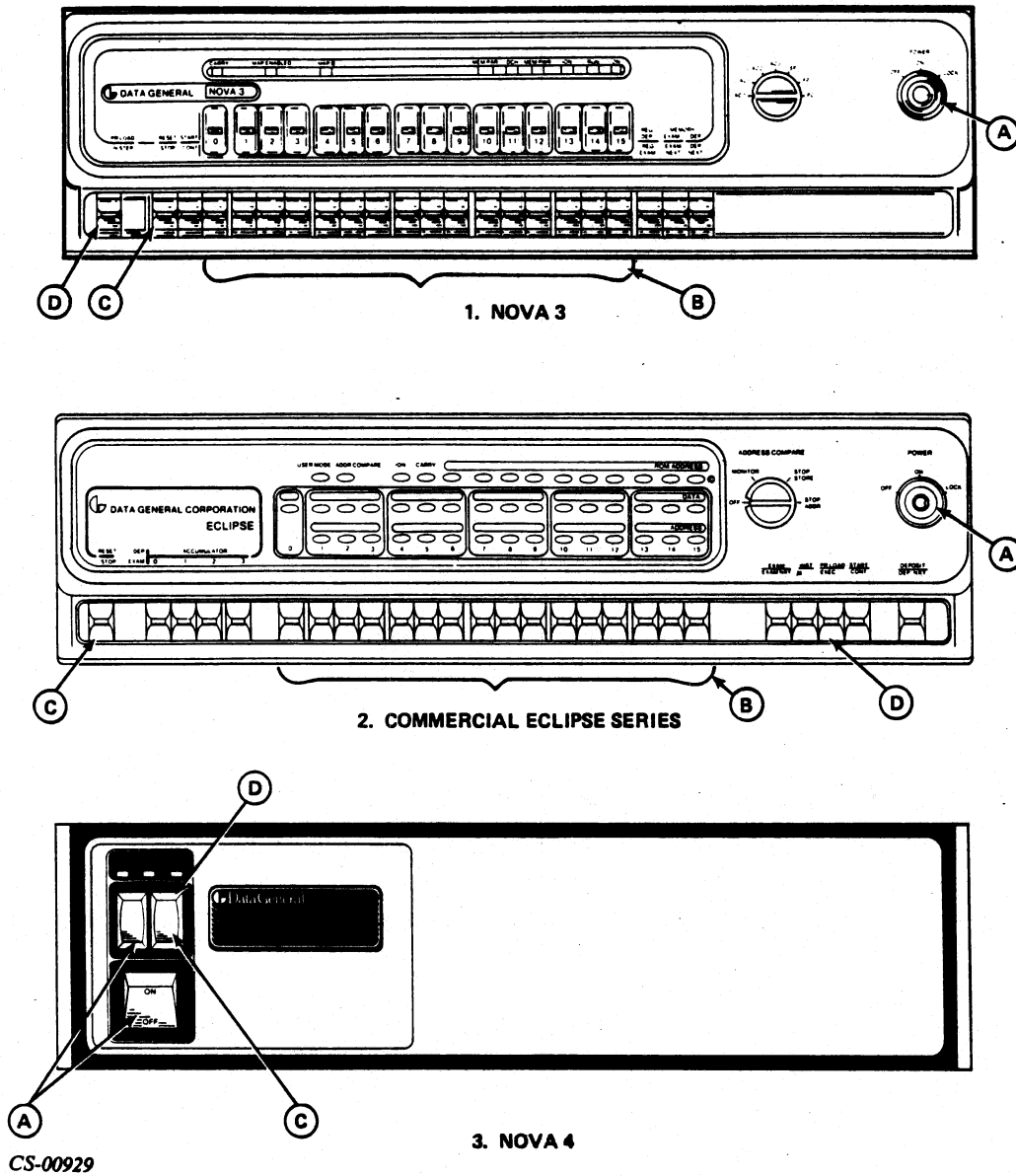

CS-00929

Figure 2.37 Data General Computer Front Panels

- A — Power On/Off
- B — Data Switches
- C — Reset
- D — Program Load

RDOS Overview

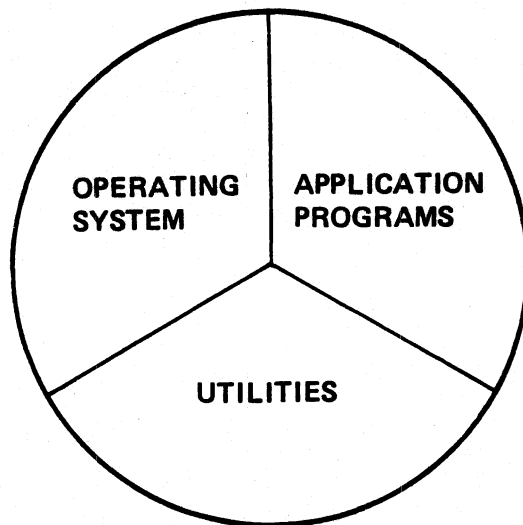

CS-00930

Figure 2.38 Classes of Software

- Application programs perform specific tasks.
- Utilities aid the programmer in the operation of the computer and in the development of applications programs.
- Operating system supervises operations; manages access to CPU, memory, and I/O devices.

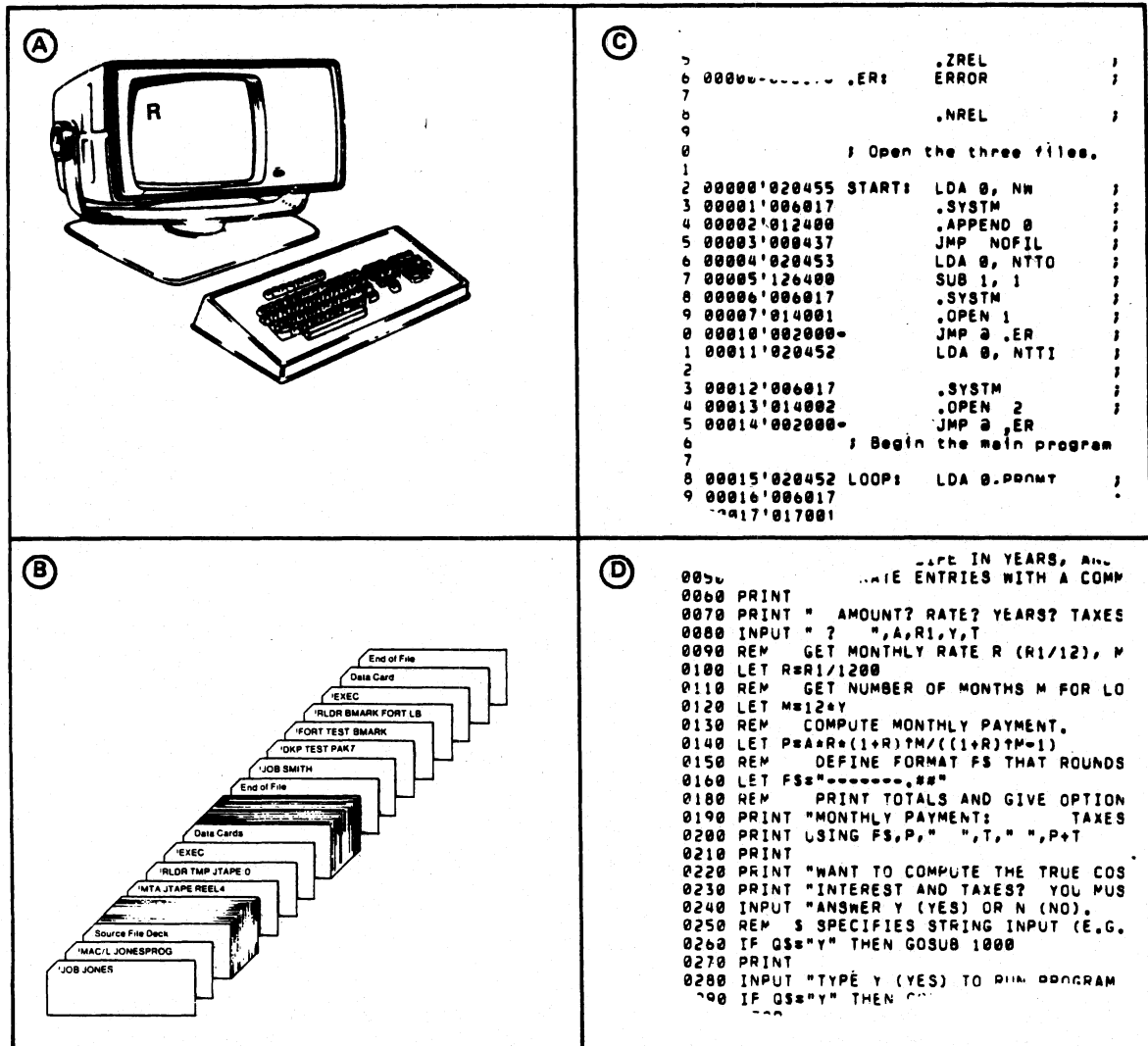

CS-00931

Figure 2.39 Communicating with RDOS

- A — Command Line Interpreter (CLI)
- B — Batch
- C — System and Task Calls in Assembly Language
- D — Indirectly, High-Level Language

What is a File?

- Collection of information
- Device

Filenames

- Disc Filenames
 1. String of 10 ASCII characters
 - Upper- and lower-case letters
 - Numbers
 - \$
 2. Extension: A period (.) followed by two ASCII characters
- Reserved Filenames (Devices)

Table 2.C Reserved Filenames

Device Name	Device
	Asynchronous Line Multiplexor (see QTY for device name).
\$CDR	Punched card reader; mark sense card reader.
CTn	Data General cassette unit n, first controller (n is in the range 0-7).
DKO	Data General Model 6001-6008 fixed-head disc, first controller.
DPn	Data General moving-head disc pack, first controller, unit n is 0, 1, 2, or 3.
DPnF	Top loader (dual-platter Disc Subsystem). For the first controller, unit n is number 0, 1, 2, or 3. This unit has two discs. The top (removable) disc is DPn, the fixed disc is DPnF. This controller also supports diskette drives.
DOn	Data General Model 6063/6064 fixed-head disc. The 6063 is single density, the 6064 is double density. n is 0, 1, 2, or 3.
DZn	6060 series disc unit, first controller. n is 0, 1, 2, or 3. The 6060 uses single-density discs, 6061 uses double-density discs.
\$DPI	Input dual processor link.
\$DPO	Output dual processor link.
\$LPT	80- or 132-column line printer.
MCAR	Multiprocessor communications adapter receiver.
MCAT	Multiprocessor communications adapter transmitter.
MTn	First controller, 7- or 9-track magnetic tape transport n, (n is in range 0-7).
\$PLT	Incremental plotter.
\$PTP	High-speed paper tape punch.
\$PTR	High-speed paper tape reader.
QTY	Asynchronous Line Multiplexor (ALM), asynchronous data communications multiplexor (QTY), or Universal Line Multiplexor (ULM).
\$TTI	Teletypewriter or display terminal keyboard.
\$TTO	Teletypewriter printer or CRT display.
\$TTP	Teletypewriter punch.
\$TTR	Teletypewriter reader.

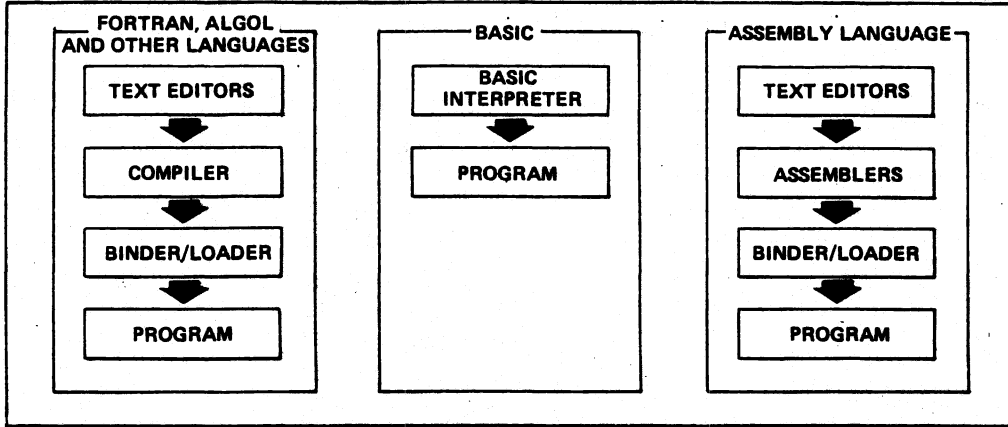

CS-00932

Figure 2.40 Program Development

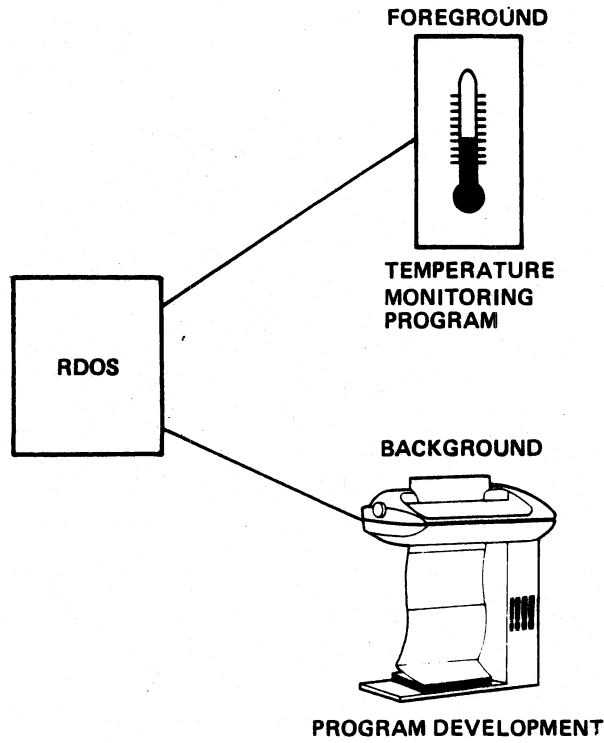

CS-00933

Figure 2.41 Foreground/ Background

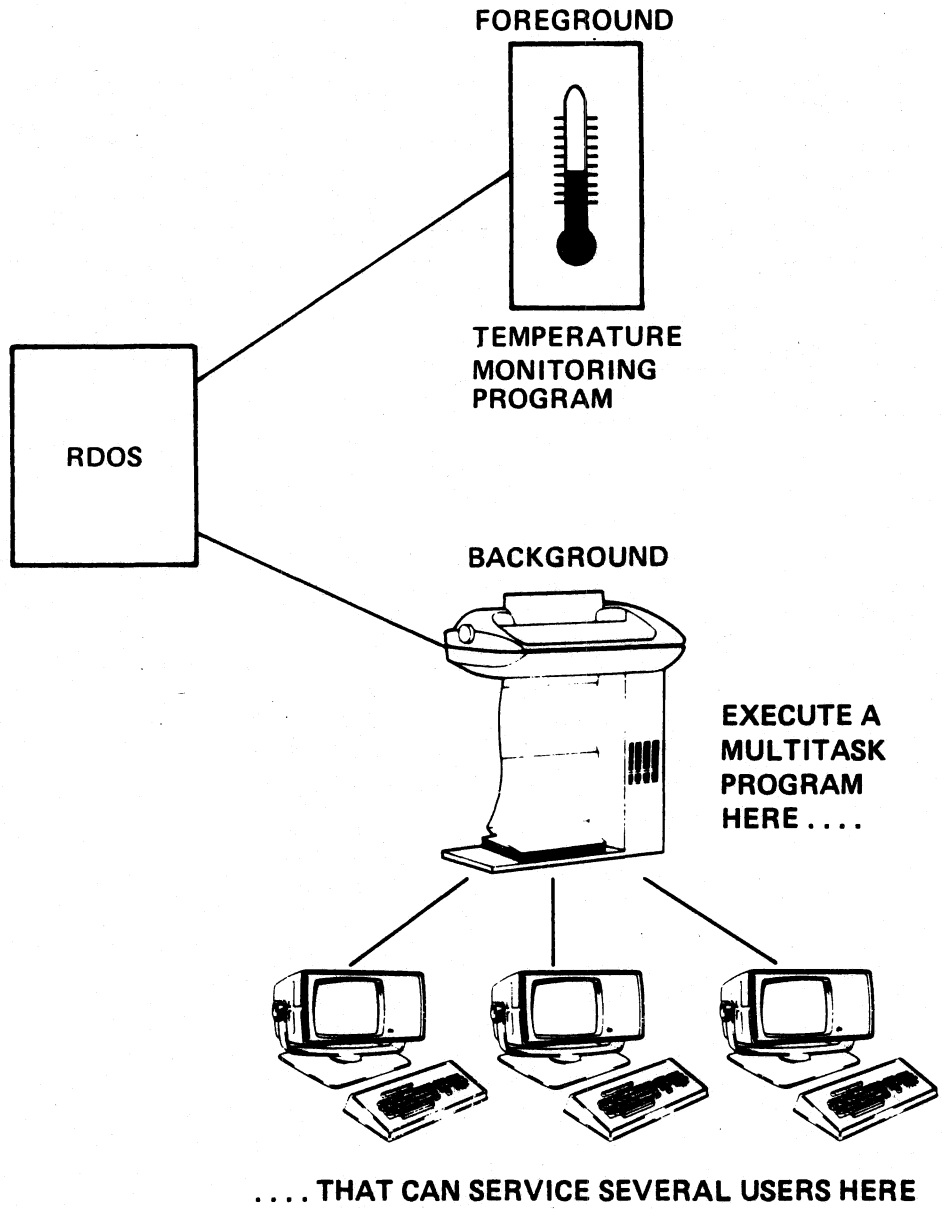

CS-00934

Figure 2.42 Multitasking

RDOS Flavors

URDOS	Unmapped NOVA
MRDOS	Mapped NOVA
NRDOS	Mapped NOVA 3 or NOVA 4
BRDOS	Unmapped ECLIPSE
ARDOS	Mapped ECLIPSE (S200 or C300)
ZRDOS	Mapped ECLIPSE (Any other ECLIPSE)

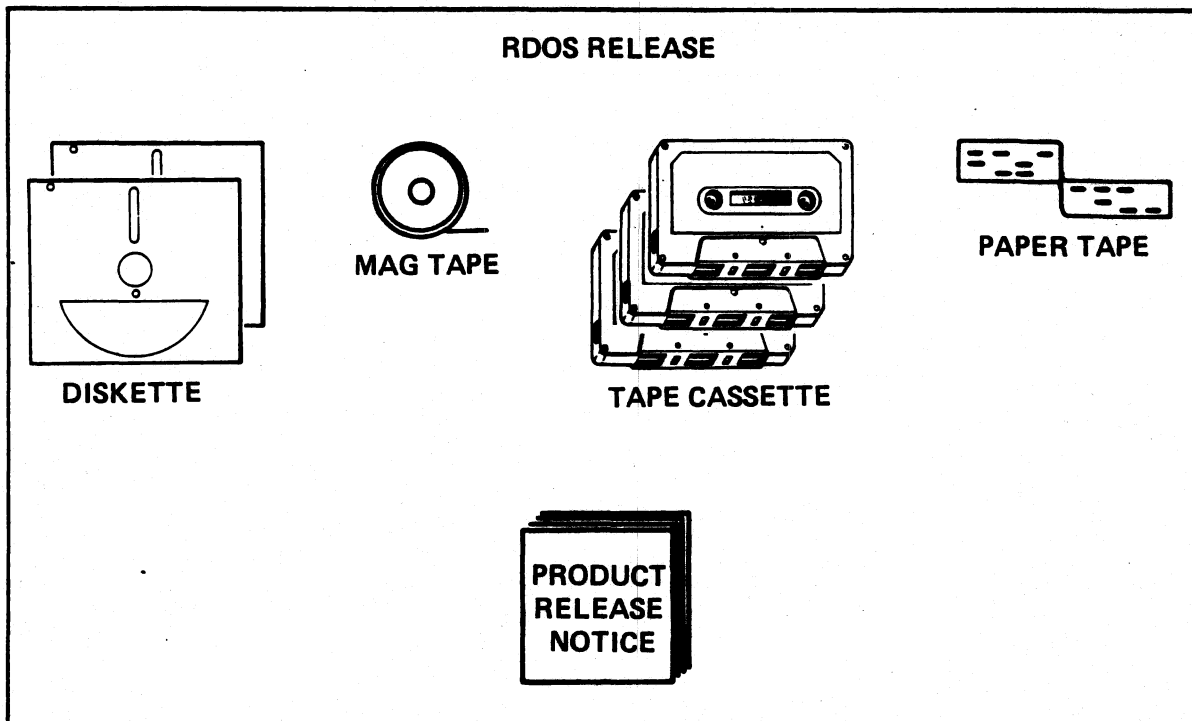

CS-00935

Figure 2.43 Software Release

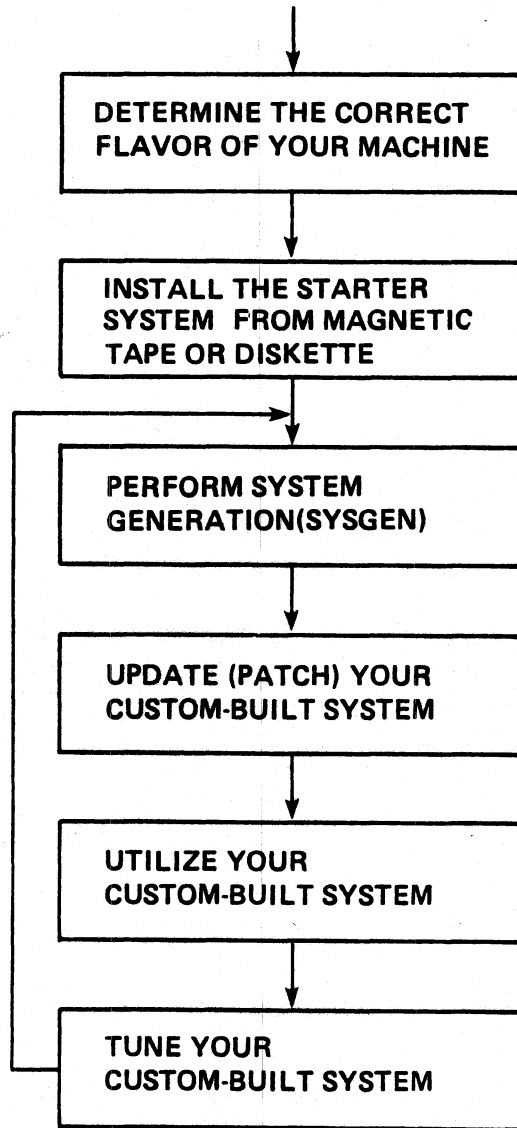

CS-00936

Figure 2.44 System Generation

Module 2

Quiz

Complete the following sentences:

1. The three main sections of a computer are _____, _____, _____.
2. The most fundamental logical unit of memory, called a _____, can have a value of either zero or one.
3. A _____ of memory contains 1,024 words.
4. _____ memory is capable of having information read out of it as well as having new information stored into it.
5. The _____ is a program that accepts command lines entered at the terminal and translates them into RDOS commands. It is your primary means of communicating with RDOS.
6. Concentric circles of data on a disc platter's surface are called _____.
7. When the _____ switch on the front panel is pushed, the CPU is stopped and all I/O devices are reset to a state where they will be ready to send or receive data.
8. You can tell that RDOS is ready to accept commands, because it outputs the prompt: _____.
9. _____ memory holds information magnetically for an indefinite period of time.
10. _____ memory stores information electrically, and the information is said to be volatile.
11. Eight sequential bits are referred to as a _____.
12. When you receive the RDOS software from Data General, you also receive a document called the _____, which contains the latest information of RDOS.
13. There are only two digits in the _____ number system: zero and one.
14. A _____ is a collection of information treated as a unit, or it is one of several devices for sending and receiving information.
15. _____ operation allows two different programs to reside in memory and appear to execute simultaneously.

16. The radix of the _____ number system is eight.
17. _____ memory contains permanently stored information that is unalterable.
18. The _____ is a 15-bit location in the CPU that holds the address of the next instruction to be executed.
19. The _____ of the CPU receives instructions that were fetched from memory by the control unit.
20. The _____ unit of the CPU performs arithmetic operations.
21. If a system has two controllers of the same type, the first controller is called the _____ and the second is called the _____.
22. RDOS comes in several _____ depending on the model of the computer on which it is to be installed.
23. An information transfer under _____ control moves a word or part of a word between an accumulator in the CPU and a register in the controller.
24. A hardware device called the _____ translates logical addresses into physical addresses and allows the maximum number of addressable storage locations to be increased.
25. Each word and byte has a unique number, called its _____, which identifies its location in memory.
26. _____ discs have one head for each track on a platter.
27. _____ discs use one head for each surface of a platter.
28. _____ programs are provided by Data General to aid the programmer in the development of his application programs.
29. An information transfer under _____ control moves a block of data between memory and a register in the controller.
30. Each controller is assigned a unique _____, which allows the CPU to differentiate between controllers.
31. Several interactive terminals may be connected to the I/O bus through a _____, which allows the different terminals to use a common communication line to the CPU.
32. Two bytes or 16 bits are referred to as a _____.
33. The procedure that allows you to generate an RDOS system tailored to your specific application is called _____.
34. The _____ unit of the CPU supervises all the activities of the computer under the direction of the stored program.
35. A set of _____ in the CPU provides an easily accessible, limited storage area for the temporary storage and manipulation of data.

36. A _____ is the interface between the computer and a peripheral device, interpreting commands from the computer to the device and passing information between them.
37. Data General computers use a code known as _____, which associates a unique numerical code with each of the 128 characters available to the user.
38. The rate at which information can be transferred over a communications line is called the _____.
39. RDOS provides a feature called _____, which enables RDOS to monitor its own efficiency and suggest adjustments that will produce a more efficient system.
40. _____ are the most commonly used mass storage devices that perform sequential access.
41. _____ are the most commonly used mass storage devices that allow direct access of addressable storage locations.
42. All three sections of a computer system are controlled and monitored with switches and lights located on the _____ or, alternatively, on some systems via a _____ console.
43. The _____ switch on the front panel controls power to the CPU.
44. When the _____ switch on the front panel is in the locked position, most of the front panel switches are disabled.
45. The front panel usually contains 16 _____ that are used to enter data or addresses into the system.
46. The _____ switch on the front panel causes the CPU to load a program into memory.

Check your answers with the correct answers given in *Appendix A: Quiz Answers*. Score one point for each correct answer. The maximum score is 46 points. Mastery level is 37 correct answers.

If you achieve mastery level, you may continue to either Module 3, which is optional, or Module 4. Module 3 is designed for students who want to practice concepts in subsequent modules and who have access to:

1. A scratch disc
2. A suitable NOVA or ECLIPSE computer
3. RDOS release tapes
4. Certain hardware information specified in Module 3.

If you do not achieve the mastery level of Module 2, review the material presented before continuing.

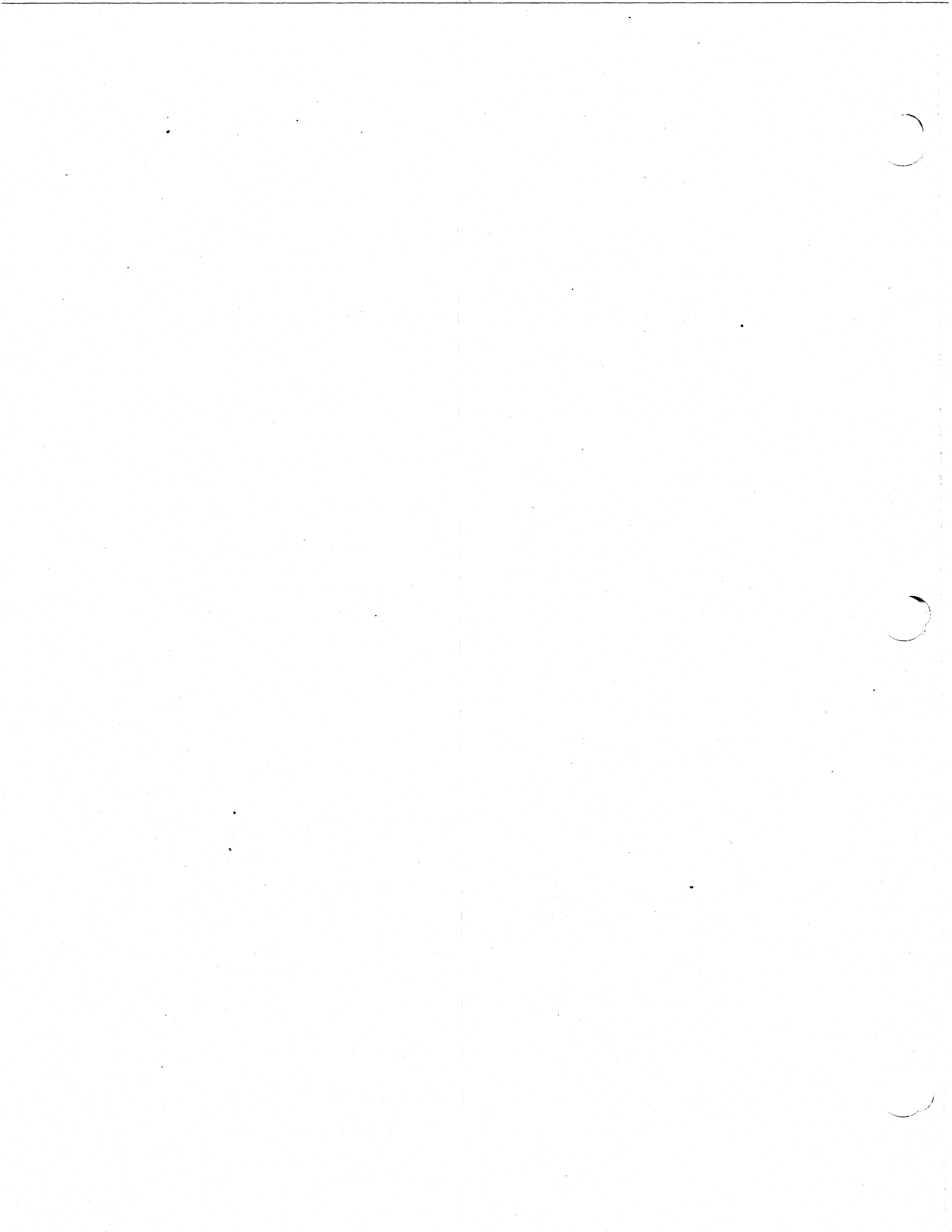

Module 3

Installation of a Student System

Introduction

This module is *optional*; you should complete it only if you wish to install an RDOS system on your own practice disc.

This module gives step-by-step instructions on how to install and generate a simple RDOS system that will run on most RDOS compatible hardware configurations. You can use this Student System to practice the concepts presented later in this course and to complete the Lab Exercises included at the end of each module.

The Student System you generate will probably be unsuitable for your actual applications; it is only for use with this course. This module does not attempt to show you how to generate a system for your "real-world" applications; this is covered in Module 11.

You can complete this module only if you have access to:

1. A suitable NOVA or ECLIPSE computer.
2. Your own formatted "scratch" disc. This must be a disc that does not contain any information that you need to save. **WARNING:** You will erase all data stored on this disc. All Data General discs supplied for RDOS systems are formatted.
3. RDOS release software (magnetic tape, diskettes).
4. Certain information about your hardware configuration listed in the section, *Information You Need to Know*, beginning on the next page.

As an alternative to completing this module, you may want to ask someone at your installation to generate a system for you. Or, if your system manager approves, you may want to use your installation's existing system.

Learning Objectives

Provided that you meet the above prerequisites, upon completion of this module you will be able to generate the RDOS Student System.

Information You Need to Know

To complete this module you must be able to answer all of the following applicable questions. You may need to do some detective work to find the answers. Get help from someone at your installation. Or, if no one is available and another system has already been generated, then a record of the steps taken at that time will be helpful. This record is called the dialog file created during SYSGEN (systemname.SG). Finally, your hardware sales receipt will also provide answers.

1. What kind of computer do you have?
 - a. NOVA
 - b. ECLIPSE
2. If you answered *b*, ECLIPSE, which type of processor?
 - a. C/300
 - b. C/350
 - c. S/250
 - d. S/200
 - e. Other
3. Do you have a hardware MAP? (MMPU on NOVA sales receipt)
 - a. Yes
 - b. No
4. If you answered *No* to Question 3, how many words of memory are in your system? (Between 16K and 32K)
_____K
5. Do you have a line printer?
 - a. Yes
 - b. No
6. If you answered *Yes* to Question 5, is it a data channel line printer?
 - a. Yes
 - b. No
7. What is the model number of the disc drive that holds your "scratch" disc?
 - a. 6001-6008 — Fixed-head NOVADISK (no cartridge), 0.13 to 2 megabyte (Mb)
 - b. 6063 — Fixed-head (no cartridge), 1 Mb
 - c. 6064 — Fixed-head (no cartridge), 2 Mb
 - d. 4047A, 4047B, 4237, 4238 — Front loading cartridge, 2.4 Mb
 - e. 6045 Series — Top-loading cartridge with fixed disc, 10 Mb
 - f. 4234A — Top-loading cartridge with fixed disc, 10 Mb
 - g. 6070 — Top-loading cartridge with fixed disc, 20 Mb

- h. 6099 — Sealed moving-head disc, 12.5 Mb
 - i. 4048A — Top-loading pack (6 platters), 6.2 Mb
 - j. 4057A — Top-loading pack (11 platters), 25 Mb
 - k. 4231A — Top-loading pack (11 platters), 92 Mb
 - l. 6060 — Top-loading pack (11 platters), 96 Mb
 - m. 6061 — Top-loading pack (11 platters), 190 Mb
 - n. 6067 — Top-loading pack (5 platters), 50 Mb
 - o. 6122 — Top-loading pack (11 platters), 277 Mb
8. To which controller is your disc drive connected?
- a. Primary
 - b. Secondary
9. If you answered either *b* or *c* to Question 2, and you answered either *b*, *c*, *l*, *m*, *n*, or *o* in Question 7, is your disc attached to a burst multiplexor channel?
- a. Yes
 - b. No
10. If you received your RDOS software on diskette, does the diskette drive share a controller with your disc drive? (Only Models 6098/6099, 6045, or 4234 discs can share a controller with a diskette.)
- a. Yes
 - b. No

If you meet all the prerequisites, you can generate the practice operating system called STUDENTSYS by completing the step-by-step instructions in this module. If you do not meet the prerequisites, skip this module and go to Module 4.

STUDENTSYS is a simple system that runs on most RDOS compatible hardware configurations. This system does not support multi-user Extended BASIC, nor does it support INFOS. Despite these limitations it provides a very useful teaching mechanism and is recommended as an optional module.

There is no audiocassette tape for this module. Follow the instructions given in this Student Guide. If you are to be successful, you must read the directions carefully and follow the instructions exactly.

In the process of installing STUDENTSYS, you will invoke programs that ask you questions. Often your response to these questions will require you to type in certain information and then press the carriage return key. For example, one program asks:

DISK UNIT?

You might respond by typing:

DP0)

The Student Guide uses a curved arrow `)` to indicate a carriage return. The `)` terminates your response. It tells the program that you have finished entering the information requested.

If you make a typing mistake, but haven't pressed `)`, you can use the DEL or RUBOUT key to remove characters sequentially from right to left. Depending on your type of console and the program, the characters will disappear one-by-one, or an underscore (`_`) or backarrow (`←`) will appear for each character erased. For example, suppose you type:

DB0

and you realize your mistake *before* you press `)`. You can remove the 0 and the B by pressing DEL or RUBOUT twice, then typing `P0)`, to give the program the correct response.

However, if you make a mistake and you realize your error *after* you press `)`, you must stop execution of the program. To do this, hold down the CTRL key and simultaneously press the letter A key. This stops the program but does not correct your error. If this happens, or if you get an unexpected error message from one of the programs, it is best to repeat the installation procedure from the very beginning.

There are three major steps involved in generating STUDENTSYS:

1. Determine the correct RDOS flavor for your machine.
2. Install the RDOS Starter System.
3. Generate STUDENTSYS.

Step 1:

Find the RDOS release software that applies to your system. This is distributed by Data General on either magnetic tape or diskettes. RDOS flavors are:

URDOS Unmapped NOVA
 MRDOS Mapped NOVA
 NRDOS Mapped NOVA 3 or NOVA 4
 BRDOS Unmapped ECLIPSE
 ARDOS Mapped ECLIPSE (S/200 or C/300)
 ZRDOS Mapped ECLIPSE (any other ECLIPSE)

Step 2:

- a. Power up your equipment.
- b. Load your "scratch" disc into drive 0, wait for READY.
- c. Turn all your consoles online and press ALPHA LOCK.
- d. If you received your RDOS release software on magnetic tape, then perform the steps described in the section, *Loading Your RDOS Starter System from Magnetic Tape*, which is presented in Module 11 of this Student Guide (beginning on page 11-18). Do not perform Steps 16 and 32. Then return to Module 3.

If you received your RDOS release software on diskette, then perform the steps described in the section, *Loading Your RDOS Starter System from Diskette*, which is presented in Module 11 of this Student Guide (beginning on page 11-29). Do not perform Steps 22 and 45. Then return to Module 3.

NOTE: You may not understand all the commands and explanations in these sections. Don't be concerned; when you are instructed to enter a fixed command, type it exactly as shown. Sometimes, however, you are given a choice of commands. In these cases, you must make the correct choice based on your answers to the questions in the preceding section, "Information You Need to Know."

Step 3:

Perform the steps described in the section, *Generating STUDENTSYS*, which is presented in this module beginning on the next page.

NOTE: You will not update STUDENTSYS. This will be covered in Module 11.

Generating STUDENTSYS

This section assumes that you have already performed the steps described in Module 11 under *Loading Your RDOS Starter System from Magnetic Tape*, or *Loading Your RDOS Starter System from Diskette*, depending on the medium of your release software.

In this section, you will invoke a program that asks you questions about your hardware configuration and software requirements. In many cases, you will be told exactly what to enter in response to these questions. In other cases, you will have to decide based on your answers to the questions in the section, *Information You Need to Know*.

To begin, you need to start up the RDOS Starter System that you just finished installing. (You may have already performed Steps 1 and 2.)

1. Power up all equipment if it is not already on. Put the system console and line printer (if any) ON LINE. Stop the computer, either by pressing the keyboard BREAK key (programmed consoles) or the front panel STOP switch (hardware data switches).
2. Insert the disc pack or cartridge into drive 0 (if applicable). Flip the LOAD/RUN switch to RUN and wait for the READY light.
3. Program load your computer from disc. Do either *a*, *b*, or *c*.
 - a. If you have a programmed console, type 1000nnL on the system console. See the second column of Table 3.A for nn. For example, if you have a Model 6060, type 100027L.
 - b. If you have hardware data switches and automatic program load hardware, set the data switches to 1000nn (see Table 3.A for nn). Lift RESET, then PROGRAM LOAD. Go to Step 4. For example, if you have a Model 6060, lift switches 0, 11, 13, 14, 15 (all others down). Lift RESET, then PROGRAM LOAD.
 - c. If you do not have automatic program load hardware:
 - Set the data switches to 000376g (switches 8 through 14 up, others down); then lift EXAMINE.
 - Set the data switches to 0601nn. (See Table 3.A for nn.) Lift DEPOSIT.
 - Set the data switches to 000377g (switches 8 through 15 up, others down). Then depress DEPOSIT NEXT.
 - Set the data switches to 000376g (put down switch 15) and lift RESET, then START.

Table 3.A Disc Controller Device Codes

Disc Type	nn = (octal)	With hardware data switches, set these switches up (others down).
Fixed-Head Model 6063-6064 Controller 1 Controller 2 Model 6001-6008 Controller 1 Controller 2	26 66 20 60	0, 11, 13, 14 0, 10, 11, 13, 14 0, 11 0, 10, 11
Moving-Head Model 6060-6061, 6067, 6122 Controller 1 Controller 2 Other Discs Controller 1 Controller 2	27 67 33 73	0, 11, 13, 14, 15 0, 10, 11, 13, 14, 15 0, 11, 12, 14, 15 0, 10, 11, 12, 14, 15

4. The console displays:

FILENAME?

If you have an upper/lowercase console, hold down the SHIFT key, then type the name of the system or program you want to execute. For your first system, this is:

BOOTSYS } (if you loaded the software from mag tape), or
FBOOTSYS } (if you loaded the software from diskette).

This brings the RDOS Starter System into memory and executes it.

5. RDOS requests the current date (month, day, and year) and time (hours in 24, minutes, and seconds). Provide these in the format of the following example:

NOVA RDOS REV xx (xx = revision number)
DATE (M/D/Y)? 1 10 79 }
TIME (H:M:S)? 16 53 }
R

System Generation

6. The R prompt indicates that RDOS is in control and is ready to accept commands. Type this command:

```
DIR SYSGEN)
R
```

Now you are ready to generate STUDENTSYS. The system generation command is:

```
{BSYSGEN
 NSYSGEN } STUDENTSYS.<SV/S SG/V LM/L>
SYSGEN
```

Only enter one of the names in braces:

BSYSGEN for an ECLIPSE system without INFOS
 NSYSGEN for a Mapped NOVA 3 or NOVA 4 system
 SYSGEN for all other NOVA systems.

All the answers to the system generation program are numeric and in decimal. In some questions, if you press the RETURN or CR key (), the program accepts zero as an answer. Sometimes you will be instructed to press RETURN when you know that a correct answer could be more than zero. For example, the program asks how many papertape readers you have. You may be instructed to answer zero, but your system may, in fact, include some papertape readers. In this module, answer the questions as recommended. STUDENTSYS is simply unaware of some devices, and you will be unable to use them until you generate your "real" system in Module 11.

- *MAPPED SYSTEM? ("0" = NO "1" = YES)*

Answer 1) to generate a mapped system. If you answer 0) SYSGEN skips to the "CORE STORAGE" question. For a mapped NOVA system, SYSGEN skips to the "NUMBER OF CHANNELS BACKGROUND" question.

- *S/250 OR C/350 TYPE PROCESSOR? ("0" = NO "1" = YES)*

Answer 1) to generate a system for an S/250 or C/350. SYSGEN then asks the next two questions. Answer 0) to generate a system for C/150, S/200 or S/230, or C/300 or C/330. If you answer 0) , SYSGEN skips the next two questions.

- *BURST MULTIPLEXOR CHANNEL (BMC) ("0" = NO "1" = YES)*

A burst multiplexor is a device for handling disc data; up to four Model 6060/6061-6067 or 6063/6064 discs can be attached to it. It is available as an option with certain mapped ECLIPSE machines. Answer 1) if you have one or more Model 6060 series or 6063 series discs attached to a burst multiplexor; otherwise answer 0) . If you answer 1) , SYSGEN will later ask you about discs wired to the BMC.

- **ARRAY PROCESSOR? ("0" = NO "1" = YES)**

Press the RETURN or CR key (↵).

- **S/200 OR C/300 MAP? ("0" = NO "1" = YES)**

Answer 1 ↵ to generate a system for an ECLIPSE S/200 or C/300 processor.
Answer 0 ↵ for a C/150, S/130, S/230, or C/330. If you answer 0 ↵, SYSGEN goes *back* to the previous question, "ARRAY PROCESSOR?"

- **MAXIMUM NUMBER OF CHANNELS BACKGROUND WILL USE (1-255)**

Type 64 ↵ .

- **MAXIMUM NUMBER OF CHANNELS FOREGROUND WILL USE (0-255)**

Type 64 ↵ .

If you specify an unmapped system, SYSGEN asks:

- **CORE STORAGE (IN THOUSANDS OF WORDS, 16-32)**

Type the amount of memory storage your system has, in multiples of 1024 words; e.g., type 20 if you have 20,480 words.

- **NUMBER OF NOVADISK CONTROLLERS (0-2)**

There are two types of fixed-head discs. A NOVADISK is a Model 6001-6008 fixed-head disc; the other is the Model 6063/6064, which SYSGEN asks about next. Answer with the number of 6001-6008 discs you want this system to support.

If you have 0 or 2 of these discs, SYSGEN skips the next question.

- **DEVICE PRIMARY ("0") OR SECONDARY ("1")?**

Answer 0 ↵ if your 6001-6008 disc is wired to the first device code; answer 1 ↵ for the second device code. The primary disc has device code 20g and disc-identifying mnemonic DK0; the secondary disc has device code 60g and mnemonic DK1.

- **NUMBER OF 6063/6064 DISK CONTROLLERS (0-2)**

The 6063/6064 is the other, newer type of fixed-head disc. Answer 0 ↵, 1 ↵, or 2 ↵, depending on the number of *controllers* you have for 6063/6064 drives. Each controller can handle up to four drives.

If you have one 6063/6064 controller, SYSGEN asks:

- **DEVICE PRIMARY ("0") OR SECONDARY ("1")?**

Answer 0 ↵ if your 6063/6064 controller is connected to the first device code; answer 1 ↵ for the second device code. The first controller has device code 26g; it controls drives named DS0, DS1, DS2, and DS3. The second controller has device code 66g; it controls drives named DS4, DS5, DS6, and DS7.

- **NUMBER OF DEVICES FOR CONTROLLER #1 (1-4)**

Answer with the number of disc drives connected to the first controller.

If you specified two 6063/6064 controllers, SYSGEN repeats this question for the second controller.

- **NUMBER OF 6060/6061/6067/6122 DISK CONTROLLERS (0-2)**

Answer 0), 1), or 2) depending on the number of controllers you have for 6060/6061/6067/6122 series disc drive consoles. These drives hold multiple-platter disc packs. The primary controller has device code 27g and controls consoles DZ0, DZ1, DZ2, and DZ3; the secondary controller has device code 67g and controls consoles DZ4, DZ5, DZ6, and DZ7.

If you answer 1), SYSGEN wants to know:

- **DEVICE PRIMARY ("0") OR SECONDARY ("1")?**

Answer 0) if your 6060/6061/6067/6122 controller is wired to the first device code (27g); answer 1) for the second device code (67g).

- **NUMBER OF DEVICES FOR CONTROLLER #1 (1-4)**

Respond with the number of 6060/6061/6067/6122 disc consoles connected to the first controller.

If you specified two 6060/6061/6067/6122 controllers, SYSGEN repeats this question for the second controller.

- **NUMBER OF OTHER TYPES OF MOVING-HEAD DISK CONTROLLERS (0-2)**

This question covers the remaining models of discs. It includes all sealed moving-head discs, top-loading disc drives, and diskettes. Be sure to specify the number of non-6060 series controllers in the system, not the total of moving-head discs.

If you have no other type of moving-head disc, SYSGEN skips the next five questions. If you answer 1), SYSGEN requests:

- **DEVICE PRIMARY ("0") OR SECONDARY ("1")?**

Generally, your moving-head disc controller will be primary, so answer 0). If you know for certain that it is connected to the second controller, answer 1). The primary moving-head disc controller has I/O device code 33g and the disc-identifying mnemonics DP0, DP1, DP2, and DP3 for drives 1 through 4, respectively. The secondary controller has device code 73g and mnemonics DP4, DP5, DP6, and DP7 for the second set of devices 1 through 4, respectively.

- **NUMBER OF DEVICES FOR CONTROLLER #1 (1-4)**

Each sealed moving-head disc, each dual-platter top loader disc subsystem and each diskette drive counts as one device.

Give the number of drives connected to the first controller.

- **TOP LOADER(S)? ("0" = NO "1" = YES)**

If you have Model 6045, 6070, or 4234A top-loading cartridge disc drives connected to the first controller, answer 1; otherwise answer 0. These drives include a built-in nonremovable disc, and your answer identifies the extra storage to SYSGEN. The removable disc has mnemonics DP0, DP1, DP2 or DP3; the fixed disc has the same mnemonic but with the suffix F; i.e., DP0F through DP3F.

If you specified two moving-head disc controllers, SYSGEN asks the two questions:

- **NUMBER OF DEVICES FOR CONTROLLER #2 (1-4)**
- **TOP LOADER(S) ("0" = NO "1" = YES)**

To which you respond as you did to the questions about the first controller. The second "other" type of disc controller has device code 73g. For the second controller, the removable disc has mnemonics DP4, DP5, DP6, or DP7; the fixed disc (if any) has the same mnemonics, but with the F suffix: DP4F through DP7F.

- **ENTER BAD BLOCK POOL SIZE IN BLOCKS (0-512)**

Enter the same value DKINIT assigned to the disc when you defaulted the DKINIT "DEFAULT REMAP AREA SIZE?" question in Module 11. If you don't remember the DEFAULT size and DKINIT ran all patterns without an error, try 12 for each disc unless you have large discs. With one or more large discs (Model 6060/6061/6067/6122), try 60.

- **DUAL PROCESSORS (IPB)? ("0" = NO "1" = YES)**

Press the RETURN or CR key ().

- **ENTER NUMBER OF STACKS (1-10)**

Type 6.

- **ENTER NUMBER OF EXTRA CELLS (0-64)**

Type 8.

- **TUNING ("0" = NO "1" = YES)**

Type 1.

- **SHALL TUNING BE WITH ("1") OR WITHOUT ("0") OVERLAY REPORT?**

Type 1.

- **ENTER NUMBER OF EXTRA BUFFERS REQUIRED (0-63)**

Memory Size	Type In
20K	0
24K	4
32K or more	8

- **MAXIMUM NUMBER OF SUBDIRECTORIES/SUBPARTITIONS ACCESSIBLE AT ONE TIME (0-64)**

Type 12.

- **ENTER NUMBER OF CONTROLLERS FOR MTA (0-2)**
If you have one or more magnetic tape transports, type 1). You are only able to use one magnetic tape transport with STUDENTSYS. It is the unit with the select switch on 0. If you don't have any magnetic tape transports, type 0).
If you have one magnetic tape controller, SYSGEN asks:
- **DEVICE PRIMARY ("0") OR SECONDARY ("1")?**
Type 0) (on most systems).
- **ENTER NUMBER OF CONTROLLERS FOR CTA (0-2)**
Press the RETURN or CR key ().
- **AUTO-RESTART ON POWER FAIL? ("0" = NO "1" = YES)**
Press the RETURN or CR key ().
- **OPERATOR MESSAGES ("0" = NO "1" = YES)**
Press the RETURN or CR key ().
- **RTC? ("0" = NO "1" = YES)**
Type 1).
- **DEVICE PRIMARY ("0") OR SECONDARY ("1")?**
Type 0).
- **ENTER RTC FREQ (1 = 10HZ, 2 = 50HZ, 3 = 60HZ, 4 = 100HZ, 5 = 1000HZ)**
Type 1).
- **ENTER NUMBER OF PTR (0-2)**
Press the RETURN or CR key ().
- **ENTER NUMBER OF PTP (0-2)**
Press the RETURN or CR key ().
- **ENTER NUMBER OF LPT (0-2)**
If you have one or two line printers, type 1). You are only able to use one line printer with STUDENTSYS. Otherwise, type 0).
- **ENTER COLUMN SIZE DEVICE #1 (80 OR 132)**
If the paper in your line printer is about 10-in. wide, enter 80). If the paper is about 15-in. wide, enter 132).
- **DATA CHANNEL LINE PRINTER? ("0" = NO "1" = YES)**
If your line printer is a data channel printer, type 1). Otherwise, type 0).

- **ENTER NUMBER OF CDR (0-2)**
Press the RETURN or CR key (↵).
- **ENTER NUMBER OF PLT (0-2)**
Press the RETURN or CR key (↵).
- **ENTER NUMBER OF MCA (0-2)**
Press the RETURN or CR key (↵).
- **QTY? ("0" = NO "1" = YES)**
Press the RETURN or CR key (↵).
- **ULM? ("0" = NO "1" = YES)**
Press the RETURN or CR key (↵).
- **ALM? ("0" = NO "1" = YES)**
Press the RETURN or CR key (↵).
- **SECOND TTY? ("0" = NO "1" = YES)**
If you have two or more interactive terminals, type 1 (this will work on most systems). Otherwise, if you only have one terminal, type 0.
- **CORE DUMP FACILITY? ("0" = NO "1" = LPT "2" = MTA "3" = 6030 "4" = 6097)**

If the system comes down unexpectedly, the core dump program can copy the computer's memory state to whatever device you specify. You can choose only one answer. Type 0 if you don't want the core dump; 1 to dump to the line printer; 2 to dump to mag tape drive 3 (the dump program gives you a chance to dial 3 before you dump); 3 to dump to single-density diskette 3 (the dump program gives you a chance to dial 3 before you dump); or 4 to dump to double-density diskette.

If you answer 2, the program asks whether the device is primary or secondary; answer 0.

If you answer 3 or 4 to the core dump question, the program asks whether the dump should go to the primary or secondary controller. Answer according to your system.

If you answer 4 to the core dump question, the program asks for the unit number that will receive the core dump. Answer according to your system.

The core dump question is the last question in the system generation dialog. Now the program is creating STUDENTSYS. The entire process takes a few minutes, so don't be alarmed by the delay. Soon, the program will return control to the RDOS Starter System, which issues the prompt:

R

Now type:

DIR %MDIR%)

R

LINK STUDENTSYS.SV SYSGEN:STUDENTSYS.SV)

R

LINK STUDENTSYS.OL SYSGEN:STUDENTSYS.OL)

R

At this point you are still running under the starter system. In the next module, Module 4, you will learn how to start up STUDENTSYS.

The last step in this module is to shut down the starter system. Type:

RELEASE %MDIR%)

MASTER DEVICE RELEASED

This concludes Module 3. Continue now to Module 4, *System Start Up and Shut Down*.

Module 4

System Start Up and Shut Down

Introduction

This module describes the steps necessary to properly “start up” and “shut down” an RDOS system on a NOVA or ECLIPSE computer.

Learning Objectives

Upon successful completion of this module you will be able to:

1. List the three major steps involved in bringing up an RDOS system.
2. Given an example of a typical configuration, show the steps that are necessary to perform an automatic program load.
3. Identify the meaning of the following terms:
 - System Console
 - Bootstrap Loader
 - Alpha Lock Key
 - Bootstrapping
4. Show the command that will bring RDOS down correctly.

Resources

1. RDOS Student Guide, Module 4
2. Audiocassette tape for Module 4
3. *DGC Disc Drives — Operator's Manual*

Module Outline

1. The Three Steps for Starting Up RDOS
 - a. Powering Up the Equipment
 - b. Loading the Disc
 - c. Bootstrapping
 - Automatic Program Load
 - Loading Your RDOS System
2. Shutting Down RDOS
 - a. Release Command
3. Module Quiz

Directions

Turn to Figure 4.1 and listen to the audiocassette tape for Module 4.

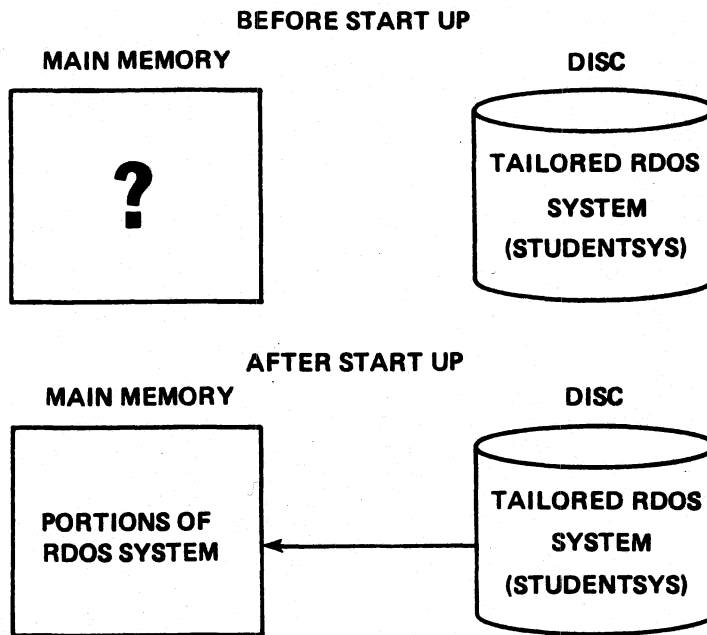

CS-00937

Figure 4.1 The Goal of Starting Up the System

Starting Up RDOS

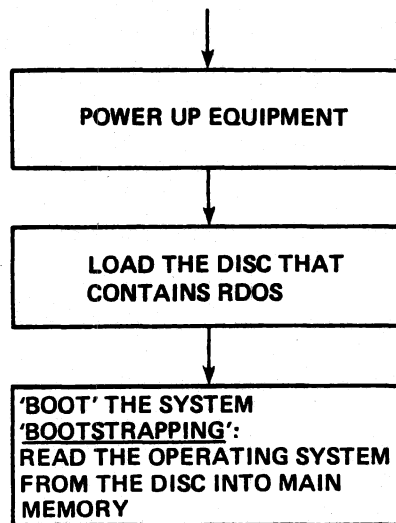

CS-00938

Figure 4.2 Three Major Steps Involved in Bringing Up the System

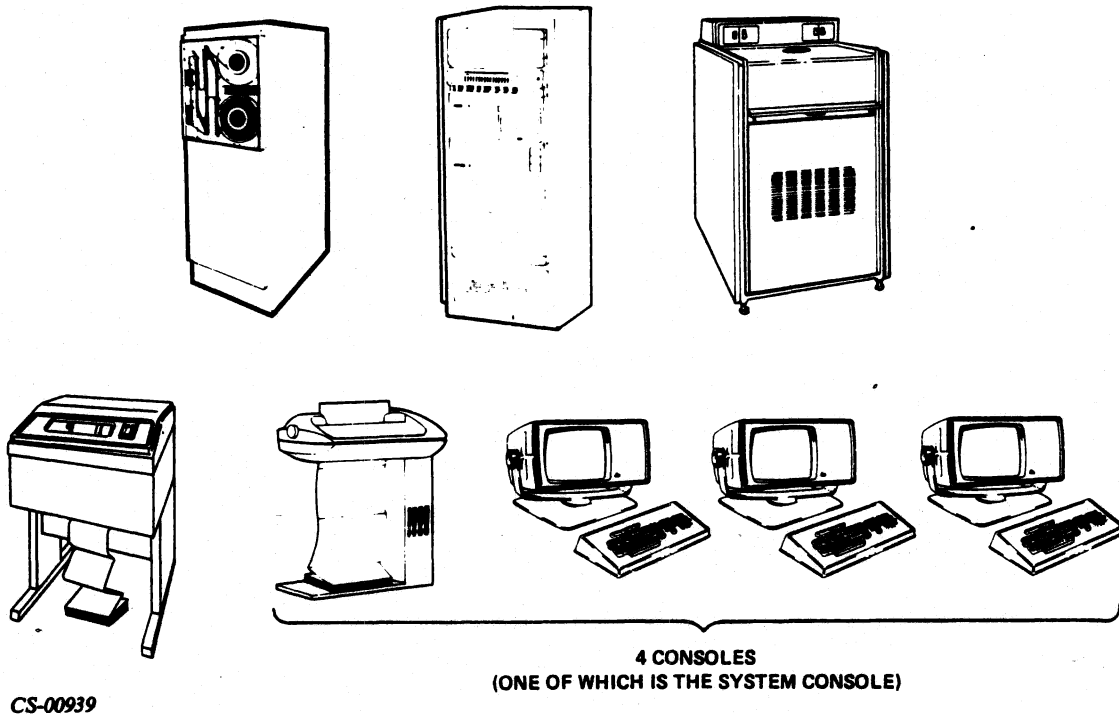

Figure 4.3 Typical Configuration

- System Console — Bootstrapping causes RDOS to be activated on this console (also called “master” console or “background” console).

Preliminary Steps Prior to Bootstrapping

Power Up the Equipment

1. CPU
 - a. Front Panel: Power ON/OFF, switch to ON position
(Review Figure 2.37 if necessary)
2. Terminals (Consoles)
 - a. Power ON
 - b. Mode switch to ON LINE
 - c. If upper- and lower-case, press ALPHA LOCK
(Review Module 2 discussion on terminals)
3. Line Printer
 - a. Power ON
 - b. Mode switch to ON LINE

Load the Disc

1. The Disc
 - a. Load the disc — wait for READY light.
 - b. If the disc has a thumbwheel, unit-number selector, make sure it is set to 0.
(Review *DGC Disc Drives — Operator's Manual* or Figure 2.34 as necessary.)

Automatic Program Load

- Q. How do you get a program into memory?
- A. By another program that already resides in memory.
- Q. But, how do you get *that* program into memory?
- A. Automatic Program Load:
- A program called the **Bootstrap Loader** is supplied in Read-Only Memory (ROM). The program can be automatically loaded into memory. Once it is in memory, it begins a sequence of operations that load successively more powerful programs until RDOS is loaded.
- Q. How do you initiate automatic program load?
- A. If your system console is a **Programmed Console**, follow the directions in the sections *Automatic Program Load with Programmed Console* and *Bringing Up Your RDOS System*.

If your system console is *not* a programmed console, then follow the directions in the sections *Automatic Program Load with Hardware Data Switches* and *Bringing Up Your RDOS System*.

Automatic Program Load with Programmed Console

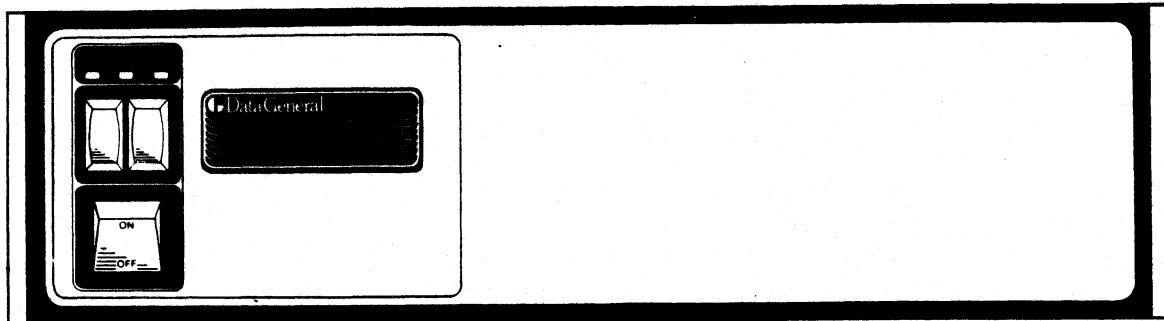

CS-00940

Figure 4.4 Front Panel — NOVA 4

If you have a programmed console, it should display some numbers followed by an exclamation point.

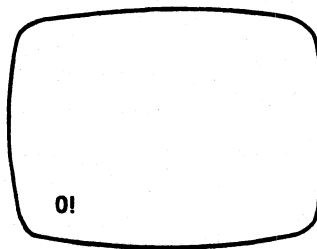

CS-00941

Figure 4.5 Programmed Console

1. Check the table of disc controller device codes to find the octal device code, which corresponds to the disc drive that contains your RDOS system.

Table 4.A Disc Controller Device Codes

Disc Type	nn = (octal)
Fixed-Head	
Model 6063-6064	
Controller 1	26
Controller 2	66
Model 6001-6008	
Controller 1	20
Controller 2	60
Moving-Head	
Model 6060-6061, 6067, 6122	
Controller 1	27
Controller 2	67
All Other Discs	
Controller 1	33
Controller 2	73

2. Type in: 1000nnL

Where nn is the octal device code of the disc drive in your system (i.e., for Model 6060 on Controller 1, type 100027L).

3. Read the section, *Bringing Up Your RDOS System*.

Automatic Program Load with Hardware Data Switches

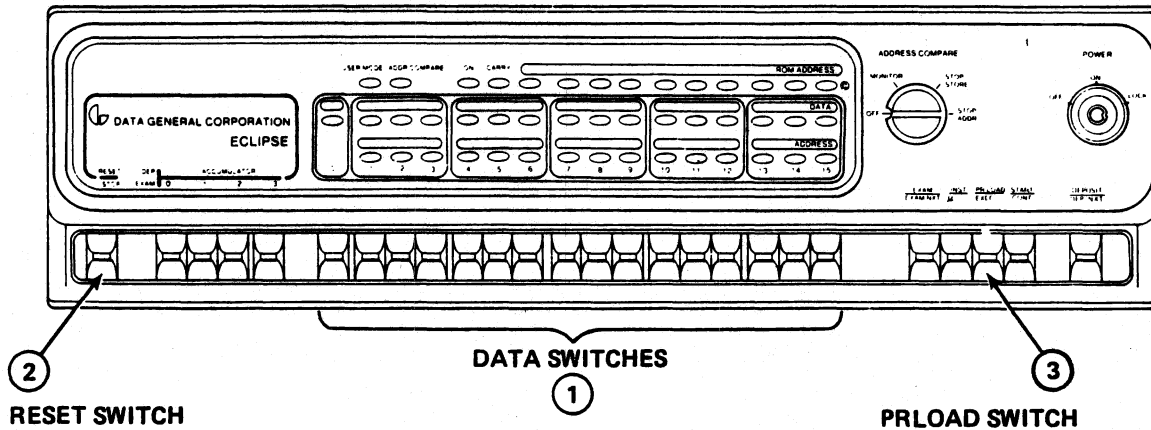

Figure 4.6 Front Panel — ECLIPSE

1. Check the table of disc controller device codes to find the disc drive model number that contains your RDOS system. Set the hardware data switches as shown in the right-hand column of Table 4.B (i.e., Model 6060 Controller 1: Switches 0, 11, 13, 14, 15 are up; the others down).

Table 4.B Disc Controller Device Codes

Disc Type	nn = (octal)	With hardware data switches, set these switches up (others down).
Fixed-Head		
Model 6063-6064		
Controller 1	26	0, 11, 13, 14
Controller 2	66	0, 10, 11, 13, 14
Model 6001-6008		
Controller 1	20	0, 11
Controller 2	60	0, 10, 11
Moving-Head		
Model 6060-6061, 6067, 6122		
Controller 1	27	0, 11, 13, 14, 15
Controller 2	67	0, 10, 11, 13, 14, 15
All Other Discs		
Controller 1	33	0, 11, 12, 14, 15
Controller 2	73	0, 10, 11, 12, 14, 15

2. Lift the RESET switch up.
3. Lift the PRLOAD switch up.
4. Read the section, *Bringing Up Your RDOS System*.

Bringing Up Your RDOS System

1. For either type of configuration the system console will display:

FILENAME?

2. Answer by typing the name of your tailored RDOS system. For example, the name of the system that is generated in Module 3 is STUDENTSYS. (Remember ALPHA LOCK should be on.)

FILENAME? STUDENTSYS

3. If the RDOS system you specify is found, it will display:

FILENAME? STUDENTSYS

RDOS REV x.xx (x.xx is the revision number)

DATE (M/D/Y)?

4. Enter the current date in the correct format:

FILENAME? STUDENTSYS

RDOS REV x.xx

DATE (M/D/Y)? 4 2 79

5. RDOS asks for the current time. Enter the time in 24-hr format:

FILENAME? STUDENTSYS

RDOS REV x.xx

DATE (M/D/Y)? 4 2 79

TIME (H:M:S)? 13 10 (Hours in 24)

6. The RDOS ready prompt R:

FILENAME? STUDENTSYS

RDOS REV x.xx

DATE (M/D/Y)? 4 2 79

TIME (H:M:S)? 13 10

R

Shutting Down RDOS

To bring down RDOS:

1. Enter *RELEASE %MDIR%*
2. And RDOS responds *MASTER DEVICE RELEASED*
3. Remove disc (see *DGC Disc Drives — Operator's Manual*)
4. Power down the equipment.

Module 4

Quiz

1. List the three major steps necessary to start up an RDOS system.

- a. _____
 b. _____
 c. _____

Complete the following sentences:

2. The procedure that reads RDOS from disc and loads it into memory is called _____.
3. When RDOS is started up, it is activated at the _____ console.
4. The program, supplied in ROM, which begins a sequence of operations that load successively more powerful programs, is called the _____.
5. When you press _____ on a terminal, all the letters that you type are entered in uppercase. This is the only way you can enter information when you are starting up the system.
6. The command used to shut down an RDOS system is _____.
7. Given the following information, answer either Part A or B.

Imagine that an RDOS system called "QUIZSYS" has been previously generated. This system resides on a disc that has been loaded in a Model 6050 Disc Drive on Controller 1.

Table 4.C Disc Controller Device Codes

Disc Type	nn = (octal)	With hardware data switches, set these switches up (others down).
Fixed-Head		
Model 6063-6064		
Controller 1	26	0, 11, 13, 14
Controller 2	66	0, 10, 11, 13, 14
Model 6001-6008		
Controller 1	20	0, 11
Controller 2	60	0, 10, 11
Moving-Head		
Model 6060-6061, 6067, 6122		
Controller 1	27	0, 11, 13, 14, 15
Controller 2	67	0, 10, 11, 13, 14, 15
All Other Discs		
Controller 1	33	0, 11, 12, 14, 15
Controller 2	73	0, 10, 11, 12, 14, 15

A. Hardware Data Switches

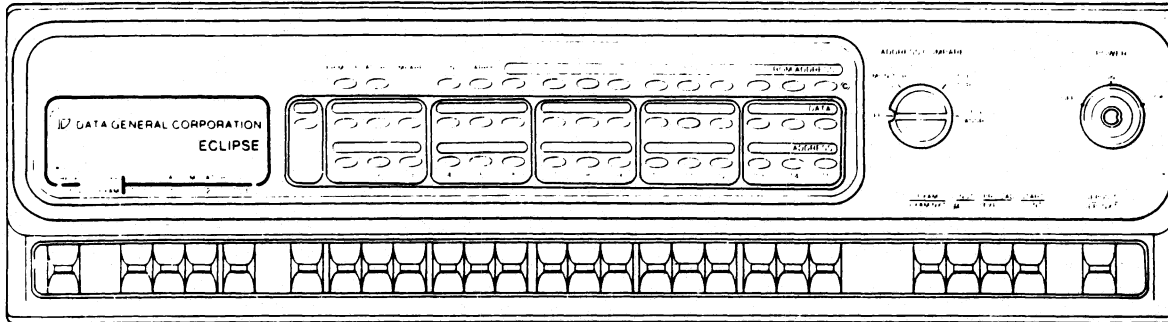

CS-00943

Figure 4.7 Front Panel — ECLIPSE

Indicate on the front panel above:

1. Which data switches should be in the up position.
2. Which other two switches must be lifted, and in what order to perform automatic program load.

What should you enter in response to the prompt:

FILENAME? _____

B. Programmed Console

Indicate what must be entered to perform an automatic program load:

! _____

What should you enter in response to the prompt:

FILENAME? _____

Check your answers with those given in *Appendix A: Quiz Answers*. Score one point for each correct answer. The maximum score is 8 points. Mastery level is 7 points. If you achieve mastery level, you may continue on to Module 5. Otherwise, review the material presented in this module before continuing.

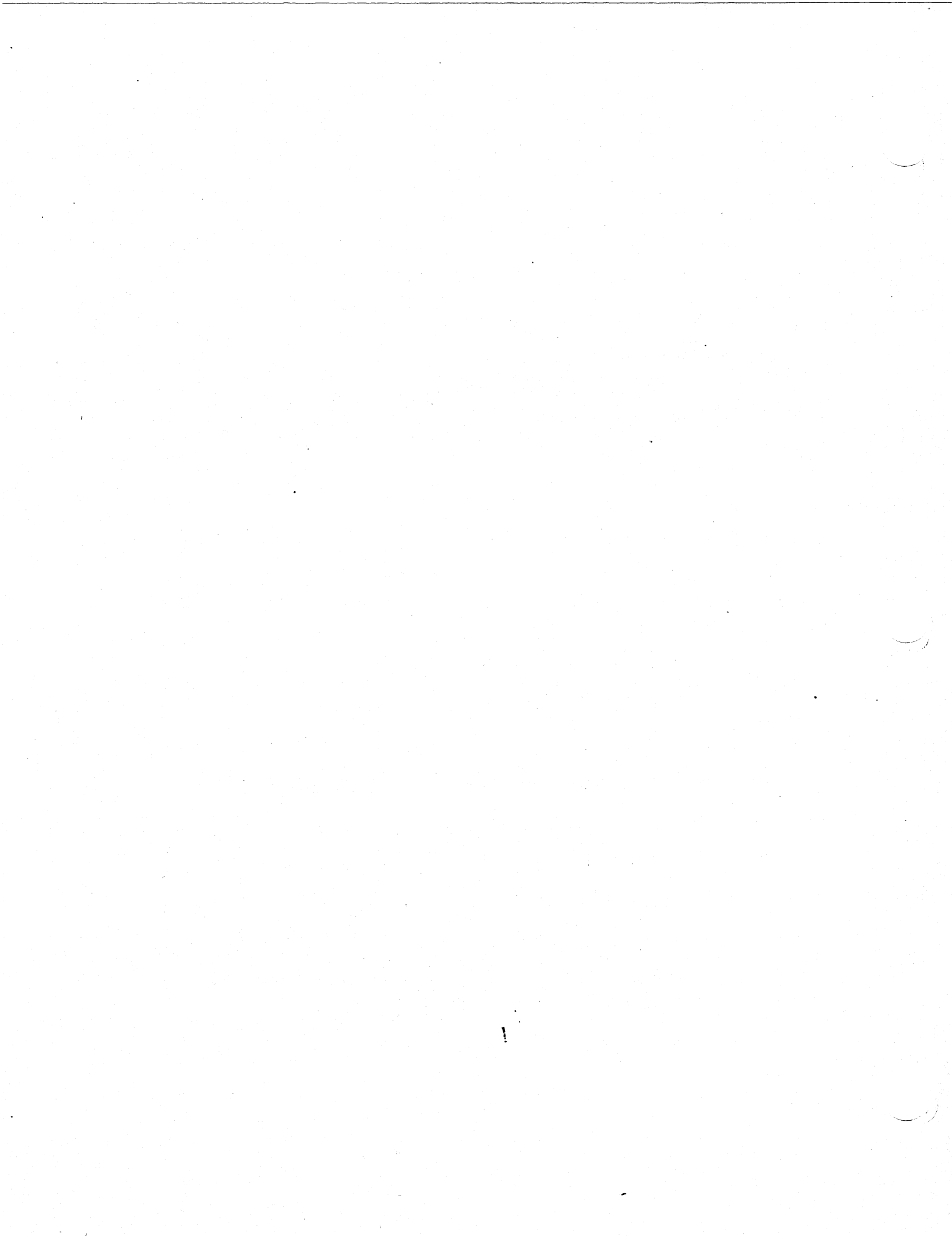

Module 5

Command Line Interpreter

Introduction

The Command Line Interpreter (CLI) is a program supplied by Data General that acts as an interface between you and RDOS. It accepts commands that you enter at a terminal and translates them into RDOS operations. You can perform a wide variety of tasks with the CLI. This module is primarily concerned with the CLI's general features, however, some specific, simple commands are discussed. How the CLI responds to errors, correction methods, and advanced CLI features that can minimize typing and provide additional power and control over RDOS are also discussed.

Learning Objectives

Upon successful completion of this module you will be able to:

1. Predict the consequences of example dialog between the CLI and a system user.
2. Match the following CLI commands, punctuation, and control sequences with the functions they perform:

Table 5.A

Command	Punctuation	Control Sequence
GTOD	Delete or Rubout	CTRL-A
STOD	Backslash (\) or Shift L	CTRL-S
SDAY	Semicolon (;)	CTRL-Q
GSYS	Up Arrow (↑)	CTRL-Z
CREATE	Parentheses ()	CTRL-L
XFER	Angle Brackets < >	
DELETE	Commercial at sign (@)	
TYPE	.MC extension	
PRINT	Carriage Return ()	
LOG		
ENDLOG		
MESSAGE		

3. Identify the meaning of the following terms:

Argument
Local Switch
Global Switch
LOG.CM
CLI Variables
Macro
Indirect File

Resources

1. RDOS Student Guide, Module 5
2. Audiocassette tape for Module 5
3. *RDOS/DOS User's Handbook*

Module Outline

1. Command Line Format
2. Some CLI Commands
3. Recording CLI Dialog
4. Error Handling
5. Control Sequences
6. Advanced Features
7. CLI Variables
8. Indirect Files and Macros
9. Lab Exercise
10. Module Quiz

Directions

Turn to Figure 5.1 and listen to the audiocassette tape for Module 5.

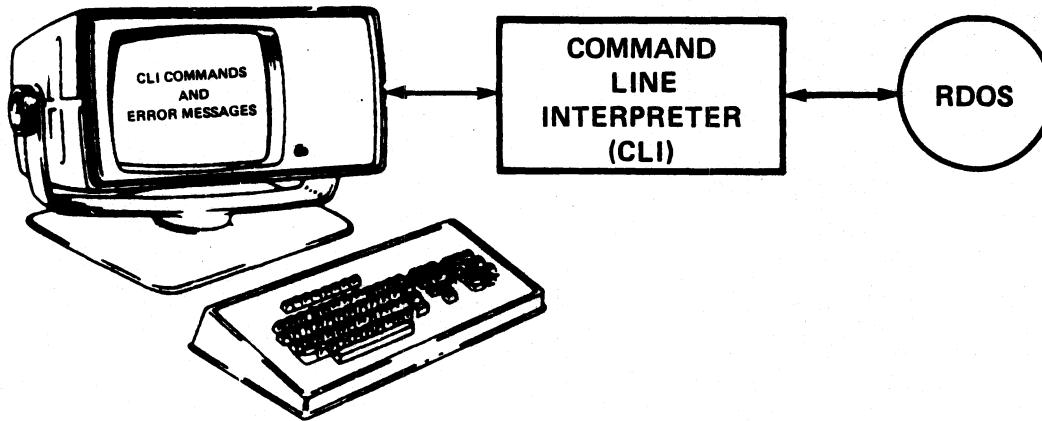

CS-00944

Figure 5.1 The Command Line Interpreter

- File Management
- Invoke Programs
- Manage System Environment

For information on all CLI commands, refer to the *RDOS/DOS User's Handbook* located in the back sleeve of this Student Guide.

Command Line Format

The general format of the CLI is:

R
COMMAND LINE)
CLI response
R

- A. **Command** is the name of the command. It specifies the operation to be performed.

R
COMMAND)
CLI response
R

- B. **Arguments** represent files or other information that the command operates on. One or more spaces, or a single comma, separates the command from its arguments and multiple commands from each other.

R
COMMAND argument(s))
CLI response
R

- C. A **Global Switch** applies to the command itself, not to any argument in the command line; it immediately follows the command and consists of a slash (/) followed by a letter.

R
COMMAND/global-switches argument(s))
CLI response
R

- D. A **Local Switch** follows an argument; it modifies that argument only. A local switch consists of a slash (/) followed by either a number or a letter.

R
COMMAND/global-switches argument(s)/local-switches))
CLI response
R

Some CLI Commands

GTOD

Format — GTOD

Function — Display the current time of day and date.

GSYS

Format — GSYS

Function — Display the name of the current operating system.

Example Dialog

```
FILENAME? STUDENTSYS!  
MAPPED ECLIPSE RDOS REV 6.61  
DATE (M/D/Y)? 5 21 80!  
TIME (H:M:S)? 13 10 00!  
R
```

```
GTOD!  
05/21/80 13:12:30  
R  
GSYS!  
STUDENTSYS  
R
```

STOD

Format — STOD[hour][minute][second]

Function — Set the 24-hr system clock. You can separate arguments with either a space or comma (but not a colon).

SDAY

Format — SDAY month day year

Function — Set the system calendar. You may give the year as either two or four digits (e.g., 77 or 1977). You can separate arguments with either a space or a comma (but not a colon).

Example Dialog

```
R
GTOD\
05/21/80 13:12:30
R
```

```
SDAY 5 22 80\
R
STOD 15 00 00\
R
```

```
GTOD\
05/22/80 15:00:31
R
```

CREATE

Format — CREATE filename₁[...filename_n]

Function — Create one or more sequentially organized files.

Example Dialog

```

R
CREATE FILE1)
R
CREATE FILE2 FILE3 FILE4)
R
CREATE, FILE5, FILE6 FILE7)
R

```

DELETE

Format — DELETE filename₁[...filename_n]

Function — Delete one or more files.

Global Switches

/C — Repeat each filename and wait for the deletion to be confirmed. A carriage return deletes the file; any other key does not.

/L — List the deleted files on \$LPT.

/V — Verify deleted files on the console.

Example Dialog

```

R
DELETE FILE1 FILE2)
R
DELETE/V FILE3 FILE4)
DELETED FILE3
DELETED FILE4
R
DELETE/V/C FILE5 FILE6 FILE7)
FILE5:*
DELETED FILE5
FILE6:
FILE7:*
DELETED FILE7
R

```

XFER

Format — XFER sourcefilename destinationfilename

Function — Copy the contents of sourcefilename to destinationfilename.

Global Switches

/A — Perform an ASCII transfer.

/B — Append the source file to the destination file.

Example Dialog

R
CREATE MYFILE)

R
A. XFER/A/B/\$TTI MYFILE)
THIS SENTENCE IS)
CONTAINED IN MYFILE)

Control-Z
(and Control-L
if necessary)

B. XFER/A/B/ MYFILE \$TTO)
THIS SENTENCE IS
CONTAINED IN MYFILE
R

C. XFER/A/B MYFILE \$LPT)
R

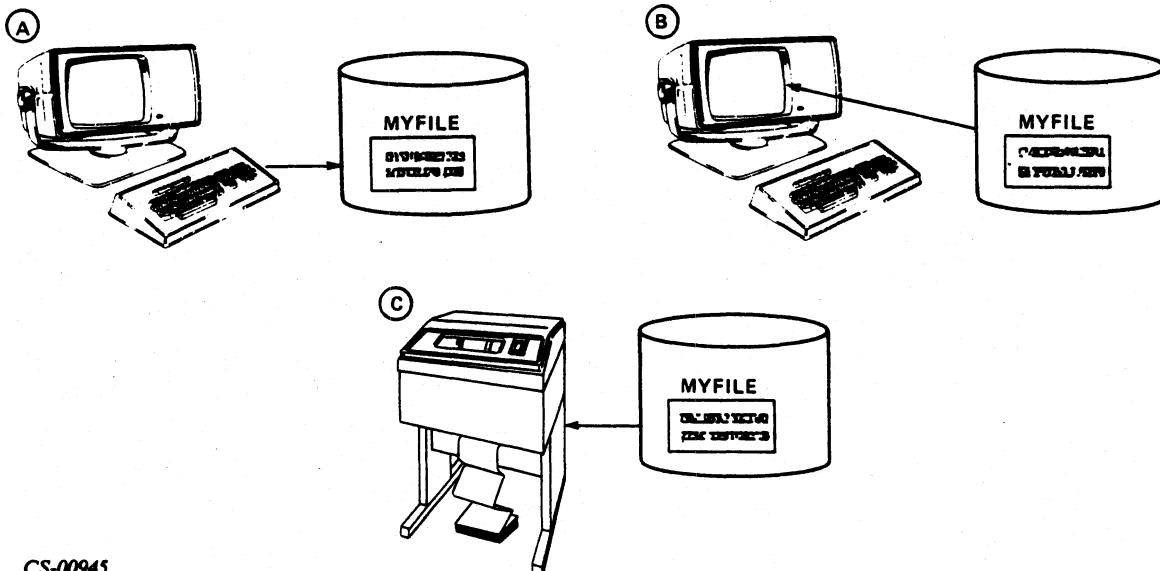

Figure 5.2 XFER Command Examples

TYPE

Format — TYPE filename₁ [...filename_n]

Function — Copy an ASCII filename(s) on the console.

PRINT

Format — PRINT filename₁ [...filename_n]

Function — Print the contents of ASCII filename(s) on the line printer.

Example Dialog

- R
1. TYPE MYFILE)
 - THIS SENTENCE IS
 - CONTAINED IN MYFILE
 - R
 - .
 - .
 2. PRINT MYFILE)
 - R
 - .
 - .
 3. PRINT MYFILE/3 YOURFILE) ← Local Switch Usage
 - R
- Success to MYFILE*

Module 5

Exercise 1

True or False?

1. _____ All CLI commands must be terminated with a carriage return.
2. _____ All CLI commands require at least one argument.
3. _____ A global switch modifies a CLI command.
4. _____ A local switch modifies an argument only.

Name the source file and the destination file in the following CLI command line:

XFER/A/B/\$TTI EXAMPLE

5. Source File: _____
6. Destination File: _____

Write two CLI commands that may be used as alternatives to the following commands:

7. PRINT EXAMPLE _____
8. TYPE EXAMPLE _____

Module 5

Exercise 1 Answers

1. True
2. False
3. True
4. True
5. Source File: \$TTI
6. Destination File: EXAMPLE
7. XFER/A/B EXAMPLE \$LPT
8. XFER/A/B EXAMPLE \$TTO

Recording CLI Dialog

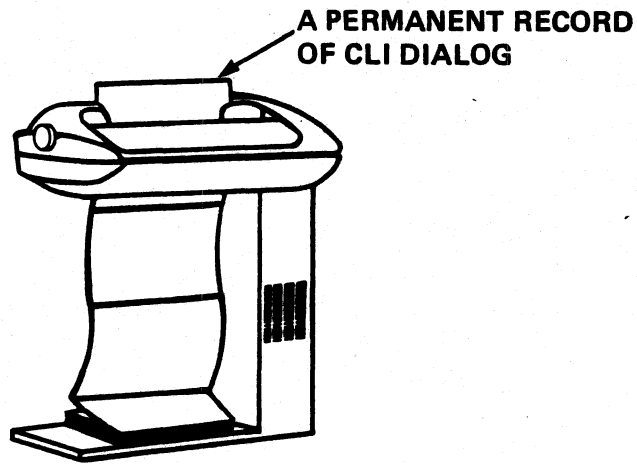

CS-00946

Figure 5.3 Hard-Copy Terminal

Soft-Copy System Terminal

LOG.CM: A file that contains your dialog with the CLI (i.e., all the commands you enter and CLI's responses).

LOG

Format — LOG[*password*][*directory/O*]

Function — Open the log file, LOG.CM, and start recording CLI dialog. *password* is up to 10 alphanumeric characters and prevents LOG.CM from being closed inadvertently. LOG.CM can be closed only by an ENDLOG command containing the *password* (if it was given in the LOG command). LOG.CM can be printed or deleted only after it has been closed.

Global Switches

/H — Place a header at the beginning of the LOG file; include directory, system, and date information.

/T — Trace the execution of CLI commands, including indirects and macros. Before executing each command, the CLI outputs the command to LOG.CM. All trace lines are printed as = = > traceline.

ENDLOG

Format — ENDLOG[*password*]

Function — Close the log file opened by a previous LOG command, and terminate recording of CLI dialog. *password* must match the password given in the LOG command, if any.

Example Dialog

```
FILENAME? STUDENTSYS)
MAPPED ECLIPSE RDOS REV 6.61
DATE (M/D/Y)? 5 21 80)
TIME (H:M:S)? 13 10 00)
R
LOG/H)
R
```

{a day's worth of CLI dialog}

```
ENDLOG)
PRINT LOG.CM)
DELETE LOG.CM)
RELEASE %MDIR%)
MASTER DEVICE RELEASED
```

Error Handling

Correcting typing mistakes before you press carriage return:

- A. One Character at a Time — Press the DEL or RUBOUT key to sequentially erase characters from right to left. On hard-copy devices, each press of DEL or RUBOUT echoes as a backarrow (←) or as an underscore (_).

```
R
CE_READ__TE FILEA)    { = CREATE FILEA }
R
```

- B. Delete an Entire Line — Press backslash (\) or SHIFT and L to delete an entire line.

```
R
CEADE FILEA\
CREATE FILEA)
R
```

Normal Error Handling

- A. R

```
CREATE FILEB)
R
CREATE FILEB)
FILE ALREADY EXISTS; FILEB
```

(reason) (argument that caused the problem)

Unknown Command

Is interpreted as a command to execute a program.

- B. R

```
CEATE FILEC)
FILE DOES NOT EXIST; CEATE.SV
```

(reason) (program that caused the error)

A complete list of CLI error messages is contained in the *RDOS/DOS User's Handbook*.

Control Sequences

CTRL-A: Stops execution of any CLI command.

```
R  
TYPE GETTYSBURG!  
FOUR SCORE AND SEVEN YEARS AGO  
OUR FOREFATHERS BROUGHT FORTH  
ON THIS CON ←Control-A pressed here  
INT  
R
```

CTRL-S: Temporarily stops output to console.

CTRL-Q: Resumes output to console.

CTRL-Z: Terminates input from \$TTI with the XFER command.

CTRL-L: Form Feed (clears display screen).

Programmed Consoles Only (! prompt)

BREAK key: Stops execution of all software.

Uppercase P: Resumes execution of software.

Advanced Features

Several Commands on One Line

The semicolon (;) delimits a command to the CLI; you can then type another command on the same line. No commands are executed until you press carriage return.

```
DELETE FILEA;CREATE FILEB FILEC)
```

Long Command Lines

An up arrow (↑) (SHIFT-N or SHIFT-6 key) typed immediately before a carriage return allows you to span one or more commands over several input lines.

```
DELETE TESTA TESTB↑)
TESTC TESTD)
```

Writing Compact Command Lines

Angle brackets < > and parentheses () allow you to enter complex commands to the CLI in an abbreviated form. The CLI will expand these command lines according to certain rules and then try to execute the expanded lines.

Parentheses

Parentheses expand a command line into Multiple Command Lines. You can place multiple commands or arguments in parentheses and separate them with commas.

A. Multiple Commands

```
(PRINT,DELETE) LOG.CM) expands to PRINT LOG.CM)
DELETED LOG.CM)
```

B. Multiple Arguments

```
CREATE FILE(1,2,3) expands to CREATE FILE1)
CREATE FILE2)
CREATE FILE3)
```

Angle Brackets

C. The arguments enclosed in angle brackets are expanded into a Single Command Line.

```
CREATE FILE <1,2,3>) expands to CREATE FILE1 FILE2 FILE3)
```

General Rules

You must match each opening parenthesis with a closing parenthesis, and each opening angle bracket with a closing bracket. Parentheses can appear within angle brackets (i.e., <()> and vice versa, (< >), but you cannot overlap the sets; <(>) is illegal).

Rules for Parentheses

Parentheses expand a single command line into multiple command lines.

1. Each argument or command within parentheses must be separated by commas.

```
CREATE FILE(1,2 3)
```

does not create FILE3.

2. You can use more than one set of parentheses in a single line. When the CLI encounters more than one set of parentheses in a line, it extracts arguments in turn from each set of parentheses.

```
(PRINT,DELETE) (FILEA, FILEB)
```

expands to

```
PRINT FILEA
DELETE FILEB
```

3. Arguments not in parentheses are executed as usual.

```
(PRINT,DELETE) A (B,C)
```

expands to

```
PRINT A B
DELETE A C
```

4. Parentheses cannot be nested.

```
PRINT FILE(A,B(1,2,3),C)
```

ERROR !!!

5. After each argument in a set of parentheses has been used once, no argument on that string will be used again.

```
(PRINT,DELETE,TYPE) (A,B)
```

expands to

```
PRINT A
DELETE B
TYPE
```

ERROR !!! TYPE requires an argument.

Rules for Angle Brackets

Arguments enclosed in angle brackets are expanded into a single command line.

1. You can separate each argument within angle brackets from the next with one or more commas or spaces.

```
CREATE FILE<1,2 3>!
```

expands to

```
CREATE FILE1 FILE2 FILE3
```

2. Multiple commas or spaces indicate a null argument.

```
CREATE FILE<1,2,>!
```

expands to

```
CREATE FILE1 FILE2 FILE
```

3. You can use multiple sets of angle brackets in command lines.

```
CREATE TEST<1 2> TESTA<1 2>!
```

expands to

```
CREATE TEST1 TEST2 TESTA1 TESTA2
```

4. You can nest angle brackets to any depth. When you nest angle brackets, the CLI expands the innermost level first, then proceeds toward the outermost level. Within each level, arguments are expanded left to right. Within nested brackets, a left or right bracket delimits each bracketed string.

```
PRINT <TEST<01 02 03>>!
```

expands to

```
PRINT <TEST01 TEST02 TEST03>
```

expands to

```
PRINT TEST01 TEST02 TEST03
```

MESSAGE

Format — MESSAGE textstring

Function — Display a message on the console, or insert a message for later display. You can use any ASCII character except carriage returns (\) or semicolons (;) in textstring.

If you place textstring in quotes ("), it will be returned precisely as entered. If you omit quotes, the CLI will interpret certain characters (e.g., @) as commands; also other characters (including parentheses and angle brackets) are illegal.

Global Switch

/P — Pause after displaying textstring and display the message *STRIKE ANY KEY TO CONTINUE* the system will take no action until a console key is pressed.

Example Dialog

```
R
MESSAGE "HELLO THERE" \
HELLO THERE
R
MESSAGE WELCOME TO RDOS \
WELCOME TO RDOS
R
```

Examples**Compact Command Lines with the Message Command**

```

R
MESSAGE (0,1,2) (A,B,C)
0A
1B
2C
R

```

```

R
MESSAGE <0,1,2><A,B,C>
0A 0B 0C 1A 1B 1C 2A 2B 2C
R

```

```

R
MESSAGE (0,1,2) <A,B,C>
0A 0B 0C
1A 1B 1C
2A 2B 2C
R

```

```

R
MESSAGE <0,1,2> (A,B,C)
0A 1A 2A
0B 1B 2B
0C 1C 2C
R

```

```

R
MESSAGE <A,B,(0,1,2)C>
A B0C
A B1C
A B2C
R

```

Module 5

Exercise 2

True or False?

1. _____ The file LOG.CM is automatically opened and closed by the system during system start up and shut down.
2. _____ A CLI command cannot span more than one line.
3. _____ Several CLI commands can be typed on a single line if they are separated by a semicolon (;).
4. _____ You can delete an entire CLI command line by typing SHIFT 6.
5. _____ If the CLI cannot obey a command for any reason, it will usually display an error message followed by the argument that caused the problem.

Match the following control sequences with the function each performs:

6. _____ CTRL-L
 7. _____ CTRL-A
 8. _____ CTRL-Z
 9. _____ CTRL-S
 10. _____ CTRL-Q
- a. Stops the execution of any CLI command.
 - b. Temporarily stops output to the console.
 - c. Resumes output to the console.
 - d. Terminates input from the keyboard with XFER command.
 - e. Clears display screen.

Complete this chart by showing how the CLI will expand the compact lines given:

- | Compact Command | expands to |
|---------------------------|------------|
| 11. (PRINT,TYPE) FILEX | |
| 12. TYPE FILE(X,Y,Z) | |
| 13. (CREATE,DELETE) (X,Y) | |
| 14. CREATE FILE<X,Y,Z> | |

Module 5

Exercise 2 Answers

1. False
2. False
3. True
4. False
5. True
6. e
7. a
8. d
9. b
10. c
11. PRINT FILEX
TYPE FILEX
12. TYPE FILEX
TYPE FILEY
TYPE FILEZ
13. CREATE X
DELETE Y
14. CREATE FILEX FILEY FILEZ

CLI Variables

When the CLI encounters a legal variable, it replaces the variable name with its current value.

Table 5.B A Partial List of CLI Variables

When the CLI encounters this variable name:	It inserts this value:
%DATE%	Today's date, in the form mm-dd-yy.
%GCIN%	The input console name (e.g.,\$TTI)
%GCOUT%	The output console name (e.g.,\$TTO)
%MDIR%	The master directory name (e.g.,DP0)
%TIME%	The time of day, in the form hh:mm:ss.

Example Dialog

```

R
MESSAGE TODAY'S DATE IS %DATE%
TODAY'S DATE IS 05-21-80
R
MESSAGE THE CURRENT TIME IS %TIME%
THE CURRENT TIME IS 15:43:01
R
MESSAGE YOU INPUT CHARACTERS FROM %GCIN%
YOU INPUT CHARACTERS FROM $TTI
R
MESSAGE CHARACTERS ARE OUTPUT TO %GCOUT%
CHARACTERS ARE OUTPUT TO $TTO
R
RELEASE %MDIR%
MASTER DEVICE RELEASED

```

Indirect Files and Macros

Create a file that contains a group of commands. Thereafter, reference these commands by simply using the name of the file.

Indirect Files

R

```
XFER/A %GCIN% DOWN!
MESSAGE STARTING SYSTEM SHUTDOWN AT %TIME%!
ENDLOG!
(PRINT,DELETE) LOG.CM!
MESSAGE/P WAIT UNTIL PRINTING STOPS THEN!
RELEASE %MDIR%!

```

} Create
the file

CTRL-Z

R

```
@DOWN@!
STARTING SYSTEM SHUTDOWN AT 17:31:34
WAIT UNTIL PRINTING STOPS THEN
STRIKE ANY KEY TO CONTINUE
MASTER DEVICE RELEASED

```

← Indirectly
execute file
contents

← Press any
key

Macros (.MC Extension)

R

```
XFER/A %GCIN% DOWN.MC!
MESSAGE STARTING SYSTEM SHUTDOWN AT %TIME%!
ENDLOG!
(PRINT,DELETE) LOG.CM!
MESSAGE/P WAIT UNTIL PRINTING STOPS THEN!
RELEASE %MDIR%!

```

} Create
the file

CTRL-Z

R

```
DOWN!
STARTING SYSTEM SHUTDOWN AT 17:31:34
WAIT UNTIL PRINTING STOPS THEN
STRIKE ANY KEY TO CONTINUE
MASTER DEVICE RELEASED

```

← Execute the
macro

← Press any
key

Macros are self-contained; the name of the macro must be the first word in the command line. A macro cannot be used as an argument to another CLI command.

Indirect Files can be used as an argument to another CLI command:

```
R
XFER/A $TTI FILEA)
HELLO I'M FILEA)
{ctrl-Z}
```

```
R
XFER/A $TTI FILEB)
HELLO I'M FILEB)
{ctrl-Z}
```

```
R
XFER/A $TTI FILEC)
HELLO I'M FILEC)
{ctrl-Z}
```

```
R
XFER/A $TTI GROUP)
(FILEA,FILEB,FILEC)
{ctrl-Z}
R
```

```
TYPE GROUP)
(FILEA,FILEB,FILEC)
R
```

← Direct

```
TYPE @GROUP@)
HELLO I'M FILEA
HELLO I'M FILEB
HELLO I'M FILEC
R
```

← Indirect

The file UP.MC:

```
LOG/H;DELETE NAME.TP
MESSAGE ENTER YOUR NAME AND THEN PRESS CTRL-Z
XFER/A %GCIN% NAME.TP
MESSAGE WELCOME TO %GSYS% @NAME.TP@
```

Execution of UP.MC after a bootstrap:

```

FILENAME? STUDENTSYS)
MAPPED ECLIPSE RDOS REV 6.12
DATE (M/D/Y)? 5 21 80)
TIME (H:M:S)? 13:22:00)
R
UP)
ENTER YOUR NAME AND THEN PRESS CTRL-Z
BILL)
{ctrl-Z}
WELCOME TO STUDENTSYS BILL

```

Table 5.C CLI Punctuation

Symbol	Function	Example
↵ or ↓	The carriage return key (↵) terminates an input command line and activates the CLI. The CTRL and L keys (↓) have the same effect.	CREATE A B ↵ CREATE A B ↓
\	The SHIFT and L keys or backslash key (\) delete an entire line.	CCREAGE\ CC←READ←TE
RUBOUT or DEL	The RUBOUT or DEL key (echoed as ← or — on teletypewriters) erases the last character entered. On CRT displays the last character will disappear each time you press RUBOUT.	DELETE A,B ↵ DELETE A B ↵ DELETE A B ↵
□	The comma or space is used to separate arguments. Extra spaces have no effect.	DELETE/V A ↵
/	The slash key before a character specifies a switch.	CREATE A; TYPE B ↵
;	The semicolon (;) delimits a command to CLI; you can then type another command on the line. No commands are executed until you enter a carriage return.	CREATE A; TYPE B ↵
↑	The SHIFT and N or SHIFT-6 keys (↑) followed immediately by RETURN can extend command lines over multiple lines.	· ·
.}	This command adds or removes the time of day to the prompt.	.} 14:34:54 R
() <>	Parentheses and angle brackets are used when entering compact command lines to CLI.	(PRINT,DELETE) ↵ LOG.CM CREATE <A,B,C,D> .SR ↵
@ .MC	Commercial at signs indicate the content of a file, rather than the filename itself. The .MC extension designates a macro file.	TYPE @FOO@ ↵ DAYSEND ↵
""	Quotation marks delimit a literal text string. They are most useful with the MESSAGE command.	MESSAGE "HELLO" ↵
%	Percent signs enclose a CLI-defined variable.	RELEASE %MDIR% ↵

Module 5

Lab Exercise

Directions: The following Lab Exercise provides practice in the CLI commands and concepts presented in this module. You may refer to either the information presented in the Student Guide or the *RDOS/DOS User's Handbook*.

If you have a computer running RDOS that is available for your use, then enter the commands that will perform the operations described below. The CLI will tell you if you do something wrong. If you don't have a computer, write the commands in the space provided. Check your answers with those provided at the end of the lab.

1. Start recording the CLI dialog in the log file.

2. Create a file called MINE that contains the sentence: THIS IS MY FIRST FILE. (Don't forget the CTRL-Z and the switches.)

3. Use the XFER command to:
 - a. Display the contents of MINE on the terminal.

 - b. Send a copy of MINE to the line printer.

4. Use alternative commands to perform the functions described in Question 3.
 - a.

 - b.

5. Copy the contents of MINE into a new file MYCOPY.

6. Use the XFER command and a CLI variable to display the contents of MYCOPY on the terminal.

7. Delete MINE and send the delete verification to the line printer.

8. Create a macro that will display in meaningful sentences the date, time, and name of the system directory. This macro will be executed by typing the word FACTS.

9. End the recording of CLI dialog.

10. Print the log file.

11. Delete the log file and MYCOPY in one command line.

Module 5 Quiz

Given the following CLI dialog, show the CLI's response and explain the consequences:

1. *R*
SDAY 7 4 80!
MESSAGE %DATE%!

CLI response: _____

Explanation: _____

2. *R*
XFER/A/B %GCIN% \$LPT!
THIS IS A TEST!
{ctrl-Z}

CLI response: _____

Explanation: _____

3. *R*
CREATE TEST1!
XFER/A %GCIN% TEST1!

CLI response: _____

Explanation: _____

4. *R*
XFER/A \$TTI ONE!
TWO!
{ctrl-Z}

R

- XFER/A \$TTI TWO!
I'M FILE TWO!

{ctrl-Z}

R

- TYPE @ONE@!

CLI response: _____

Explanation: _____

5. R
 XFER/A \$TTI T2.MC)
 (CREATE,DELETE/V) F<1,2>)
 {ctrl-Z}
 R
 T2)

CLI response: _____

Explanation: _____

Match the following CLI commands, punctuation, and control sequences with the functions they perform.

- | | |
|------------------------------------|--|
| 6. _____ STOD | a. Displays the name of the current operating system. |
| 7. _____ TYPE | b. Sets the 24-hr system clock. |
| 8. _____ CTRL-A | c. Creates one or more files. |
| 9. _____ .MC Extension | d. Copies the contents of one file into another file. |
| 10. _____ DEL or RUBOUT Key | e. Starts the execution of a CLI command. |
| 11. _____ LOG | f. Prints the contents of a file on the line printer. |
| 12. _____ Semicolon (;) | g. Begins recording CLI dialog in the log file. |
| 13. _____ GTOD | h. Deletes one character in a command line. |
| 14. _____ XFER | i. Displays the contents of a file on the terminal. |
| 15. _____ CTRL-L | j. Stops execution of any CLI command. |
| 16. _____ Backslash (\) or Shift L | k. Required on all macros. |
| 17. _____ CREATE | l. Temporarily stops output to the console. |
| 18. _____ ENDLOG | m. Separates CLI commands on the same line. |
| 19. _____ GSYS | n. Expands a command line to multiple command lines. |
| 20. _____ SDAY | o. Clears the display screen. |
| 21. _____ Angle Brackets < > | p. Displays a message on the console. |
| 22. _____ DELETE | q. Causes the CLI to access the contents of a file, rather than the file itself. |
| 23. _____ Carriage Return) | r. Deletes one or more files. |
| 24. _____ CTRL-Z | s. Displays the current time and date. |
| 25. _____ CTRL-S | t. Stops the recording of CLI dialog. |
| 26. _____ MESSAGE | u. Terminates input from \$TTI with the XFER command. |
| 27. _____ PRINT | v. Resumes output to the console. |
| 28. _____ CTRL-Q | w. Allows a command to span more than one line. |
| 29. _____ Parentheses () | x. Expands arguments in a single command line. |
| 30. _____ Up Arrow (↑) | y. Sets the system date. |
| 31. _____ Commercial at sign (@) | z. Deletes an entire command line. |

Complete the following sentences:

32. A command line's _____ represents a file or other information, which the command operates on.
33. A file that contains CLI commands and the name of which ends with .MC is called a _____.
34. As an alternative to the type of file described in Question 33, you can use an _____ file, which does not require a .MC extension and may be used as an argument to another CLI command.
35. A _____ switch modifies a CLI command.
36. A _____ switch modifies an argument in a command line.
37. You can record CLI dialog in a special file maintained by RDOS called _____.
38. You can access certain system information, such as current time or master directory name, using _____, which are enclosed in percent signs.

Check your answers with those given in *Appendix A: Quiz Answers*. Score one point for each correct answer. The maximum score is 38 points. Mastery level is 33 points. If you achieve mastery level, continue on to Module 6. Otherwise, review the material presented in this module before continuing.

Module 6

Secondary Storage

Introduction

This module is concerned with the management of information stored on secondary storage devices. As you know, RDOS supports the two most common types of secondary storage: magnetic tape for sequential access and magnetic disc for direct access. Both provide versatile and economical methods for the long term storage of large amounts of information. The first part of this module is concerned with discs; the second part deals with magnetic tape storage.

Learning Objectives

Upon successful completion of this module you will be able to:

1. Differentiate among contiguous, sequential, and random files.
2. Differentiate among primary partitions, secondary partitions, and subdirectories.
3. Identify and use the CLI commands that perform the following functions:

- Bootstrap a program
- Create a list of filenames
- Create a contiguous file
- Create a sequential file
- Create a random file
- Create a secondary partition
- Create a subdirectory
- Display the name of the current directory
- Display the name of the last directory
- Display the name of the master directory
- Display disc space information
- Display directory file information
- Copy a file from one directory into another directory
- Create a link entry
- Remove a link entry

- Change a file's attributes
- Change a file's link attributes
- Transfer files to and from magnetic tape drives
- Initialize a directory or device
- Release a directory or device

4. Identify the meaning of the following terms:

- Disc Block
- Logical Block Address
- Master Directory
- Current Directory
- Initialization
- Directory Specifier
- Link Entry
- Resolution File
- Characteristics
- Attributes
- Templates
- MAP.DR
- SYS.DR
- User File Description
- Hash Value Offset
- Frame Size
- Disc Editor
- Dump Format
- Copy Format
- Logical End of Tape

5. Describe the function of a link entry.
6. Identify the important features of file characteristics and attributes.
7. Use CLI templates to match filenames.
8. Identify the features of selected RDOS internal data structures.
9. Identify the purpose and function of filename hashing.
10. Reference a file on magnetic tape.
11. Identify the characteristics of magnetic tape storage.

Resources

1. RDOS Student Guide, Module 6
2. Audiocassette tape for Module 6

Module Outline

1. Disc Organization
 - a. Physical/Logical Organization
 - b. File Types
 - c. Exercise 1
 - d. Directory Structures
 - e. CLI Directory Commands
 - f. Exercise 2
 - g. Directory Specifiers
 - h. Link Entries
 - i. Initialization and Release
 - j. Exercise 3
 - k. Filename Characteristics and Attributes
 - l. Filename Templates
 - m. Exercise 4
 - n. Lab Exercise
 - o. Introduction to RDOS Internals
 - p. Exercise 5
 - q. Disc Editor
 - r. Exercise 6
2. Magnetic Tape Secondary Storage
 - a. Sequential Organization
 - b. Referencing File on Tape
 - c. Disc/Tape Transfers
 - d. Exercise 7
3. Module Quiz

Directions

Turn to Figure 6.1 and listen to the audiocassette tape for Module 6.

Disc Organization

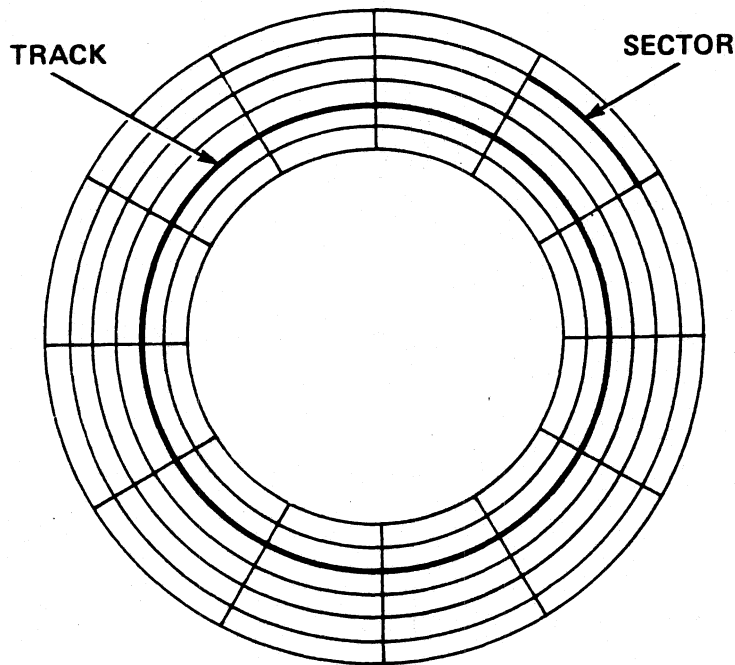

CS-00947

Figure 6.1 Magnetic Disc

Physical Organization

Platter — Record-shaped plate coated with magnetic material.

Track — Concentric rings of data.

Sector — 256 words of data. The smallest addressable unit of information.

Logical Organization

Block — Primary logical unit of data, 256 words long.

LBA — Logical Block Address. A unique logical address for each disc block. Derived from the physical disc's sector, track, and surface number.

Files — Sequential, random, and contiguous.

Contiguous Disc File

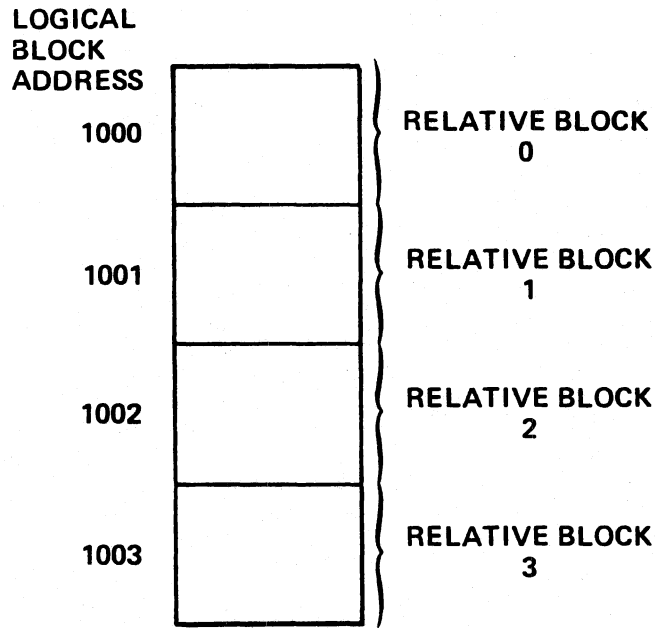

CS-00948

Figure 6.2 Contiguous Disc File Structure

- A *Contiguous File* is a fixed number of blocks located at an unbroken series of logical block addresses.
- The *Relative Block Number* denotes the relative position of each block within its disc file.
- Contiguous Files provide the *fastest possible access* to data.
- *File size is fixed* at the time of creation and cannot be subsequently altered.

CCONT

Format — CCONT filename₁ blkct₁ [...filename_n blkct_n]

Function — Create one or more contiguously organized files. You specify the length in blocks in blkct.

Global Switches

/N — Do not zero each block in the new files (by default the system zeros each).

Example

```
CCONT MYC 4;
```

Sequential Disc Files

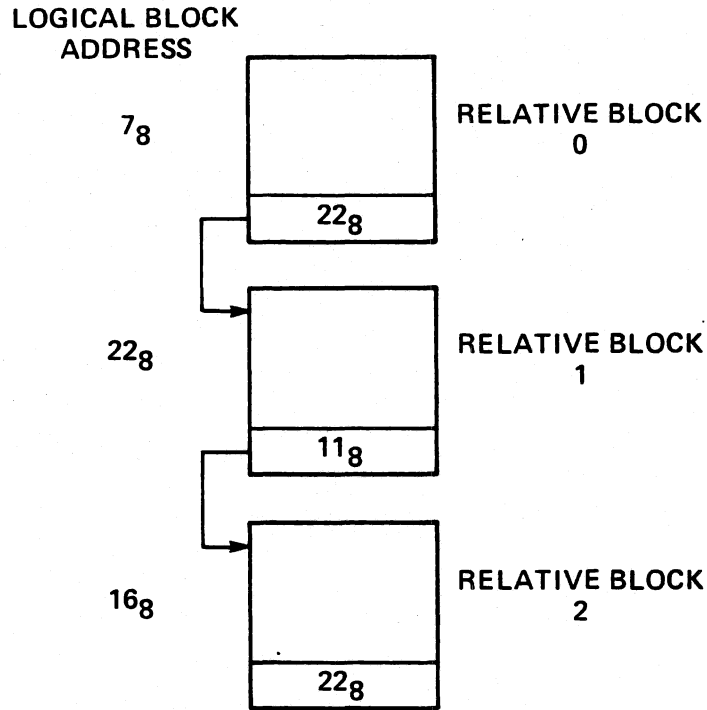

CS-00949

Figure 6.3 Sequential Disc File Structure

- Expandable.
- The logical block addresses of a sequential file are seldom contiguous (blocks are seldom physically adjacent).
- The last word (or two) of each block is reserved for a link to the next block.
- RDOS can step sequentially forward or backward through the file.

Random Disc Files

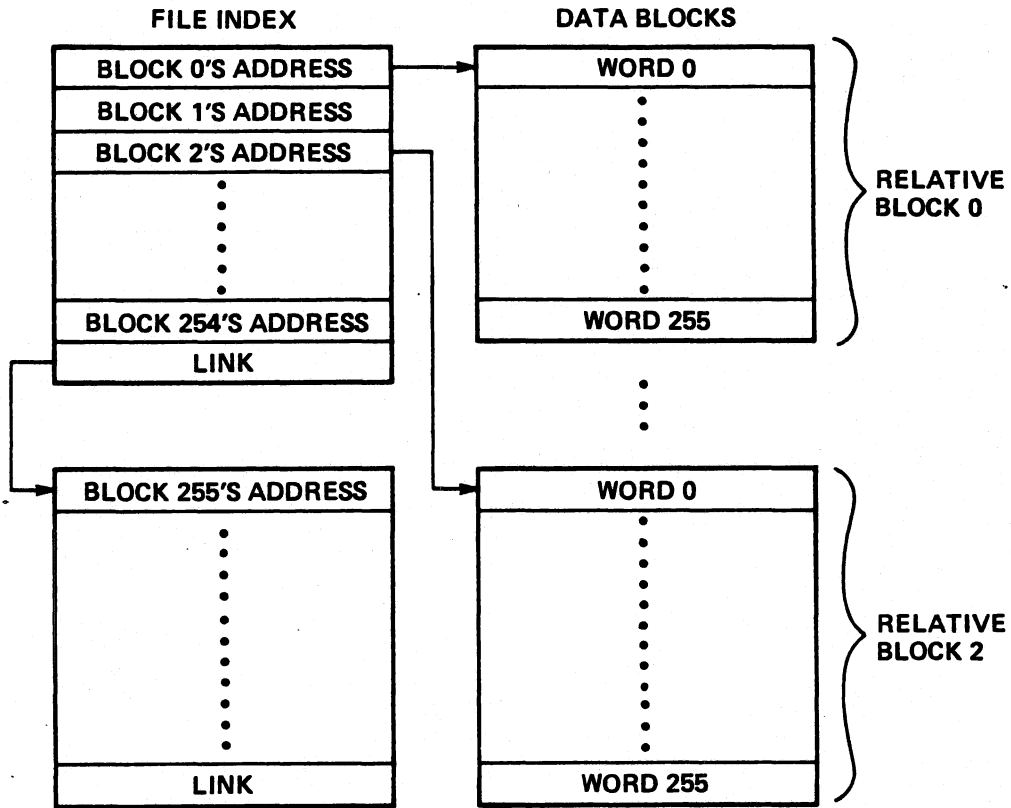

INDEX ENTRIES ARE TWO WORDS FOR SOME DISCS.

CS-00950

Figure 6.4 Random Disc File Structure

- File index contains logical block addresses of actual data blocks.
- Last entry in file index block is a link to the next file index block, as required.
- Best compromise between access time and efficient use of available disc space.

CRAND

Format — CRAND filename₁ [... filename_n]

Function — Create one or more randomly organized files.

Example

CRAND MYR)

Module 6

Exercise 1

1. The primary logical unit of data on a disc is 256 words long and is called a _____.
2. Each such logical unit has an associated address called its _____.

In Questions 3 through 5, one or more answers may be correct.

3. Which of the following are characteristics of *random* files?
 - a. The last word of each block points to the next data block.
 - b. The best compromise between fast access and efficient use of disc space.
 - c. Index block(s) contain LBAs of actual data blocks.
4. Which of the following are characteristics of *sequential* files?
 - a. The best compromise between fast access and efficient use of disc space.
 - b. Expandable.
 - c. The last word of each data block points to the next data block.
5. Which of the following are characteristics of *contiguous* files?
 - a. Consists of a fixed number of physically adjacent disc blocks.
 - b. Size cannot change after creation.
 - c. Allows the fastest possible access to data.
6. What is the CLI command that creates a contiguous file?
7. What is the CLI command that creates a random file?
8. What is the CLI command that creates a sequential file?

Module 6

Exercise 1 Answers

1. Block
2. Logical Block Address (LBA)
3. b, c
4. b, c
5. a, b, c
6. CCONT
7. CRAND
8. CREATE

Disc Structures

Disc Directory: An index that lists information about a group of files, which occupies a portion of available disc file space.

1. Partition: A fixed portion of total disc space.
 - Primary Partition: Total storage area on each disc.
 - Secondary Partition: A fixed portion of the primary partition.
2. Subdirectory: A variable portion of a partition.

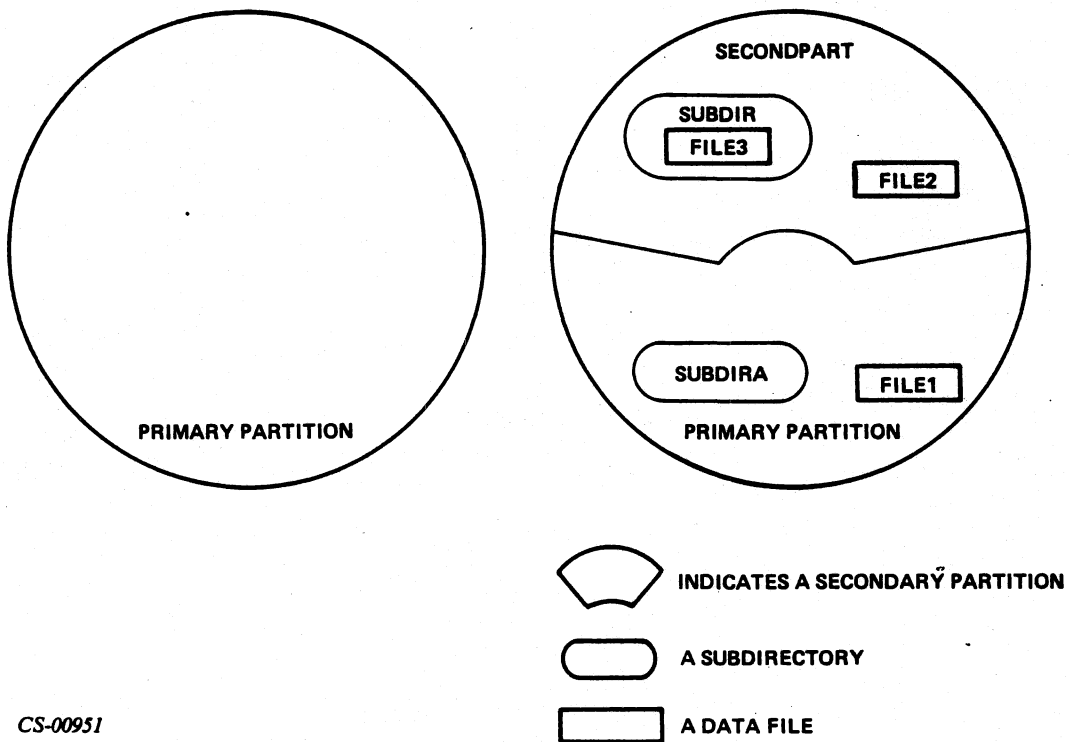

CS-00951

Figure 6.5 Example Disc Structure

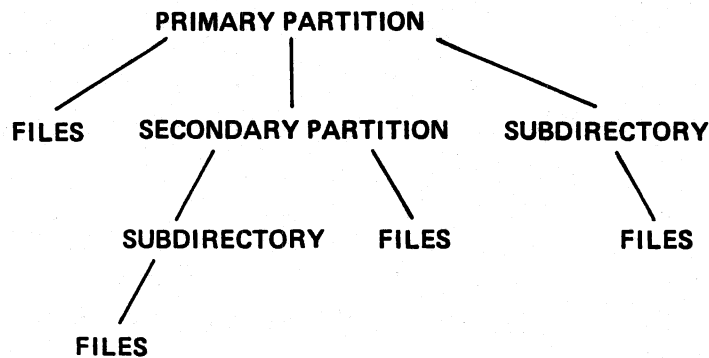

CS-00952

Figure 6.6 Directory Hierarchy

Table 6.A Primary Partitions – Reserved Names

Disc Drive	Primary Controller	Secondary Controller
Models 6001-6008 Fixed Head	DK0	DK1
Model 6063/6064 Fixed Head	DS0 DS1 DS2 DS3	DS4 DS5 DS6 DS7
Model 6060/6061/6067/6122 Multiple Platter Packs	DZ0 DZ1 DZ2 DZ3	DZ4 DZ5 DZ6 DZ7
Model 6045 series 6050,6070,4234A Moving Head These units have two logically distinct discs each: The top disc is removable cartridge, the bottom disc is fixed and cannot be removed.	Removable Portion- DP0 DP1 DP2 DP3 Fixed Portion- DP0F DP1F DP2F DP3F	DP4 DP5 DP6 DP7 DP4F DP5F DP6F DP7F
Other types of Moving- Head discs and diskettes.	DP0 DP1 DP2 DP3	DP4 DP5 DP6 DP7

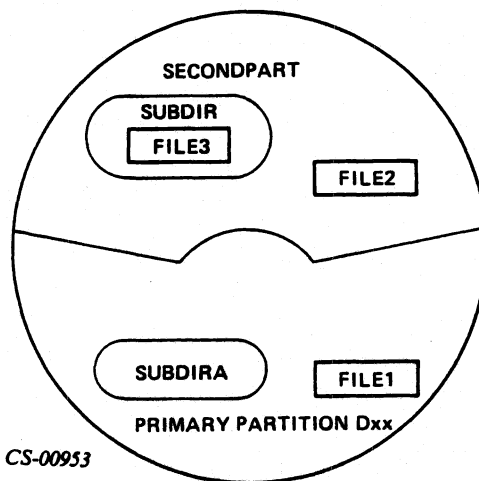

CS-00953

Figure 6.7 Generic Name: Dxx

NOTE: This course uses the generic name Dxx. Substitute the name that applies to your disc.

Disc Terminology

Initialization — Opens a partition or subdirectory so that you can access the files or subdirectories contained within (partial initialization).

Master Directory — The partition that holds the current RDOS system is usually DP0, DP0F, DZ0, or DS0, but may also be any primary partition listed in Table 6.A or a secondary partition within one of these primary partitions.

Current Directory — RDOS directs its attention to this directory. It only searches for files in this directory unless you have told it to search elsewhere. Only one directory is the current directory at a given time.

Current and Master Directories

GDIR

Format — GDIR

Function — Display the name of the current directory.

MDIR

Format — MDIR

Function — Display (on the console) the name of the current master directory.

Table 6.B CLI Variables

When the CLI encounters this variable name:	It inserts this value:
%GDIR%	The current directory name.
%MDIR%	The master directory name (e.g., DP0).

Example Dialog

FILENAME? STUDENTSYS)
MAPPED ECLIPSE RDOS REV 6.61
DATE(M/D/Y)? 6 25 80)
TIME(H:M:S)? 8:05:00)
R
LOG/H)
R
GDIR)
Dxx
MDIR)
Dxx
MESSAGE THE CURRENT DIRECTORY IS %GDIR%
THE CURRENT DIRECTORY IS Dxx
R
MESSAGE THE MASTER DIRECTORY IS %MDIR%
THE MASTER DIRECTORY IS Dxx
R

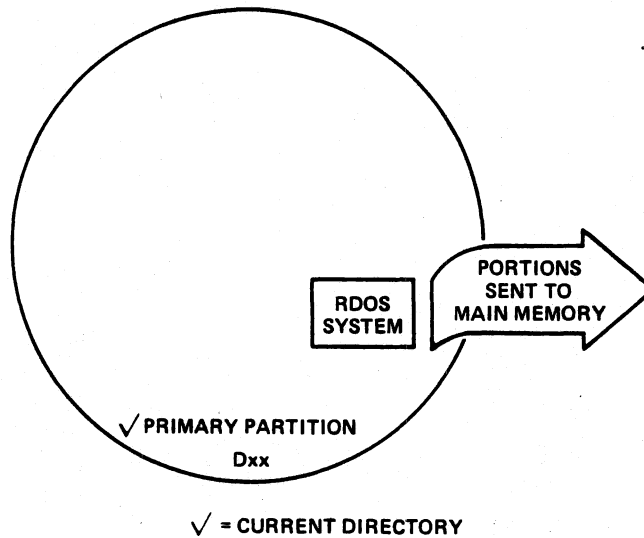

CS-00954

Figure 6.8 The Current and Master Directory

Creating a Subdirectory

Example Dialog

```
CREATE FILE1)  
R  
XFER/A/B $TTI FILE1)  
I'M FILE ONE )  
{ctrl-Z}  
R
```

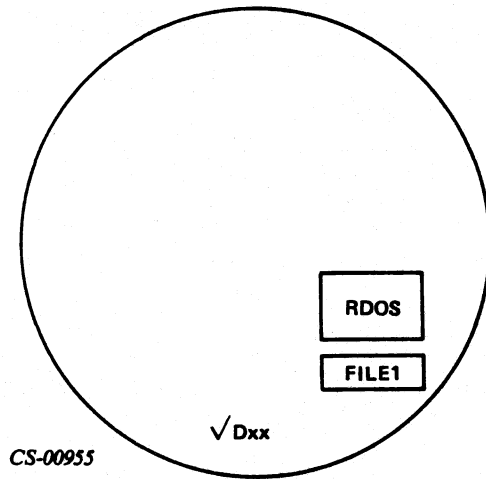

Figure 6.9 Creating a File

CDIR

Format — CDIR directoryname

Function — Create an RDOS subdirectory. The CLI assigns the .DR extension to directoryname.

Example Dialog

```
CDIR SUBDIRA )
```

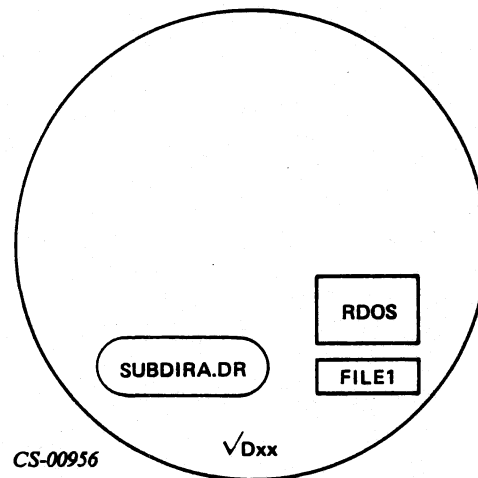

Figure 6.10 Creating a Subdirectory

Creating a Secondary Partition

DISK

Format — DISK

Function — Display the decimal count of the number of blocks used and the number still available in the current partition or diskette. If the current directory is an RDOS subdirectory the size of the parent partition is indicated.

CPART

Format — CPART partitionname blocks

Function — Create an RDOS secondary partition, with a .DR extension, as a contiguous file whose length in blocks is given by blocks; blocks must be more than 48. If blocks is not an integer multiple of 16, it is truncated to the next lower multiple.

Example Dialog

```
R
DISK!
LEFT: 7185  USED: 2591
R
CPART SECONDPART 500!
R
DISK!
LEFT: 6689  USED: 3087
R
```

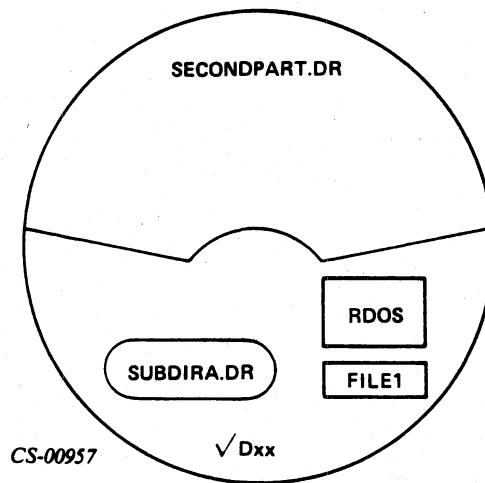

Figure 6.11 Creating a Secondary Partition

Changing the Current Directory

DIR

Format — DIR directory

Function — Change the current directory to directory, initializing the new directory if necessary.

LDIR

Format — LDIR

Function — Display the name of the last current directory (the directory last specified in a DIR command).

Table 6.C CLI Variable

When the CLI encounters this variable name:	It inserts this value:
%LDIR%	The name of the previous current directory.

Example Dialog

```

DIR SECONDPART)
R
GDIR)
SECONDPART
R
DISK)
LEFT: 475  USED: 21
R
LDIR)
Dxx
R
MESSAGE THE LAST DIRECTORY WAS %LDIR%)
THE LAST DIRECTORY WAS Dxx
R

```

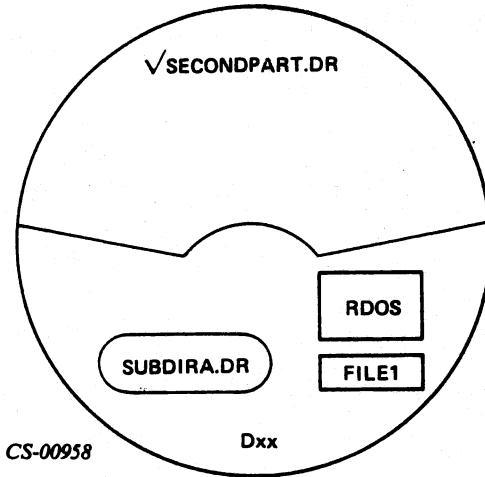

Figure 6.12 Changing the Current Directory

```
CREATE FILE2)
XFER/A/B $TTI FILE2)
I'M FILE TWO)
{ctrl-Z}
R
TYPE FILE2)
I'M FILE TWO
R
TYPE FILE1)
FILE DOES NOT EXIST: FILE1
R
```

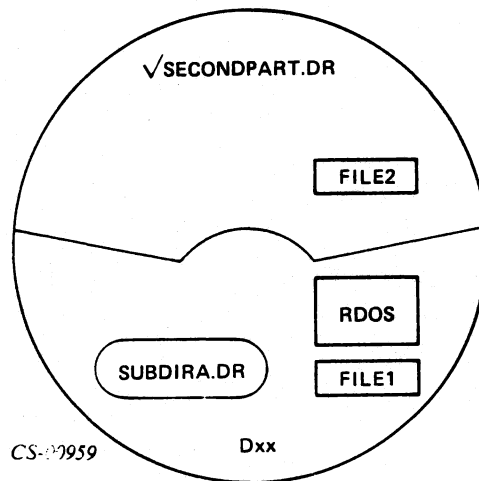
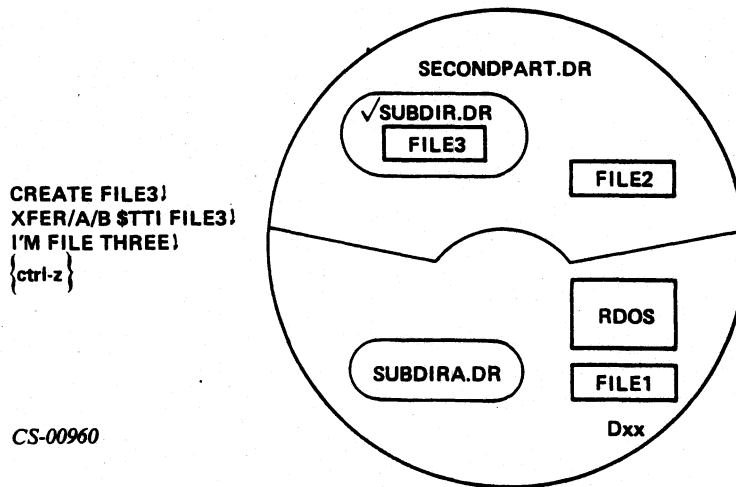
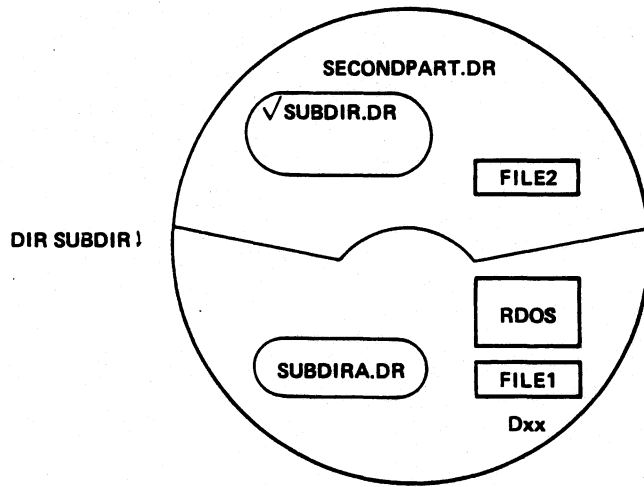
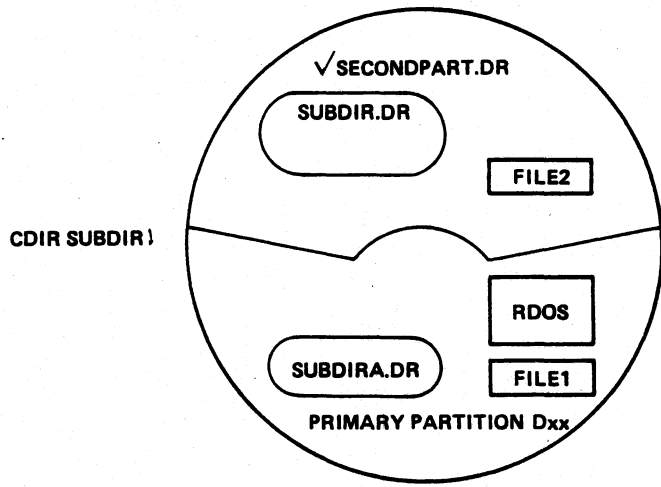

Figure 6.13 Creating Another File



CS-00960

Figure 6.14 Completing the Disc Structure

Module 6

Exercise 2

1. Before you can access the files contained in a directory, the directory must first be opened. This process is called _____.
2. The _____ directory holds the current operating system.
3. When it looks for files, RDOS directs its attention to the _____ directory.

In Questions 4 through 6, one or more answers may be correct.

4. Which of the following are characteristics of a primary partition?
 - a. Represents the total area for storage on a disc
 - b. May contain a secondary partition
 - c. May contain a subdirectory
 - d. May reside in a secondary partition
5. Which of the following are characteristics of a secondary partition?
 - a. May reside in the primary partition
 - b. May contain a primary partition
 - c. Is a fixed portion of the total amount of disc space
 - d. May contain subdirectories
6. Which of the following are characteristics of a subdirectory?
 - a. May reside in a primary partition
 - b. May reside in a secondary partition
 - c. May reside in another subdirectory
 - d. A variable portion of a partition

Name the CLI commands that perform the following functions:

7. Display the name of the master directory. _____
8. Create a subdirectory. _____
9. Change the current directory. _____
10. Display the name of the last current directory. _____
11. Create a secondary partition. _____
12. Display the name of the current directory. _____
13. Display disc space information. _____

Module 6

Exercise 2 Answers

1. Initialization
2. Master
3. Current
4. a, b, c
5. a, c, d
6. a, b, d
7. MDIR
8. CDIR
9. DIR
10. LDIR
11. CPART
12. GDIR
13. DISK

Directory Specifiers

Example Dialog

```

GDIR)
SUBDIR
R
TYPE FILE3)
I'M FILE THREE
R
TYPE FILE2)
FILE DOES NOT EXIST: FILE2
R
TYPE FILE1)
FILE DOES NOT EXIST: FILE1
R
TYPE Dxx:FILE1)
I'M FILE ONE
R
TYPE Dxx:SECONDPART:FILE2)
I'M FILE TWO
R
    
```

Directory Specifier — The names of a file's parent directories in descending order separated by colons (:).

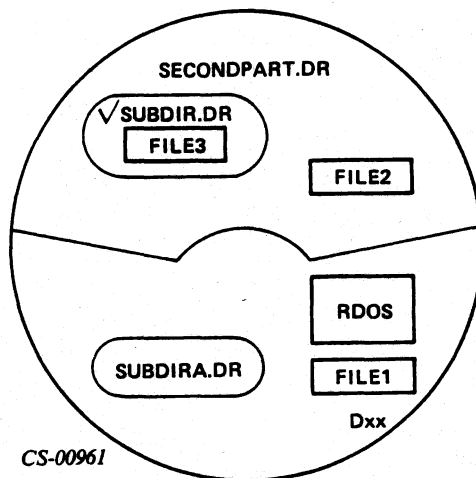

CS-00961

Figure 6.15 Example Disc Structure

Link Entries

LINK

Format — LINK { linkname/directory:]resfilename
resfilename/2 }

Function — Create a link entry in the current directory to a resolution file (resfilename) or to another link entry. Use the first format if:

1. You want your link's name to differ from the resolution file's name; or
2. The resolution file is not in the current directory's parent directory.

Use the second format to link to a file in the current directory's parent directory. The parent directory holds the current directory. This form gives the link the same name as the resolution file.

Example Dialog 1

```

GDIR)
SUBDIR
R
TYPE FILE1)
FILE DOES NOT EXIST: FILE1
R
LINK F1 Dxx:FILE1)
R
TYPE F1)
I'M FILE ONE
R
    
```

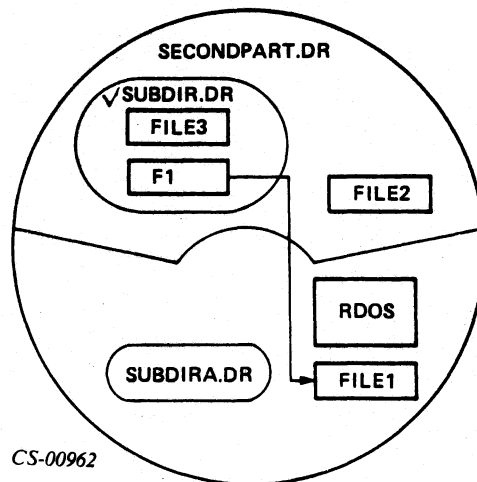

CS-00962

Figure 6.16 A Link Entry — File 1

Example Dialog 2

LINK FILE2/2\
R
TYPE FILE2\
I'M FILE TWO
R

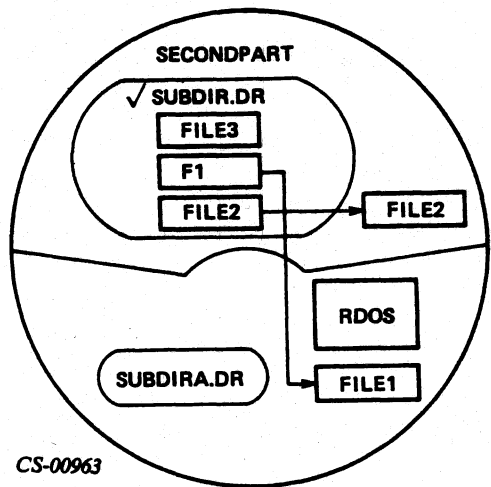

CS-00963

Figure 6.17 A Link Entry -- File 2

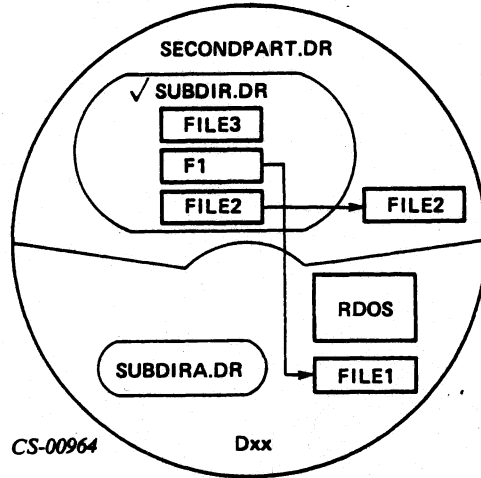

Figure 6.18 DELETE Removes the Resolution File (Part A)

The command DELETE F1) removes the file, not the link.

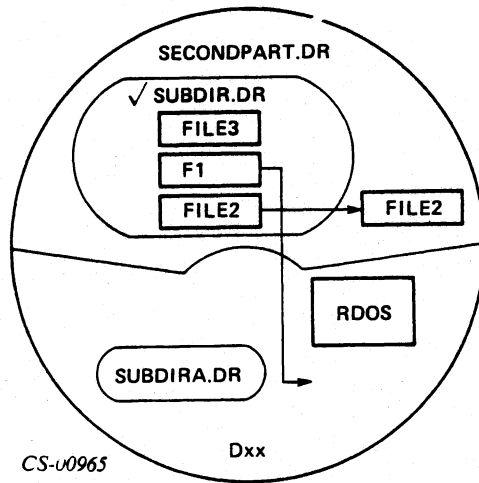

Figure 6.18 DELETE Removes the Resolution File (Part B)

Removing a Link

UNLINK

Format — UNLINK linkname₁[. . . linkname_n]

Function — Delete link entries from any directory. The resolution file is unaffected.

Global Switches

/C — Display each link name on the console and wait for confirmation that the link is to be unlinked. Type RETURN to remove the link entry or any other key to retain the link entry.

/L — List deleted files on \$LPT (overrides /V).

/V — Verify deletions on the console.

Local Switches

/N — Do not delete links matching this name.

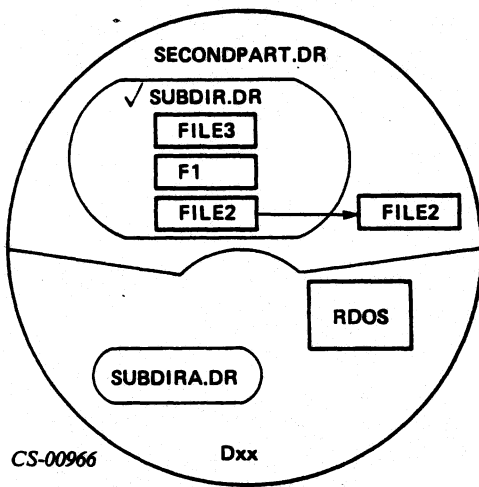

Figure 6.19 Removing a Link (Part A)

The command UNLINK FILE2) removes the link.

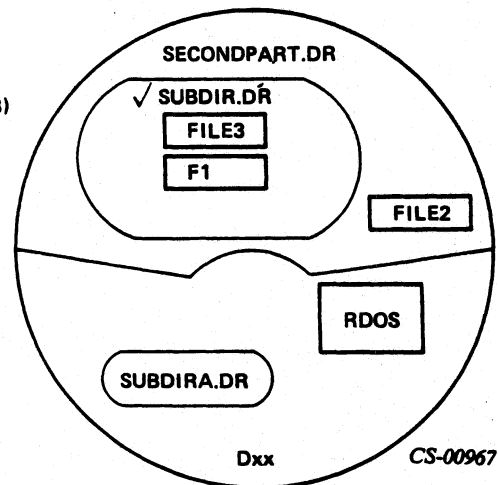

Figure 6.19 Removing a Link (Part B)

Disc Initialization and Removal

INIT

Format — INIT { *tapedrive*
 [*directoryspecifier:*]*directory* }

Function — Initialize a *tapedrive* or *directory* for I/O access. In RDOS, *directoryspecifier* can be:

dir[:subdir]

You can omit *directoryspecifier* if *directory* is a direct subordinate to the current *directory*.

A file in a *directory* cannot be accessed until its *directory* and all superior *directories* are initialized.

Global Switches

/F — Full initialization, clearing all information from the *directory*. This destroys all existing files. On a disc, INIT/*F* writes a new file *directory* and storage map. On a tape, INIT/*F* writes two EOFs (logical EOT) at the beginning.

RELEASE

Format — RELEASE { *tapedrive*
 [*diskdirectory*] }

Function — Logically remove an initialized *tape drive* or *directory* from the system. RELEASE *tapedrive* rewinds the tape on *tapedrive*. You must RELEASE a disc before physically removing it from its drive.

To shut down the system, release the master *directory*. Releasing the master *directory* releases all initialized *directories* and *tape drives*. In a dual-program environment, the master *directory* cannot be released from the foreground, or while the foreground is running.

Example Dialog

```

DIR Dxx)
R
TYPE FILE2)
FILE DOES NOT EXIST: FILE2
R
TYPE SECONDPART:FILE2)
I'M FILE TWO
R
LINK FILE2 SECONDPART:FILE2)
R
TYPE FILE2)
I'M FILE TWO
R
RELEASE SECONDPART)
R
TYPE SECONDPART:FILE2)
NO SUCH DIRECTORY: SECONDPART:FILE2
R
TYPE FILE2)
NO SUCH DIRECTORY: FILE2
R
INIT SECONDPART)
R
TYPE SECONDPART:FILE2)
I'M FILE TWO
R
TYPE FILE2)
I'M FILE TWO
R
RELEASE Dxx)
MASTER DEVICE RELEASED
    
```

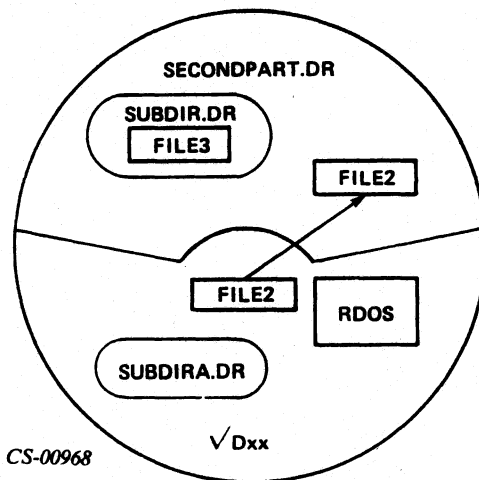

Figure 6.20 Example Disc Structure

STUDENTSYS Disc Structure

Subdirectories in the Primary Partition

- SYSGEN contains the programs used to generate the tailored operating system. The actual system itself also resides here.
- UTIL contains utility programs supplied by Data General.

Files in the Primary Partition

- STUDENTSYS.SV, STUDENTSYS.OL are links that point to the actual operating system.

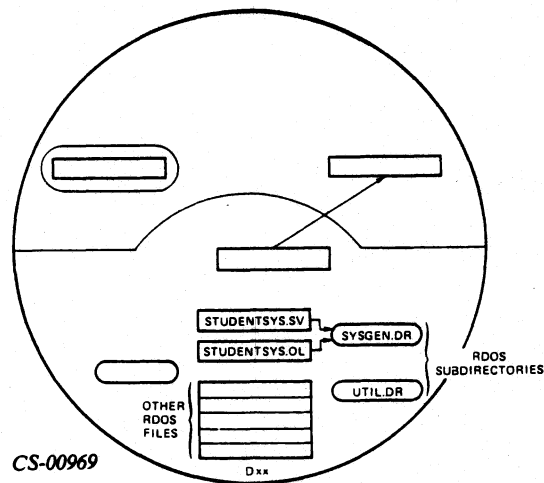

Figure 6.21 Student Disc Structure

Module 6

Exercise 3

1. One way to reference a file that is outside of the current directory is to use a _____, which lists the names of the file's parent directories in descending order, separated by colons (:).
2. Another way is to use a link entry. Describe how a link entry works.

Name the CLI commands that perform the following functions:

3. Create a link entry. _____
4. Remove a link entry. _____
5. Initialize a directory. _____
6. Release a directory. _____

Module 6

Exercise 3 Answers

1. Directory Specifier
2. A link entry is a file in one directory that points to a file in another directory.
3. LINK
4. UNLINK
5. INIT
6. RELEASE

Properties of Files

Characteristics are determined when you create a file.

Table 6.D Characteristics

Code	Meaning
C	Contiguous File
D	Random File
(No code)	Sequential File
L	Link Entry
T	Partition
Y	Subdirectory

Attributes protect a file; some may be changed.

Table 6.E Attributes

Code	Meaning
P	A permanent file. No one can delete or rename it.
R	A read-protected file. No one can read or make copies of this file.
W	A write-protected file. No one can modify this file. (It can be deleted.)
N	Protected from linking. No one can use this file as a resolution file in a link entry.
S	A "save" (executable) file. No file can be executed without the S attribute. You can deny execute access by removing the S attribute.
?	First user-defined attribute.
&	Second user-defined attribute.
A	This is an attribute-protected file. The attributes of such a file cannot be changed. After the A attribute has been set, it cannot be removed.

Changing a File's Attributes

CHATR

Format — CHATR filename₁ $\left\{ \begin{array}{c} + \\ - \end{array} \right\}$ attrib₁ [...filename_n $\left\{ \begin{array}{c} + \\ - \end{array} \right\}$...attribs_n]

Function — Add or remove file access attributes (attribs) to a file. To add an attribute, precede it with a plus sign (+); to remove an attribute, precede it with a minus sign (-); to remove all attributes enter 0 as an argument; to retain all existing attributes use an asterisk (*).

Attributes

N — Do not allow linking to this file (actually the link can be created, but not used).

P — Make this a permanent file. A file cannot be deleted or renamed while it has this attribute.

R — Read protect this file. No one can read or copy it while it has this attribute.

W — Write protect this file. No one can modify this file while it has this attribute. (It can be deleted.)

S — Designate this a save (executable) file. You can deny execute access to a save file by removing its S attribute. If you remove it no one can execute the file.

Example Dialog

DIR SECONDPART)
R
CRAND TEST)
R
XFER/A/B \$TTI TEST)
THIS IS A TEST FILE)
{ctrl-Z}
R
TYPE TEST)
THIS IS A TEST FILE
R
CHATR TEST R)
R
TYPE TEST)
FILE READ PROTECTED: TEST
R
CHATR TEST +W)
R
XFER/A/B \$TTI TEST)
THIS IS LINE TWO)
FILE WRITE PROTECTED: TEST
R
CHATR TEST O)
R
XFER/A/B \$TTI TEST)
THIS IS LINE TWO)
{ctrl-Z}
R
TYPE TEST)
THIS IS A TEST FILE
THIS IS LINE TWO
R
CHATR TEST P)
R
DELETE/V TEST)
PERMANENT FILE: TEST
R

Changing a File's Link Access Attributes

CHLAT

Format — CHLAT filename₁ $\left\{ \begin{array}{c} + \\ - \end{array} \right\}$ attrib[...filename_n $\left\{ \begin{array}{c} + \\ - \end{array} \right\}$...attribs_n]

Function — Add or remove link access attributes to a resolution file. This controls the type of operations link users can perform on this file from other directories. To add an attribute, precede it with a plus sign (+); to remove an attribute, precede it with a minus sign (-); to remove all attributes enter a 0 as an argument; to retain all existing attributes use an asterisk (*).

Attributes

- N — Do not allow linking to this file (actually, the link can be created, but not used).
- P — Make this a permanent file. Link users cannot delete or rename a file while it has this attribute.
- R — Read-lock this file. Link users cannot read this file (but can execute it) while it has the R attribute.
- S — Designate this a save file.
- W — Write-lock this file. Link users cannot modify this file while it has the W attribute. (They can, however, delete it if they DELETE the link.)

Example Dialog

```

GDIR)
SECONDPART
R
CHLAT TEST RW)
R
TYPE TEST)
THIS IS A TEST FILE
THIS IS LINE TWO
R
DIR Dxx)
R
LINK TESTLK SECONDPART:TEST)
R
TYPE TESTLK)
FILE READ PROTECTED: TESTLK
R

```

Listing File Information

LIST

Format — LIST [*filename*]₁...*filename*_n

Function — List information from any directory about one or more of its files or link entries. This can include file size, access attributes, link access attributes, file creation date and time, date last opened, file starting address, and file use count. If you omit an argument, the system lists all nonpermanent files and link entries in the current directory. For link entries, link entry names, directory specifiers, and resolution file are listed. An @ precedes the resolution file if it is in the link directory's parent directory. The link access attributes, if any, are preceded by a slash (/).

Global Switches

- /A — List all files, permanent and nonpermanent.
- /B — List only the filenames.
- /C — List creation time (mo/day/yr/hr:min).
- /E — List all file information. (Overrides /B, /C, /F, /O, and /U.)
- /F — List logical address of first block in file, or if unassigned, list 0.
- /K — Do not list links.
- /L — List to line printer.
- /N — List links only.
- /O — List date file last opened (mo/day/yr).
- /S — Sort list alphabetically.
- /U — List file use count.

Local Switches

- /A — List only files created or modified this date or after. The argument has the form: mm-dd-yy; mm and dd can be one or two digits.
- /B — List only files created or modified before this date. The argument has the same form as local switch /A.
- /N — Do not list files matching this name.

Example Dialog

```
LIST/E TEST\
R
LIST/E/A TEST\
TEST      37      PD/RW      06/27/80  14:44      07/01/80      [002777]      0
```

Filename	Size in Bytes	Attributes/ Characteristics	Creation Date and Time, or Date and Time Last Modified	Date Last Opened	LBA	File Use Count
----------	---------------------	--------------------------------	---	------------------------	-----	----------------------

Listing All the Files in the Current Directory

```

R
LINK FILE3 SUBDIR:FILE3)
R
LINK FILE4/2)
R
LIST/S/E/A)
$LPT.          0 RAP      06/27/80  14:37  06/27/80  [000000]  1
$TTI.          0 APW      06/27/80  14:37  06/27/80  [000000]  1
$TTI1.         0 APW      06/27/80  14:37  06/27/80  [000000]  1
$TTO.          0 RAP      06/27/80  14:37  06/27/80  [000000]  1
$TTO1.         0 RAP      06/27/80  14:37  06/27/80  [000000]  1
$TTP.          0 RAP      06/27/80  14:37  06/27/80  [000000]  1
$TTP1.         0 RAP      06/27/80  14:37  06/27/80  [000000]  1
$TTR.          0 APW      06/27/80  14:37  06/27/80  [000000]  1
$TTR1.         0 APW      06/27/80  14:37  06/27/80  [000000]  1
COM.CM         26          06/27/80  14:45  06/27/80  [003002]  0
FILE2.         13          06/27/80  14:37  06/27/80  [002756]  0
FILE3.                SUBDIR:FILE3.
FILE4.                @:FILE4.
MAP.DR         62 APWC      06/27/80  14:36  06/27/80  [002742]  0
SUBDIR.DR     512 DY        06/27/80  14:40  06/27/80  [002757]  0
SYS.DR        20992 APWDY    06/27/80  14:36  07/01/80  [002731]  1
TEST.         37 PD/RW    06/27/80  14:44  07/01/80  [002777]  0
R

```

Filename Templates

A filename template may contain either or both of the following characters:

- Asterisk — represents any single character, except a period, in a filename or extension.
- Dash — represents any string of characters, except a period, in a filename or extension.

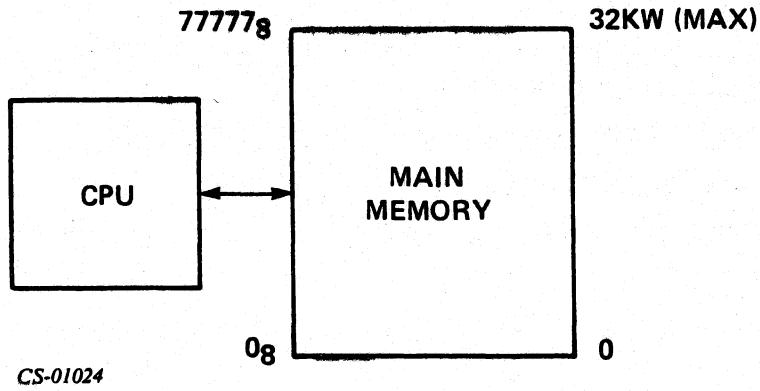

Figure 9.16 Standard Configuration

The Mapping Unit

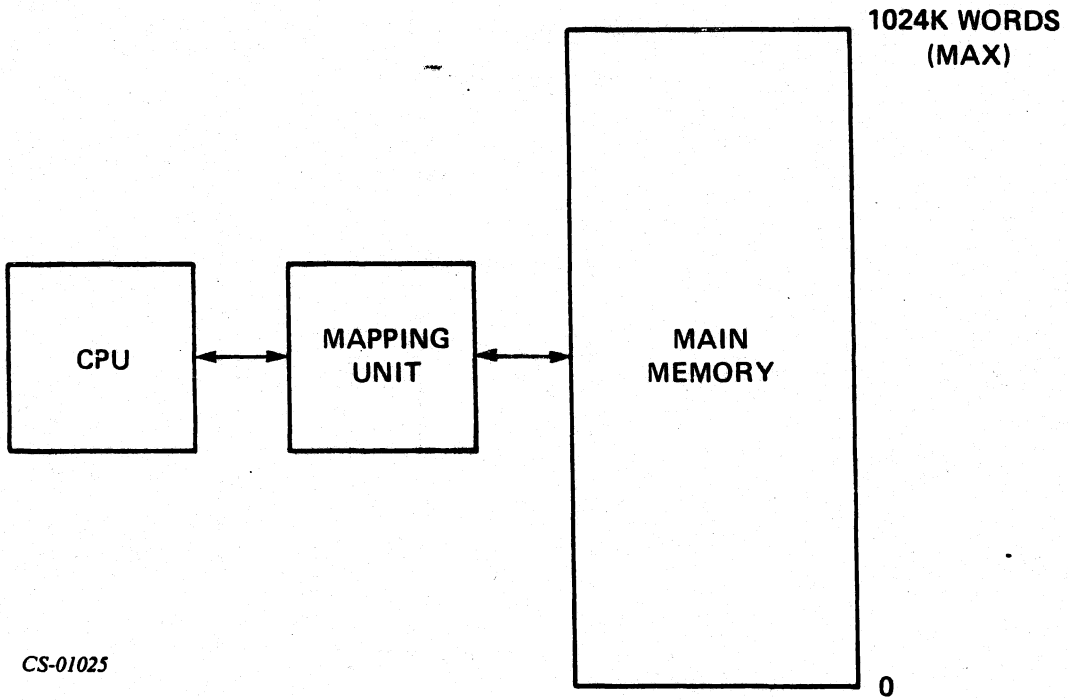

Figure 9.17 Configuration with a Mapping Unit

- NOVA Series — Memory Management and Protection Unit (MMPU)
- ECLIPSE Series — Memory Allocation and Protection Unit (MAP)

Map Terminology

- Address Space — The total number of memory addresses available to program. (Logical vs. Physical)
- Logical Address — The address used by the programmer.
- Logical Address Space — The total number of logical addresses. (32K)
- Physical Address Space — The actual amount of physical memory.

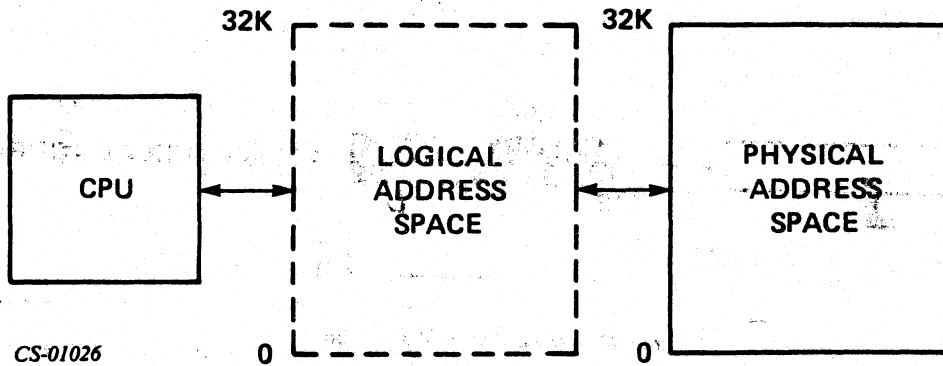

Figure 9.18 Unmapped

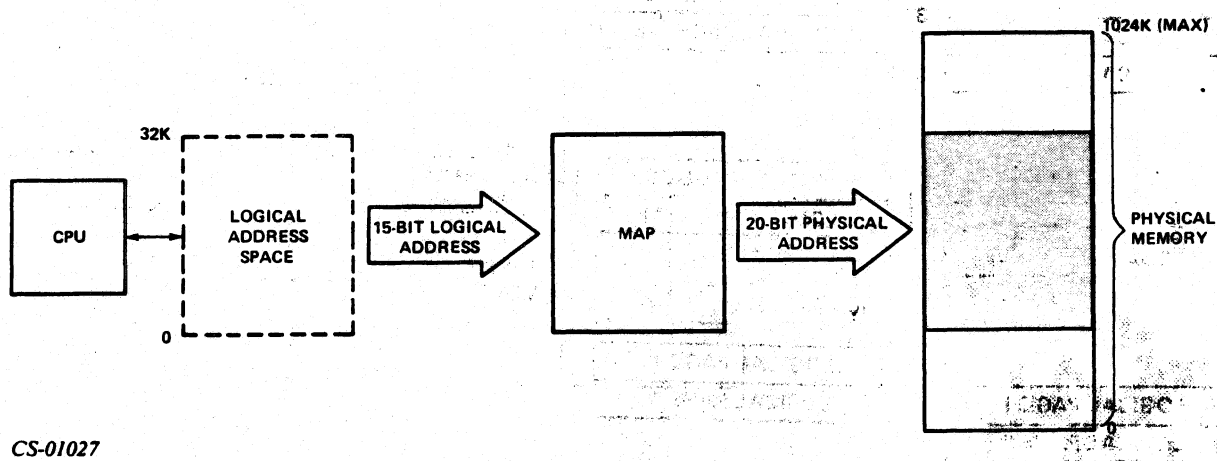
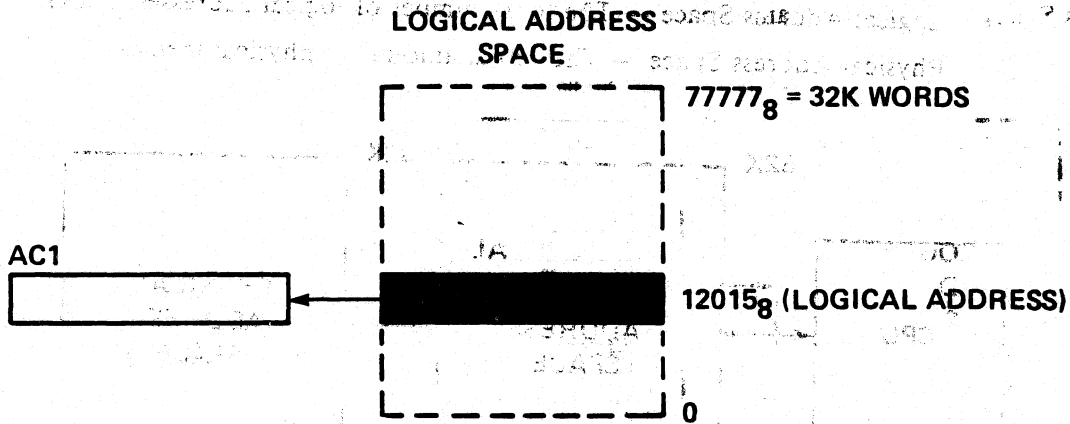

Figure 9.19 Mapped Configuration

Logical Address Calculation

The memory reference instruction LDA 1,12,2 means: Load accumulator 1 with the memory location pointed to by the value in accumulator 2, plus 12. If the contents of accumulator 2 is 12003_g, then the logical address is 12015_g.



CS-01028

Figure 9.20 Logical Address Calculation

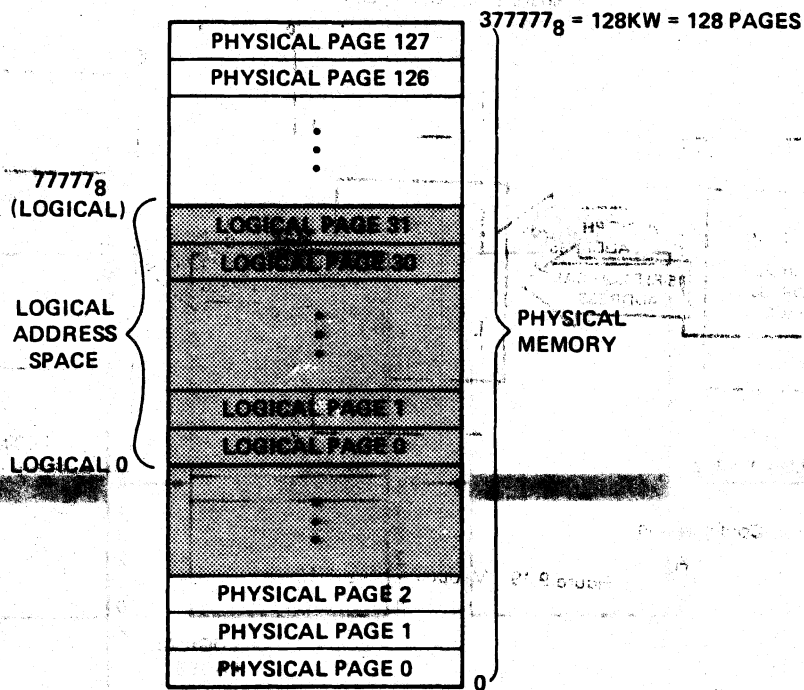

1 PAGE = 1K WORDS

CS-01029

Figure 9.21 Logical vs. Physical Address Space

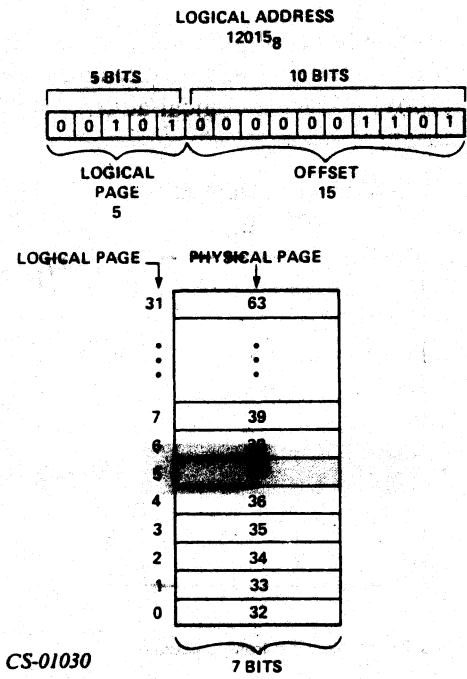
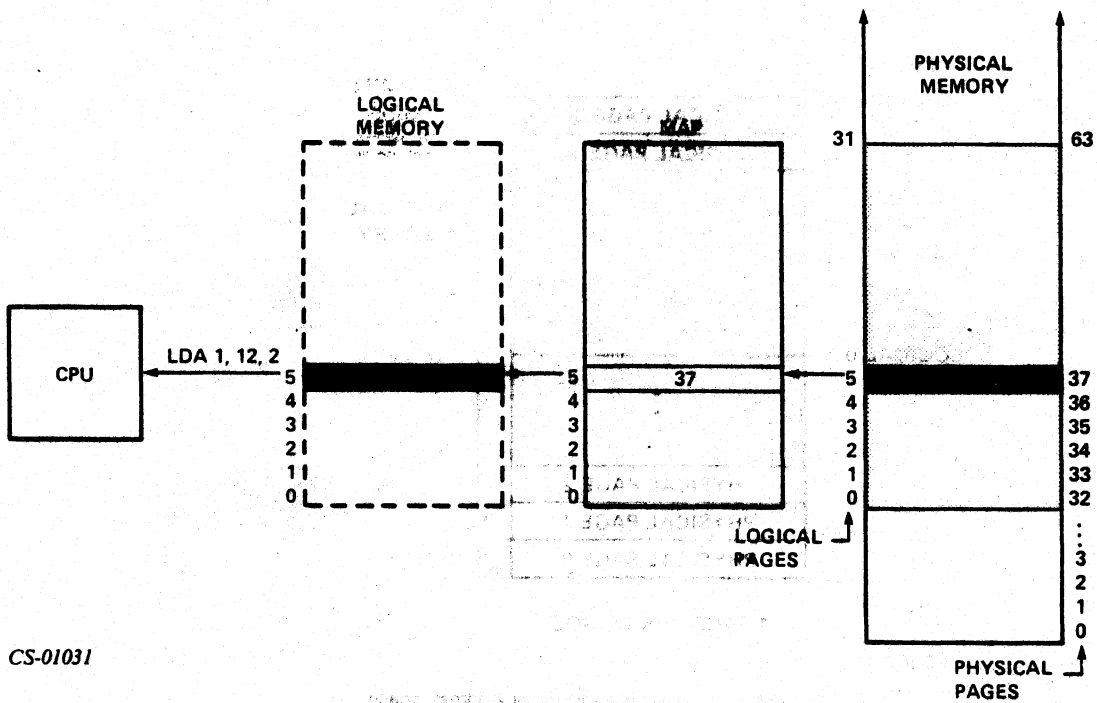

Figure 9.22 MAP Translation Table



CS-01031

Figure 9.23 Effect of MAP Translation

A. ONE SET OF VALUES IN THE MAP TABLE

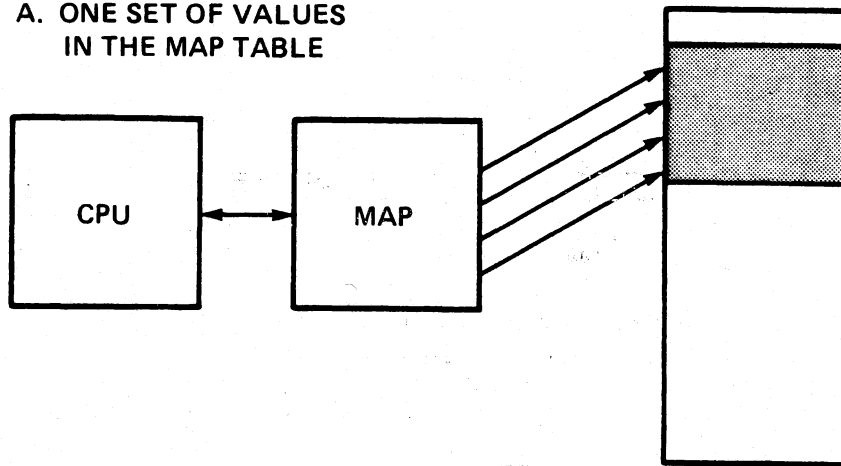

B. CHANGE VALUES IN THE MAP TABLE

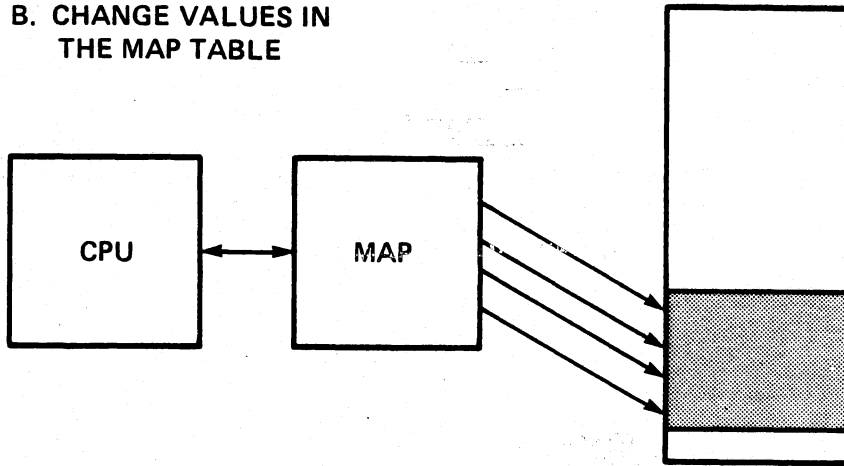

C. CHANGE SOME OF THE VALUES IN THE MAP TABLE

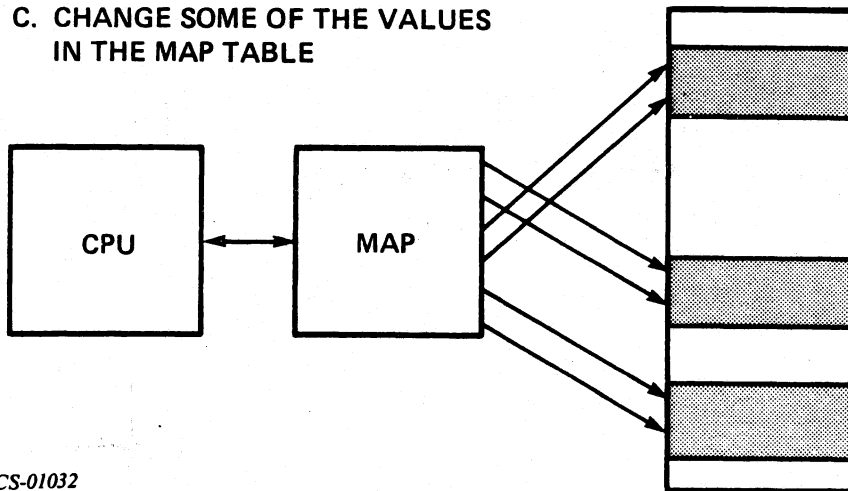

CS-01032

Figure 9.24 Remapping

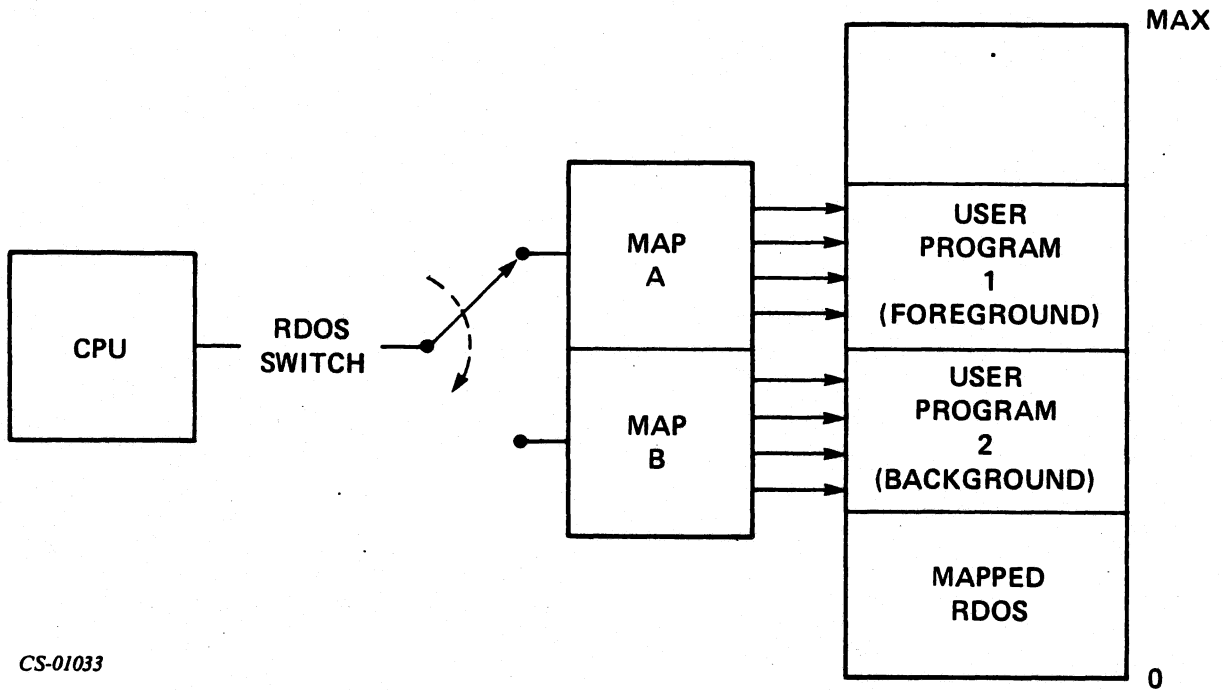

CS-01033

Figure 9.25 MAP A and MAP B

Module 9

Exercise 2

Match the following terms with their correct meaning.

- a. MPMU
 - b. MAP
 - c. Logical Address
 - d. Logical Address Space
 - e. Physical Address Space
 - f. Remap
1. _____ The actual amount of memory in a computer configuration.
 2. _____ The name of the mapping unit in ECLIPSE computers.
 3. _____ A change in the values in the MAP table.
 4. _____ The total amount of space available to a program.
 5. _____ The addresses used by a programmer.
 6. _____ The name of the mapping unit in NOVA computers.

Module 9

Exercise 2 Answers

1. e
2. b
3. f
4. d
5. c
6. a

Memory Management in a Mapped RDOS System

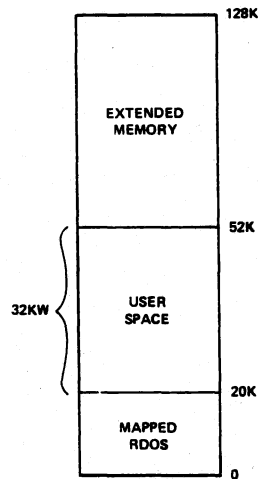

CS-01134

Figure 9.26 Extended Memory

Techniques for Using Extended Memory

- Virtual Overlays — Hold executable code in extended memory, then logically load it into user space.
- Window Mapping — Hold data in extended memory, then logically load it into user space.

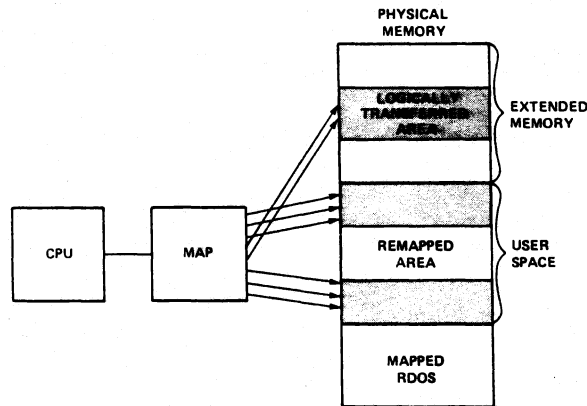

LOGICAL TRANSFER: ADDRESSES OF DATA ARE CHANGED. NO DATA IS ACTUALLY TRANSFERRED.

CS-01135

Figure 9.27 Logical Transfers

Virtual Overlays

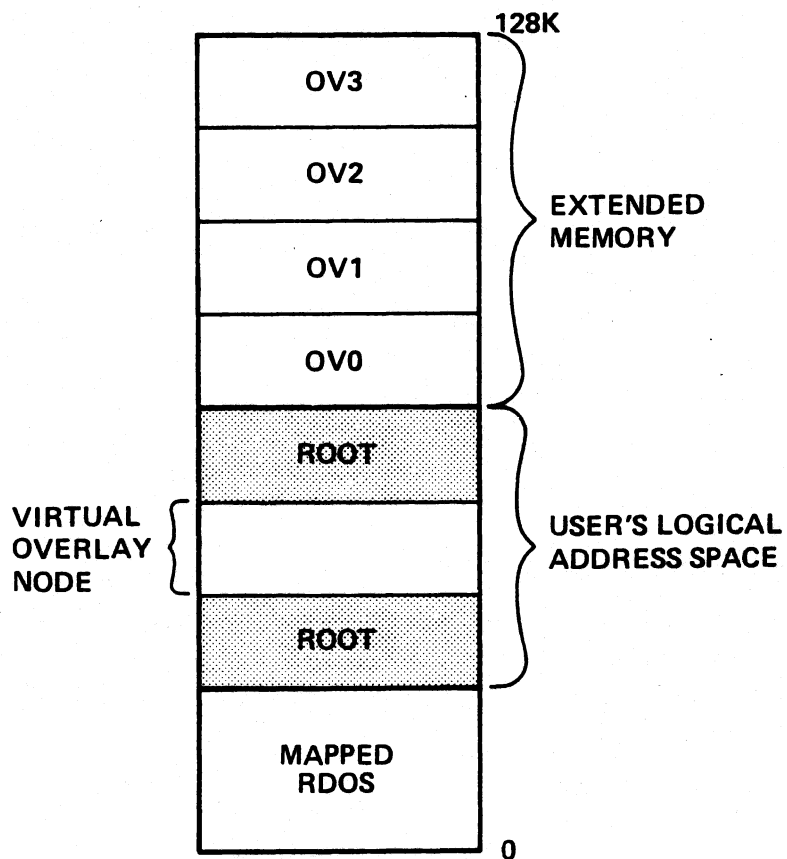

RLDR ROOT [OV0, OV1, OV2, OV3] / V

CS-01136

Figure 9.28 Virtual Overlay Memory Layout

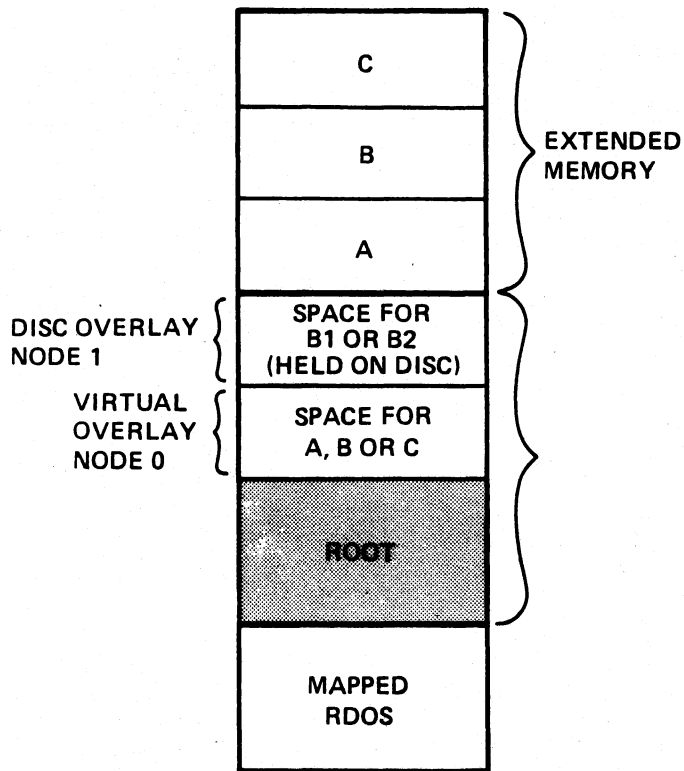
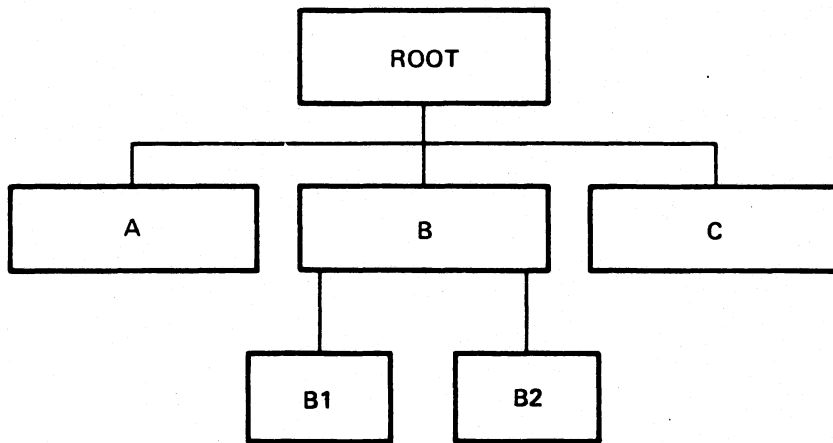

RLDR ROOT [A,B,C] /V [B1,B2]

CS-01137

Figure 9.29 Disc and Virtual Overlays Combined

Window Mapping

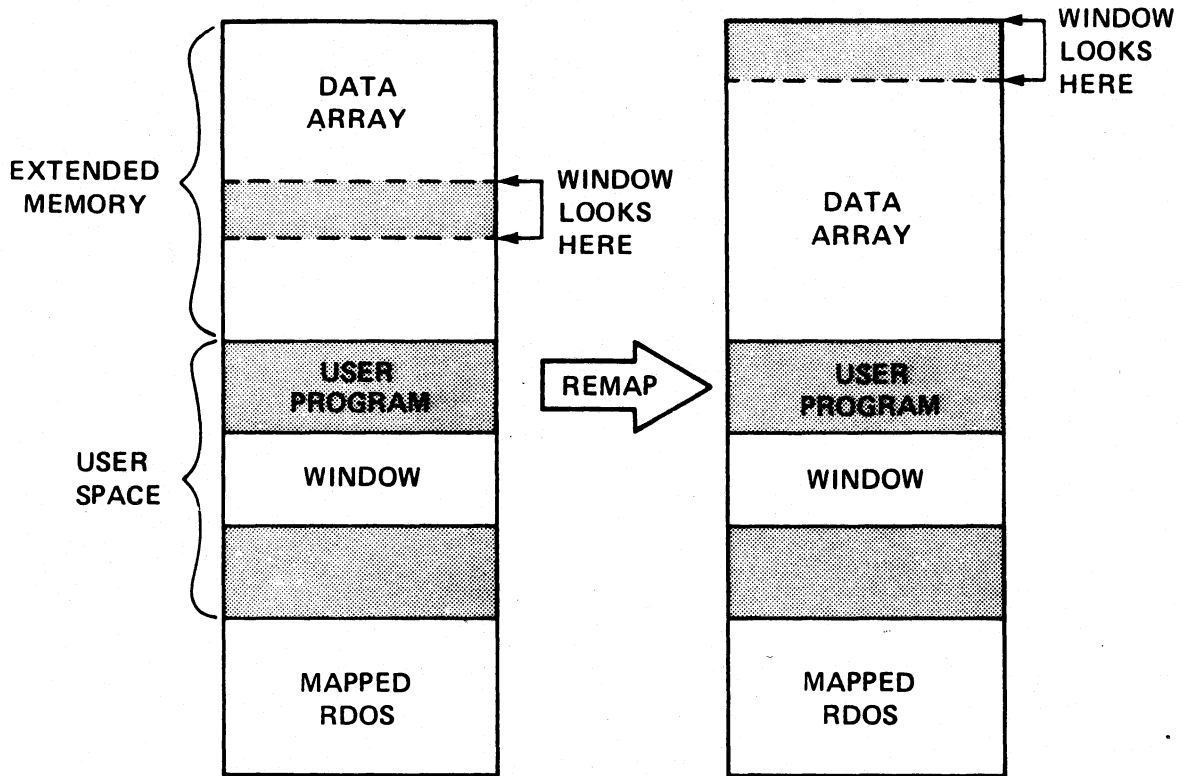

CS-01138

Figure 9.30 Window Remapping

Memory Protection

MAP Features

- MAP's main function: Address Translation
- Memory Protection Features:
 1. I/O Instruction Protection: Prohibits machine level I/O when MAP A or MAP B is enabled; causes a TRAP.
 2. Address Validity Protection: Prohibits memory references outside the range of valid addresses; causes a TRAP.

Module 9 Quiz

In Questions 1 through 5, *one* or *more* answers may be correct.

1. Which of the following are characteristics of chaining?
 - a. Program segments must be serially executable.
 - b. One segment is always memory resident during execution.
 - c. Shared data must be stored on disc.
 - d. Each segment overwrites the segment currently in memory.
2. Which of the following are characteristics of swapping?
 - a. Program segments must be serially executable.
 - b. Shared data must be stored on disc.
 - c. One segment controls the loading of all the others.
 - d. The memory image of the calling program is saved on disc during execution.
3. Which of the following are characteristics of overlays?
 - a. Each segment is processed separately by a translator and then integrated by RLDR.
 - b. One segment is always memory resident during execution.
 - c. Overlays are loaded into memory nodes.
 - d. Program segments must be serially executable.
4. Which of the following are characteristics of virtual overlays?
 - a. Extended memory is used to hold executable code.
 - b. Virtual overlays are logically transferred to user space by remapping.
 - c. The code in a program written for disc overlays need not be changed to be used with virtual overlays.
 - d. Virtual overlays are not actually transferred to memory nodes.
5. Which of the following are characteristics of window mapping?
 - a. Data is stored in extended memory.
 - b. Data is actually transferred to user space.
 - c. Access to extended memory is accomplished by a remap.
 - d. During execution, the program controls where in memory the window looks.

Identify which of the following characteristics correctly describes the program created by the following RLDR command by answering questions 6 through 12 as either *true* or *false*.

RLDR YEAR [SPRING,SUMMER,WINTER]/V [FALL]

6. _____ The main program's disc filename is YEAR.SV.
7. _____ Two overlay files, SPRING.OL and FALL.OL are created.
8. _____ SPRING, SUMMER and WINTER are held in extended memory.
9. _____ There are two memory nodes.
10. _____ SPRING, SUMMER, WINTER and FALL all share a node.
11. _____ Access to code in SPRING is faster than access to code in FALL.
12. _____ FALL is stored on disc.
13. Assume that a logical address is in page 3 at offset 2. Given the following MAP table, what would the physical address be?

Physical Address Page _____ , offset _____ .

31	95
	• • •
3	67
2	66
1	65
0	64

CS-01139

Figure 9.31 MAP Table

Complete the following sentences:

14. The actual amount of physical memory in a computer is referred to as _____ address space.
15. When you write a program, reference memory by using _____ addresses.
16. The total amount of address space available to a program is called _____ address space.
- 17., Changing the values in a MAP table is referred to as _____;
18. data transferred this way is said to be _____ transferred.
19. The mapping unit in a NOVA computer is called _____.
20. The mapping unit in an ECLIPSE computer is called _____.
21. The area of memory that receives an overlay is called _____.
22. The area of memory that is beyond the user's logical address space is called _____.

List two memory protection features of the MAP.

23. _____
24. _____

Check your answers with those given in *Appendix A: Quiz Answers*. Score one point for each correct answer. The maximum score is 24 points. Mastery level is 20 points. If you achieve the mastery level, proceed to Module 10. Otherwise, review the material presented in this module before continuing.

Module 10

Dual Programming

Introduction

RDOS is a dual-programming operating system. This means that two programs can coexist in memory and appear to execute simultaneously, while RDOS apportions CPU time and disc I/O time between them. In this way, the hardware resources of the computer system can be utilized more efficiently. It is possible to have dual programming in a system that has a mapping unit, as well as in one that does not. The setup for each environment is different. This module concentrates on mapped dual-programming systems, but also describes an unmapped environment.

Learning Objectives

Upon successful completion of this module you will be able to:

1. Identify the characteristics of a mapped dual-programming system.
2. Identify the characteristics of an unmapped dual-programming system.
3. Name the CLI commands that perform the following functions:
 - Display memory allocation
 - Divide memory into foreground and background regions
 - Execute a program in foreground
 - Display whether or not a program is running in foreground
 - Terminate a foreground program
4. In a system configured with a secondary interactive terminal running CLI, give the reserved filenames for the second terminal's input and output portions, and the foreground's logfile.

Resources

1. RDOS Student Guide, Module 10
2. Audiocassette tape for Module 10

Module Outline

1. Dual-Programming Concepts
2. Dual Programming in a Mapped System
 - a. CLI Commands
 - b. Memory Allocation
3. Dual Programming in an Unmapped System
4. Module Quiz

Directions

Turn to Figure 10.1 and listen to the audiocassette tape for Module 10.

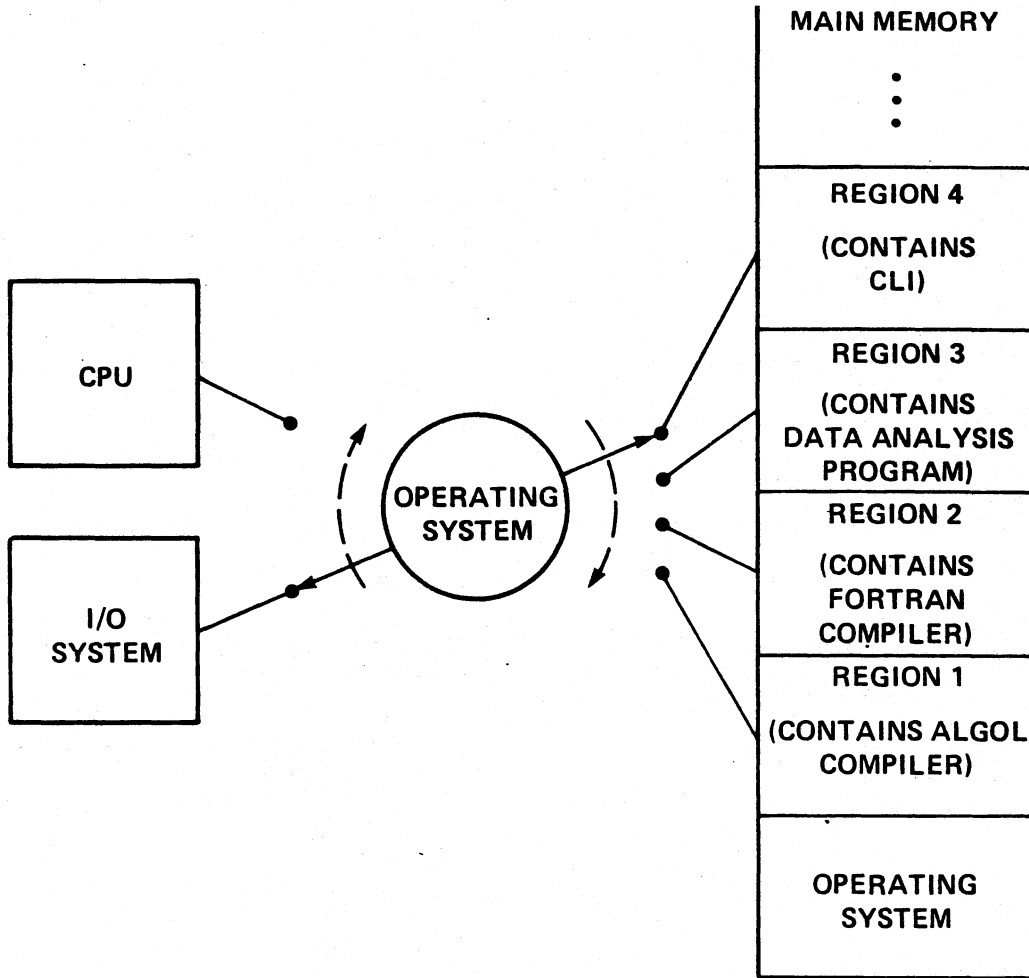

CS-01140

Figure 10.1 Multi-Programming Operating System

Dual-Programming Concepts

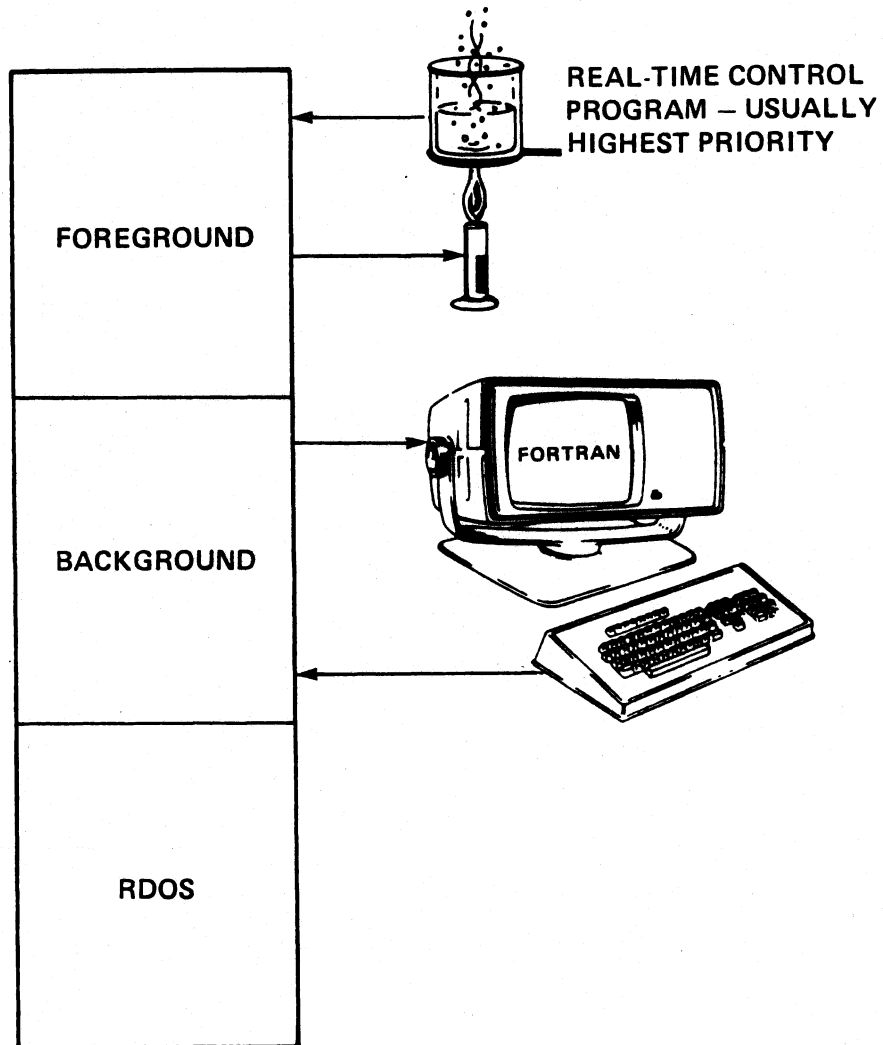

CS-01141

Figure 10.2 Dual-Programming Operating System (RDOS)

Dual Programming on a Mapped System

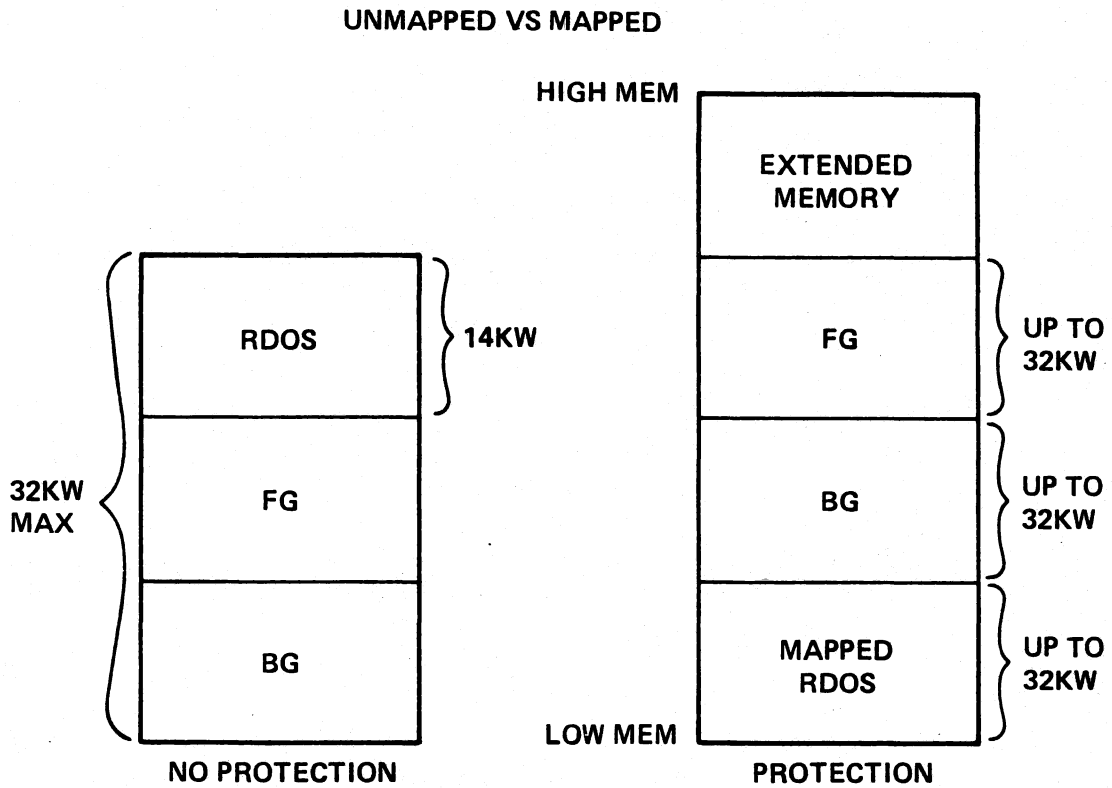

CS-01142

Figure 10.3 Memory Layout for Mapped and Unmapped Systems

CLI Commands for Dual Programming

GMEM (mapped RDOS only)

Format — GMEM

Function — Display the current memory allotment to background and foreground regions. The size is given in pages (1,024 words).

SMEM (mapped RDOS only)

Format — SMEM background-pages

Function — Set the amount of memory that is available to the background program; the foreground program will receive the remainder. When you boot RDOS, it gives all available memory to the background. Enter the number of decimal pages you want for background.

EXFG

Format — EXFG savefilename

Function — Execute a savefile in foreground. You must have established foreground memory with the SMEM command.

Global Switch

/E — Give foreground and background equal priority (by default, foreground has priority).

FGND

Format — FGND

Function — Describe whether or not a foreground program is running. FGND returns one of two messages: *NO FOREGROUND PROGRAM RUNNING* or *FOREGROUND PROGRAM RUNNING*.

CONTROL SEQUENCE: CTRL-F

Function — Terminate the program running in foreground.

Example of Dual-Programming Dialog

A. .
 . (Bootstrap)
 .
 GMEM ↓
 BG: 234 FG: 0
 R

B. SMEM 32 ↓
 R
 GMEM ↓
 BG: 32 FG:202
 R
 FGND ↓
 NO FOREGROUND PROGRAM RUNNING
 R

C. EXFG/E CLI.SV ↓
 R
 FGND ↓
 FOREGROUND PROGRAM RUNNING
 R

D. {ctrl-F }
 FG TERM ↓
 FGND ↓
 NO FOREGROUND PROGRAM RUNNING
 R

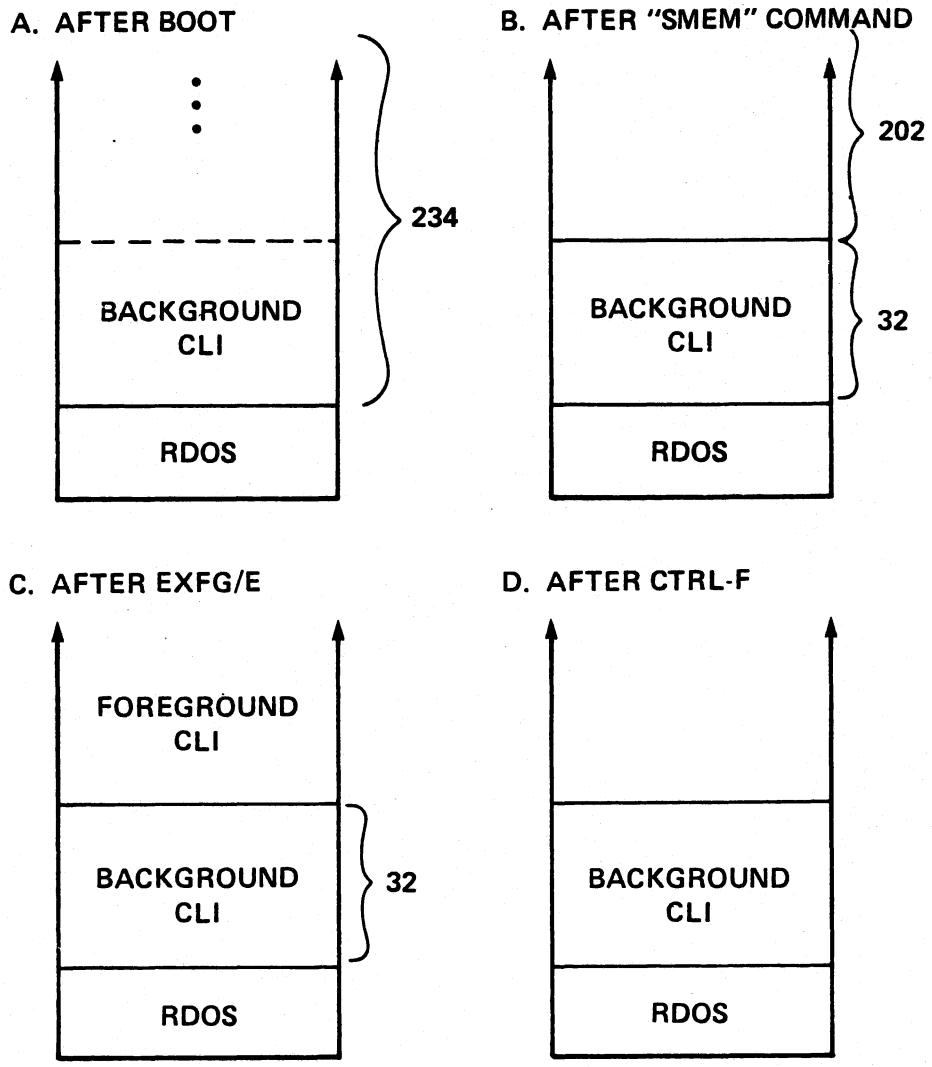

CS-01143

Figure 10.4 Mapped FG/BG Usage

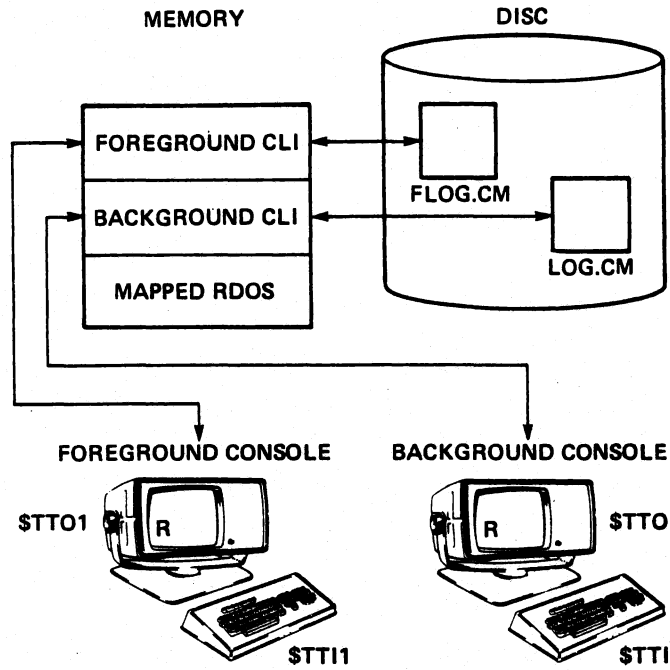

CS-01144

Figure 10.5 CLI in Foreground and Background

- Foreground is a separate User Program in High Memory.
- Background is a separate User Program in Lower Memory.
- Each communicates via the CLI to their respective consoles.
- RDOS preserves all facilities for both programs.

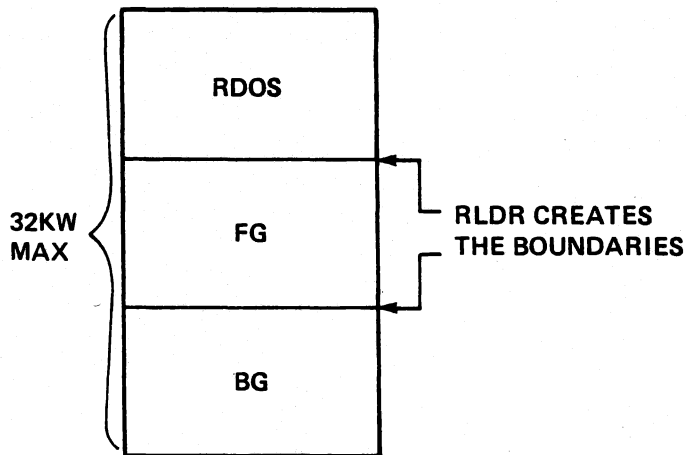

CS-01145

Figure 10.6 Dual Programming in an Unmapped Machine

Module 10 Quiz

In Questions 1 through 5, identify the characteristics of a **mapped** dual-programming system by answering *true* or *false*.

1. _____ A program developed for background can be executed in the foreground without any modification to the program code.
2. _____ The grounds are protected from one another by a hardware boundary.
3. _____ When RDOS is booted, all memory is allocated to the foreground.
4. _____ Before executing a program in foreground, you must allocate foreground memory.
5. _____ A program developed for the background must be reprocessed by the RLDR before it can be executed in the foreground.

In Questions 6 through 10, identify the characteristics of an **unmapped** dual-programming system by answering *true* or *false*.

6. _____ A program developed for background can be executed in the foreground without any modification to the program code.
7. _____ The grounds are protected from one another by a hardware boundary.
8. _____ When RDOS is booted, all memory is allocated to the foreground.
9. _____ Maximum memory space of 32K words must be shared by RDOS, the background, and the foreground.
10. _____ A program developed for the background must be reprocessed by the RLDR before it can be executed in the foreground.

In Questions 11 through 15, write the CLI command that performs the corresponding function.

11. Display memory allocation. _____
12. Divide memory into foreground and background regions. _____
13. Execute a program in the foreground. _____
14. Display whether or not a program is running in FG. _____
15. Terminate a foreground program. _____

In a system configured with a secondary interactive terminal that is running CLI, give the reserved filename for the following devices and file.

16. The second terminal's keyboard. _____
17. The second terminal's display. _____
18. The foreground's logfile. _____

Check your answers with those given in *Appendix A: Quiz Answers*. Score one point for each correct answer. The maximum score is 18 points. Mastery level is 15 points. If you achieve the mastery level, proceed to Module 11. Otherwise, review the material presented in this module before continuing.

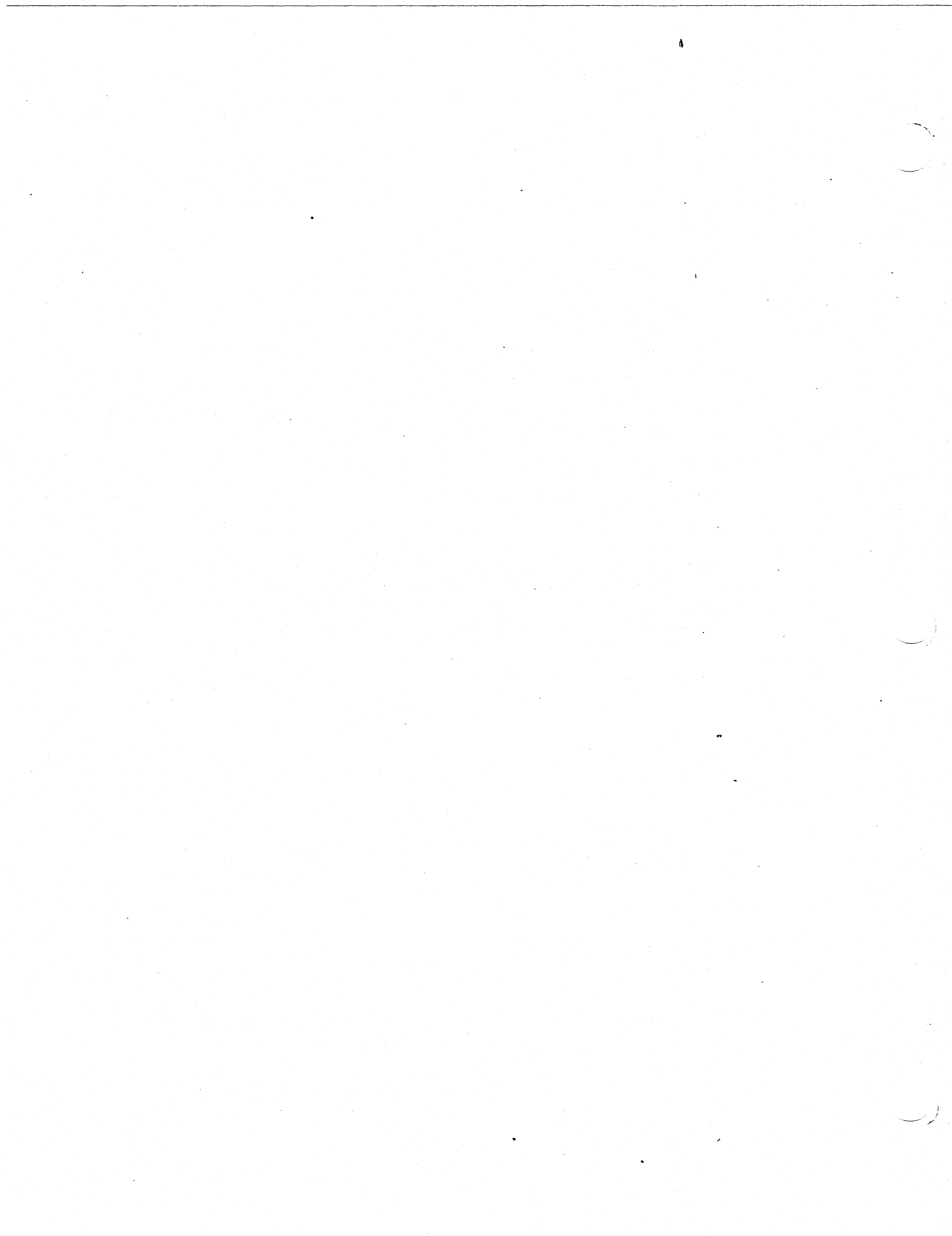

Module 11

System Generation and Maintenance

Introduction

In any computer installation, individual users often need different hardware or software support for their programs. Moreover, the configuration and scope of a project at a given installation may change over time. Ideally, each installation should have several RDOS operating systems, each tailored to a specific type of application. The procedure that allows you to generate a tailored RDOS system is called System Generation. The first part of this module describes System Generation concepts and procedures.

Once a system has been generated, certain procedures should be followed to ensure efficient and trouble-free operation. In the second part of this module you will see how to improve RDOS's efficiency, how to back up discs, and how to treat system failures.

Learning Objectives

Upon successful completion of this module you will be able to:

1. List the six major steps involved in the installation of a tailored RDOS system.
2. Given an example configuration, answer selected questions concerning the installation of an RDOS system tailored to that configuration.
3. Distinguish among the four types of files created by the System Generation program.
4. List the three types of multiplexors supported by RDOS.
5. Distinguish among Direct Block I/O, Buffered I/O, and SPOOLING.
6. Distinguish among a Trap, an Exceptional Status Failure, and a Crash.
7. Distinguish among the utilities BURST, DBURST, and OWNER.

8. Identify the meaning of the following terms:

SYSGEN

Update

Tuning

Tuning Report

Starter System

System Stacks

System Buffers

System Cells

System Fault

System Call

System Task

Core Dump

Software Trouble Report

Primary Console

Secondary Console

9. Identify the CLI commands that perform the following functions:

Perform system generation

Stop spooling

Disable spooling

Enable spooling

Turn tuning on

Turn tuning off

Print the tuning report

Clear a file's use count

Resources

1. RDOS Student Guide, Module 11
2. Audiocassette tape for Module 11

Module Outline

1. Installation and Generation
 - a. Concepts
 - Configurations
 - I/O Requests
 - Tuning
 - b. Exercise 1
 - c. Starter System Installation
 - Magnetic Tape
 - Diskette
 - d. System Generation
 - e. Updates
 - f. Exercise 2
2. Maintenance
 - a. Tuning
 - b. System Abnormalities
 - c. Disc Backup
3. Lab Exercise
4. Module Quiz

Directions

Turn to the section *Software Release* beginning on the next page, and start the audiocassette tape for Module 11.

Software Release

RDOS Flavors

- URDOS Unmapped NOVA
- MRDOS Mapped NOVA
- NRDOS Mapped NOVA 3 or NOVA 4
- BRDOS Unmapped ECLIPSE
- ARDOS Mapped ECLIPSE (S200 or C300)
- ZRDOS Mapped ECLIPSE (Any other ECLIPSE)

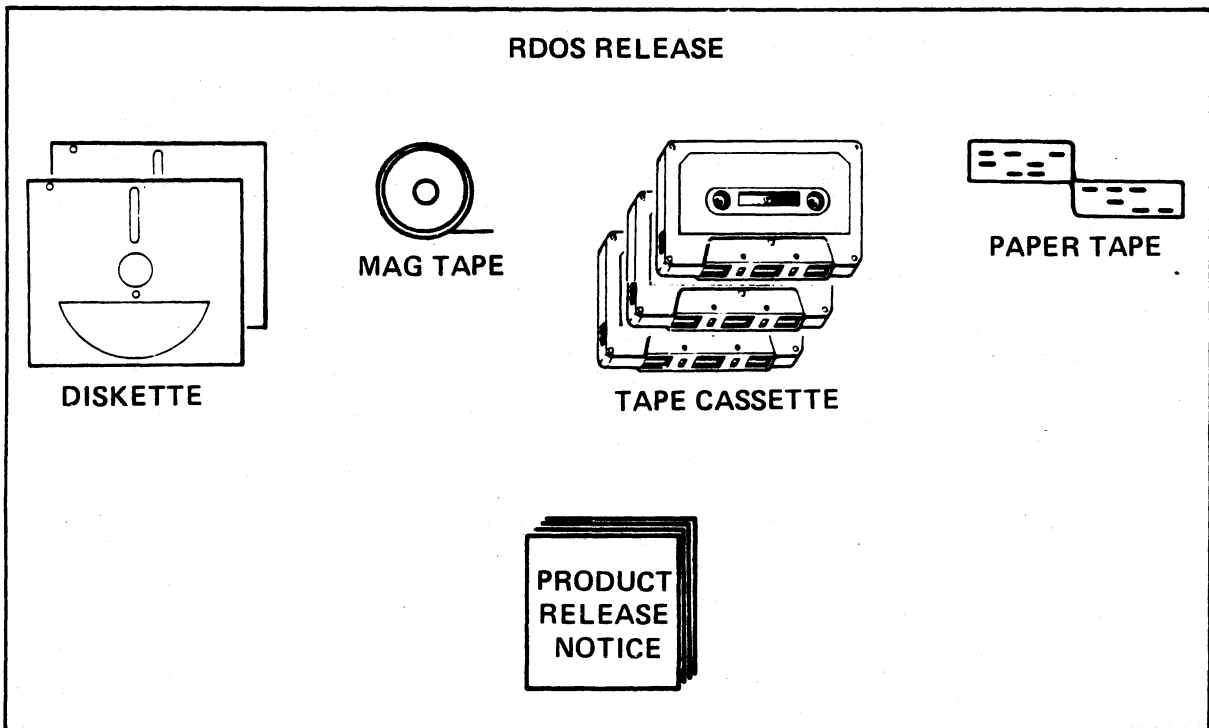

CS-00935

Figure 11.1 Software Release

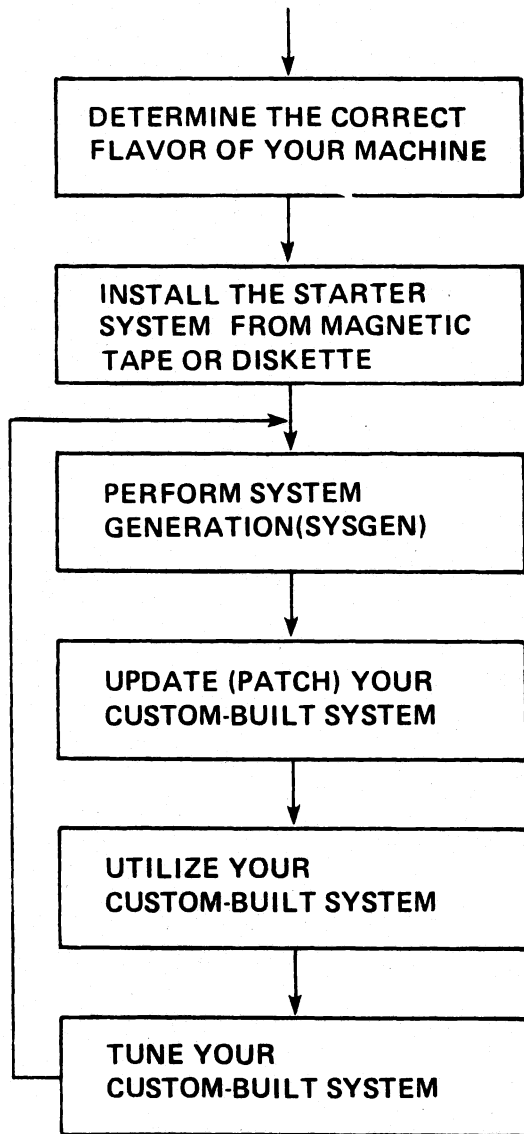

CS-00936

Figure 11.2 Installation of a Tailored System

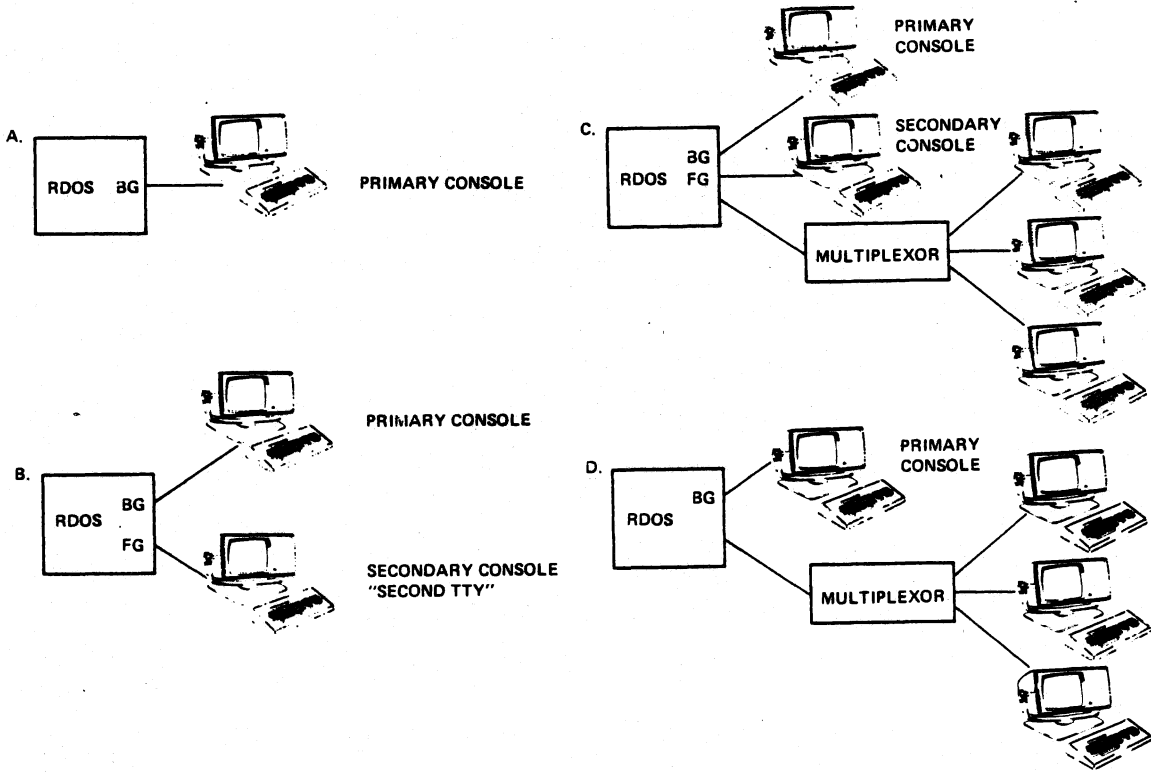

CS-01146

Figure 11.3 Interactive Terminal Configurations

Multiplexors

Table 11.A Multiplexors

Model Number	Name	Mnemonic	Device Codes		Supports
			Primary	Secondary	
4255-4258	Asynchronous Line Multiplexor	ALM	34	74	1-64 full- or half-duplex lines
4060-4063	Asynchronous Communications Multiplexor	QTY	30	70	
	Universal Line Multiplexor	ULM	34	74	16 half-duplex asynch lines or 8 full-duplex asynch lines and/or 2 synchronous lines

- Half-duplex — Data flows in only one direction at a time.
- Full-duplex — Data flows in two directions simultaneously.
- Each ALM, QTY, or ULM line is a filename in the form of:
 QTY: xx (Primary Controller)
 QTY1: xx (Secondary Controller)
 where xx: 0 . . 63
- Modem — A device that allows the transmission of data over long distances. (See Appendix D.)

UNBUFFERED (DIRECT BLOCK I/O)

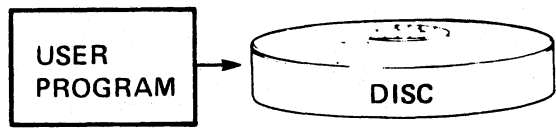

BUFFERED I/O

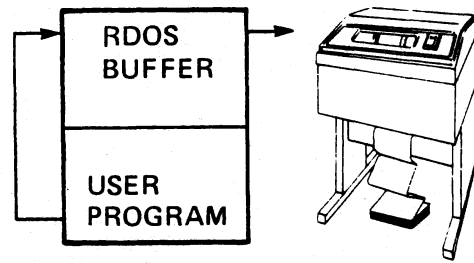

SPOOLING

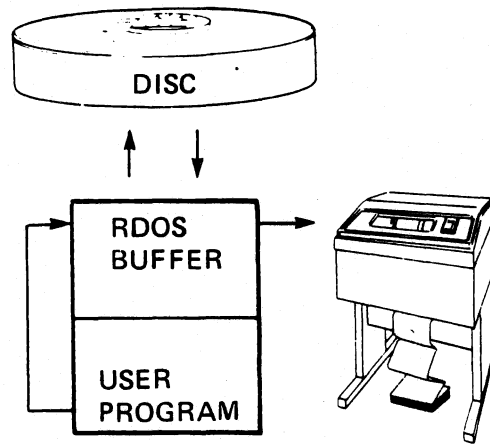

CS-01147

Figure 11.4 RDOS I/O Requests

CLI Spooling Commands

SPKILL

Format — SPKILL devicename₁. . .

Function — Delete the spool queue to devicename(s). Spooling resumes at the next command to the device.

Example — SPKILL \$LPT)

Stop spooling data to the line printer. Data on the output spool is lost.

SPDIS

Format — SPDIS devicename₁. . .

Function — Disable spooling on one or more spoolable devices. Normally, the spooling is enabled to the following device names: \$DP0, \$LPT, \$LPT1, \$PTP, \$PTP1, \$TTO, \$TTO1, \$TTP, and \$TTP1. You can disable spooling on any of these by entering its device name in an SPDIS command. The plotter (\$PLT, \$PLT1) is spoolable, but is initially spool-disabled.

Example — SPDIS \$LPT)

Disable spooling to the line printer. If output is currently being spooled to the device, the command takes effect after the current spool is completed.

SPEBL

Format — SPEBL devicename₁. . .

Function — Enable spooling on a spoolable device.

Example — SPEBL \$LPT)

Resume spooling data output to the line printer.

The Tuning Feature

Tuning — Allows RDOS to monitor its own performance and suggest a more efficient system.

Stacks, Cells, Buffers — Memory resident software data structures.

Tuning Report — Results of efficiency test are stored here.

Fault — Request for system resource that cannot be granted because the resource is not available.

System Stacks

System Call — A request to RDOS for use of its resources. Like a subroutine call, except that the called routine is part of RDOS instead of your program.

System Task — The execution path of the set of instructions generated by a system call; RDOS can service several system calls in parallel.

System Stack — A data base used by RDOS to service each system task; one stack per concurrent system task.

Example

Two users concurrently issue system calls.

Two system tasks are outstanding.

To service both tasks in parallel, RDOS needs two stacks.

Table 11.B System Stack Requirements

System	System Stacks	
	Minimum	Recommended
Unmapped	1	2*
Mapped	2	3*
Extended BASIC unmapped	2	4 or more
Extended BASIC mapped	3	5 or more

*Plus one additional stack for every task that will be running concurrently.

System Cells

System Cell — A table that RDOS uses to save information about the state of system tasks. They are also used for temporary data storage.

SYSGEN automatically allots three cells for each stack.

Recommended Extra Cells

Two extra cells for each active SPOOL request (except for system console).

One extra cell for each active system call.

A. ADEQUATE CELL APPORTIONMENT

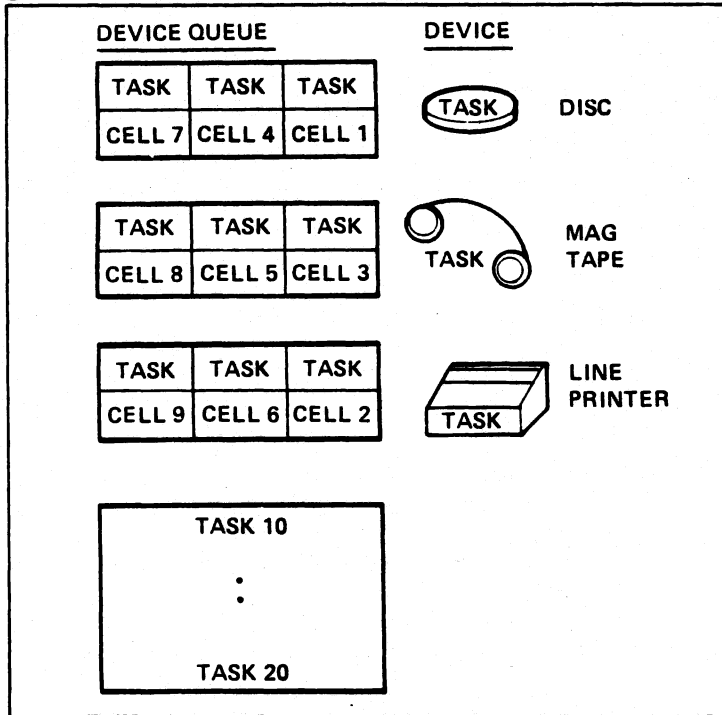

B. INADEQUATE CELL APPORTIONMENT

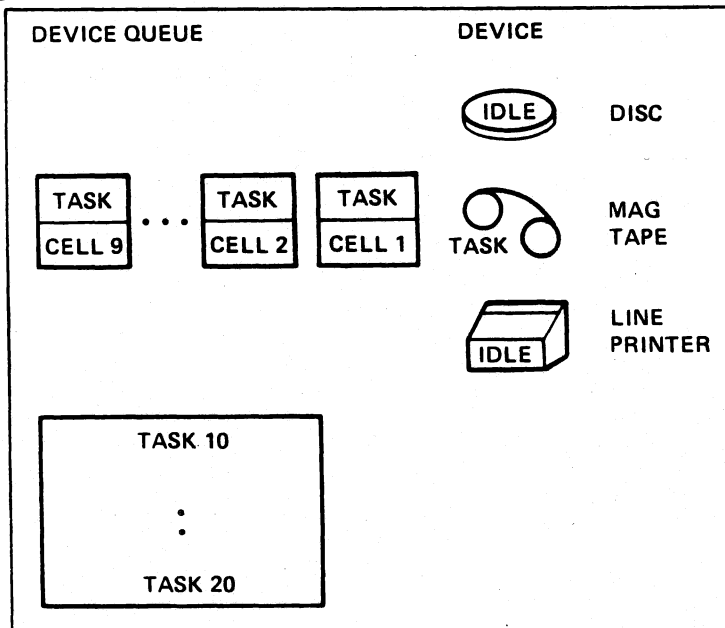

CS-01148

Figure 11.5 Cell Apportionment

System Buffers

System Buffer

- Receives system overlays.
- Buffers I/O operations (temporary storage).
- SYSGEN automatically allots a minimum of six buffers or two per stack, whichever is greater.

Additional Buffers

- Extra buffers increase speed, decrease memory.
- Guidelines.

Table 11.C Buffer Guidelines

Memory Size	Extra Buffers
20K	0
24K	4
32K or more	8

Module 11

Exercise 1

1. Below are the six major steps involved in installing a custom-built RDOS system. Number the steps in the correct order.

- _____ Perform system generation.
- _____ Utilize your custom-built system.
- _____ Install the starter system.
- _____ Tune the system.
- _____ Determine the correct RDOS flavor.
- _____ Update your system.

True or False?

- 2. _____ The RDOS starter system supports all devices on any hardware configuration that supports RDOS.
- 3. _____ In a hardware configuration that includes two consoles, one console, called the primary console, usually operates in the background; the other, called the secondary console, operates in the foreground.
- 4. _____ The three multiplexors supported by RDOS are: ALM, QTY, ULM.
- 5. _____ With SPOOLed I/O, data is transferred directly between memory and a line printer.
- 6. _____ A system call is a request to RDOS for the use of its resources.
- 7. _____ A system task is the execution path of the set of instructions generated by a system call.
- 8. _____ RDOS uses system cells and system stacks to service system tasks.
- 9. _____ A system buffer is an area in main memory that holds system overlays.

Module 11

Exercise 1 Answers

1. 3 Perform system generation.
5 Utilize your custom-built system.
2 Install the starter system.
6 Tune the system.
1 Determine the correct RDOS flavor.
4 Update your system.
2. False
3. True
4. True
5. False
6. True
7. True
8. True
9. True

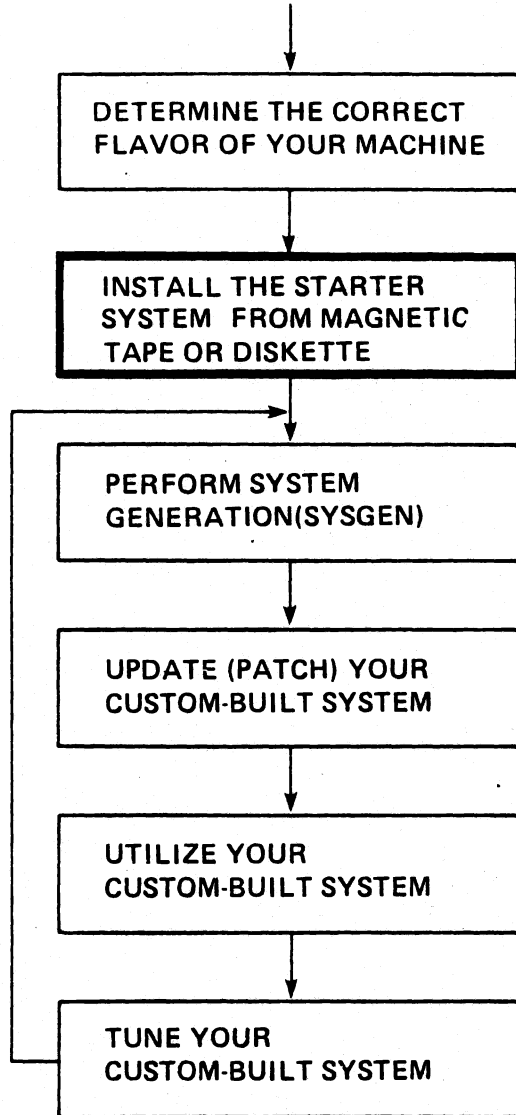

CS-01149

Figure 11.6 Installation of a Tailored RDOS System

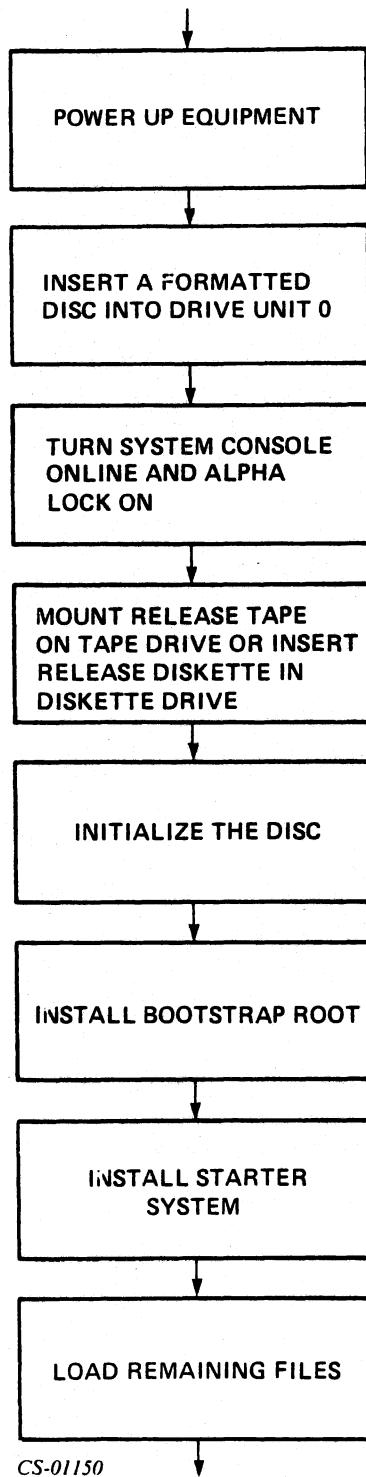

Figure 11.7 Installing the Starter System

Where Do I Go from Here?

1. Load the Starter System. Read either *a.* or *b.*
 - a. *Loading the RDOS Starter System from Magnetic Tape*, beginning on page 11-18.
 - b. *Loading the RDOS Starter System from Diskette*, beginning on page 11-29.
2. Read *Building a Tailored RDOS System*, beginning on page 11-46.
3. Read *Updating Your Tailored System*, beginning on page 11-63.
4. Do Exercise 2 that follows the section, *Updating Your Tailored System*.

Stop the audiocassette tape now, and read the text. Do the exercise as instructed.

Loading the RDOS Starter System from Magnetic Tape

The RDOS Tape

When you receive your RDOS system on magnetic tape, Data General supplies a tape with eight or more files. Each of these tape files (described in Table 11.D) has one or more programs in it. If you received the INFOS file system (commercial ECLIPSE systems only), your tape has more than eight files; you'll be using them as described below.

INFOS system generation is beyond the scope of this course. If you have an RDOS-INFOS system, follow the directions in the Data General publication *How to Load and Generate Your RDOS System*, (093-000188-02), and also the release notices supplied with the software.

Table 11.D RDOS Magnetic Tape File Structure

File Number	Program Names	File Contents
0	TBOOT.SV	A short program that you use to read in other files from this magnetic tape.
1	CLI.SV, CLI.OL, CLI.ER BOOT.SV BOOTSYS.SV	Programs that make up the RDOS Starter System (but are not readable by TBOOT.SV).
2	BOOTSYS.SV	The RDOS Starter System in a form that TBOOT.SV can read.
3	BOOTSYS.OL	
4	DKINIT.SV	A disc initializer program that you must run to prepare the disc before you put any RDOS system on it. TBOOT.SV can read this file.
5	BOOT.SV	This program installs a bootstrap loader on the disc, after which you can start up RDOS directly from the disc using the computer front panel switches. TBOOT.SV reads BOOT.SV.
6	RDOS Utilities	The appropriate utility programs for your license (assemblers, text editors, debuggers, etc.) are in this file. Load them onto the disc using the RDOS Starter System.
7	SYSGEN programs	Load these RDOS System Generation programs onto the disc using the RDOS Starter System; then execute them to generate your tailored RDOS system.
INFOS only		
8	INFOS Libraries and Parameter files	INFOS needs these language libraries and files.
9	INFOS Utilities	These programs help you work with INFOS.
10	Release Notice	Latest notes on your system, in machine-readable format.

Preliminary Steps

This section assumes that you have already performed the following preliminary steps:

- a. Your equipment is powered up.
- b. You've loaded a disc into disc drive unit 0 and the drive is ready.
- c. All your consoles are online and in ALPHA LOCK. (Actually, you will only be using the system console. To discover which console is the system console, power them all up and find the one that displays the messages described in the following steps.)

Program Load

As seen from the tape file organization, you have to read TBOOT.SV into the computer before you can read and execute any of the other programs from the magnetic tape. To do so:

1.
 - a. Remove the write-enable plastic ring from the tape, if this has not already been done. (This protects the tape from accidentally being written on.)
 - b. Select unit 0 on the tape drive you will use, and make sure that no other drive has the same number.
 - c. Mount and thread the tape.
2. Using the tape drive panel switches, LOAD the tape and set the unit ON LINE. The READY, WRITE LOCK, and BOT lights should be lit.
3. If your computer has a programmed console, go to Step 4. If it has numbered data switches and automatic program load, go to Step 5. If it has data switches and lacks automatic program load, go to Step 6.
4. The display terminal or printing system console should show a number and an exclamation point (!) prompt. (If not, flip the computer power switch OFF and ON.) Type:
100022L
on the system console and go to Step 7.
5. With hardware data switches and automatic program load, set the data switches to 100022g (switches 0, 11, and 14 up, the others down). Lift the RESET switch, then the PROGRAM LOAD switch. Go to Step 7. (On a SUPERNOVA, set the switches to 00022g, lift RESET, and press CHANNEL START.)

6. Without auto program load, you'll key a two-word program into the switches. Follow these steps (they are listed here, then you are referred to this section later).
 - a. Set the computer's front-panel data switches to 000376g (switches 8 through 14 up, others down).
 - b. On a NOVA 3 machine, lift the EXAMINE switch and hold it up. Verify that the lamps that are lit match the switches set in the up position. Release the switch. For other machines, lift the EXAMINE switch and verify that the lamps lit match the switches set.
 - c. Set the data switches to 060122g (switches 1, 2, 9, 11, and 14 up, others down).
 - d. On a NOVA 3 computer, lift the DEPOSIT switch and hold it up. Verify that the lamps lit match the switch settings, and release the switch. On other machines, lift the DEPOSIT switch. Verify that the pattern in the DATA lights matches the data switch setting.
 - e. Set the data switches to 000377g (switches 8 through 15 up, others down).
 - f. On a NOVA 3 machine, depress the DEPOSIT NEXT switch and hold it down; verify that the lamps lit match the switch settings, and release the switch. For other machines, depress the DEPOSIT NEXT switch. Verify that both the ADDRESS and DATA lights match the switch settings.
 - g. Set the data switches to 000376g (put down switch 15). Lift and release the RESET switch, then the START switch. You are now executing a two-word program that you just loaded into the computer's memory.
7. The computer now reads TBOOT.SV (the first file) from the magnetic tape, and executes the TBOOT.SV program. TBOOT.SV types out:

FROM MT0:

on the system console.

The Disc Initializer

After TBOOT.SV has typed

FROM MT0:

8. Type in your response, as shown in the following example:

4)

Pressing the RETURN key tells the computer to accept the value preceding the ") ". If you make a typing mistake while typing in an answer, but before pressing RETURN, press the DEL or RUBOUT key to erase the bad characters one by one. DKINIT echoes an underscore (_) for each character erased.

You have asked TBOOT to read and execute the tape file that holds DKINIT.SV, the Disc Initializer program. You'll see the tape moving as TBOOT.SV loads the file into the computer. TBOOT then directs the computer to execute DKINIT.SV.

DKINIT.SV types out:

*DISK INITIALIZER — REV xx (xx = revision number)
DISK DRIVE MODEL NUMBER?*

- It's asking you for the Data General model number of your disc drive. Type in the correct number from the third column of Table 11.E.

If you type an unidentifiable model number, or give an illegal response to any of the DKINIT.SV questions, the program types out an appropriate error message and repeats the question.

DKINIT then types:

DISK UNIT?

which is a request for the name of your disc.

Table 11.E Disc Model Numbers

DGC Model Number	Disc Drive Type	Type In
6001-6008	Fixed-head NOVADISK (no cartridge), 0.13 megabyte (Mb) to 2 Mb.	6001 } to 6008 }
6063 or 6064	Fixed-head (no cartridge), for 1 Mb for 2 Mb.	6063 } 6064 }
4047A, 4047B 4237, 4238	Front-loading cartridge, 2.4 Mb.	4047 } 4237 } or 4238 }
6045 series	Top-loading cartridge with fixed disc, 10 Mb.	6045 }
4234A	Top-loading cartridge with fixed disc, 10 Mb.	4234 }
6070	Top-loading cartridge with fixed disc, 20 Mb.	6070 }
6099	Sealed moving-head disc, 12.5 Mb.	6099 }
4048A	Top-loading pack (6 platters), 6.2 Mb.	4048 }
4057A	Top-loading pack (11 platters), 25 Mb.	4057 }
4231A	Top-loading pack (11 platters), 92 Mb.	4231 }
6060	Top-loading pack (11 platters), 96 Mb.	6060 }
6061	Top-loading pack (11 platters), Double density, 109 Mb.	6061 }
6067	Top-loading pack (5 platters), 50 Mb.	6067 }
6122	Top-loading pack (11 platters), 277 Mb.	6122 }

10. Type in the correct name from the third column of Table 11.F; e.g., DP0}.

11. Then DKINIT requests a command, and you type:

COMMAND? FULL}

With this response you request a full initialization of the disc. DKINIT.SV will fully check out your disc, detect any portions that will not retain information and mark them so that RDOS will bypass them. It also constructs and saves on the disc certain tables that RDOS needs.

DKINIT.SV asks you several questions during this initialization. These are more fully explained in Chapter 11 of *How to Load and Generate Your RDOS System*, (093-000188-02). For the moment, key in only the answers in the dialog shown in the DKINIT.SV dialog following and take it on faith that the programs work.

The program takes some time to check out each pattern successively, so don't be alarmed when you have to wait. Typical time for a test pattern is up to 90 sec for a single front-loading disc, and up to 2-1/2 min for each 4234A disc. If you have a very large disc, like a 6061, the time *per pattern* can exceed a half-hour. While initializing a large disc, you may want to leave the computer and do something else. You can do so after the first pattern runs without error messages.

When you complete the following DKINIT.SV dialog, the disc is fully initialized and the computer halts.

Table 11.F RDOS Disc Names

DGC Model Number	Disc Drive Type	Type In
6001-6008	Fixed-head NOVADISK (no cartridge).	DK0}
6063/6064	Fixed-head (no cartridge), 1 or 2 Mb.	DS0}
4047A, 4047B 4237, 4238	Front-loading cartridge, 2.5 Mb.	DP0}
6045, 4234A, 6070	Top-loading cartridge 5 Mb or 10 Mb per disc.* Unit name of cartridge Unit name of fixed disc	DP0} DP0F}
6099	Sealed moving-head disc, 12.5 Mb.	DP0}
4048A	Top-loading pack (6 platters), 6.2 Mb.	DP0}
4057A	Top-loading pack (11 platters), 25 Mb.	DP0}
4231A	Top-loading pack (11 platters), 92 Mb.	DP0}
6060/6061, 6122	Top-loading pack (11 platters), 96, 190, or 277 Mb.	DZ0}
6067	Top-loading pack (5 platters), 50 Mb.	DZ0}

* Each disc on these top-loaders is logically distinct, and you will run DKINIT on each one.

DKINIT.SV Dialog

COMMAND? FULL }
COMMAND DESTROYS ANY PREVIOUS RDOS DISK STRUCTURE
RDOS INIT/F MUST BE DONE ON DISK AFTER COMMAND
TYPE CONTROL-A NOW TO ABORT WITHOUT LOSS

- a. *NUMBER OF PATTERNS TO RUN (1-5)? 5 }*
****PATTERN #1 (155555)****
****PATTERN #2 (133333)****
****PATTERN #3 (066667)****
****PATTERN #4 (155556)****
****PATTERN #5 (125252)****
****ALL PATTERNS RUN****
- b. *DO YOU WISH TO DECLARE ANY BLOCKS BAD*
THAT ARE NOT ALREADY IN THE BAD BLOCK TABLE? NO }
DEFAULT REMAP AREA SIZE IS xx BLOCK(S) LONG (make note of xx)
IT NEEDS TO BE AT LEAST n BLOCK(S) LONG (n is the number of bad
blocks DKINIT found)
- c. *REMAP AREA SIZE (TYPE RETURN FOR DEFAULT)? }*
- d. *REMAP AREA START BLOCK NUMBER (TYPE RETURN FOR*
DEFAULT)? }
DEFAULT FRAME SIZE IS dd
MIN IS 1, AND MAX IS mmm (dd and mmm vary with the disc.)
- e. *DISK FRAME SIZE (TYPE RETURN FOR DEFAULT)? }*
FULL DISK INIT COMPLETE
COMMAND?
- f. For a single disc platter or disc pack, you're done; type STOP } and skip the rest of the steps. If you are generating STUDENTSYS, type STOP } .
 For a dual-platter, top-loader subsystem (Model 6045,6070, or 4234) type
 DISK }
 DISK INITIALIZER REV x.xx
- g. *DISK DRIVE MODEL NUMBER? nnnn }* (original model number)
- h. *DISK UNIT? DP1F }* (DP0F } for 4234 discs)
- i. Repeat steps a. through e. to initialize the fixed disc. When DKINIT asks *COMMAND?*, type STOP } .

Installing the Bootstrap Root

Next, you want to put the disc bootstrap root on your disc(s). This root helps you start systems or program using only the program load switches. The program that installs the root is **BOOT.SV**. As you did with **DKINIT**, you must bring the **TBOOT.SV** — this time to load the installer portion of **BOOT.SV**.

12. Program load your computer.

- a. If it has a programmed console, type:

100022L

on the system console and proceed.

- b. If the computer has data switches and automatic program load, lift the **RESET** switch, then the **PROGRAM LOAD** switch; proceed.

- c. If the computer has data switches but lacks automatic program load, execute Step 6 and return here.

13. Once again, **TBOOT.SV** types:

FROM MT0:

Type 5, the file number that contains **BOOT.SV**:

5)

Your response loads the installer portion of **BOOT.SV** **BOOT** says:

BOOTSTRAP DEVICE SPECIFIER?

14. Respond with the same disc-identifying name (**DP0** , **DZ0** etc.) from Table 11.F that you gave to **DKINIT**.

BOOT now says:

INSTALL BOOTSTRAP (Y OR N)?

15. Type

Y)

and **BOOT** will say:

DONE.

BOOTSTRAP DEVICE SPECIFIER?

16. Skip this step if you are generating **STUDENTSYS**. If you have a dual-platter, top-loader disc, type **DP0F** , then **Y**, to install the bootstrap on the fixed disc. **BOOT** will then ask *SPECIFIER?* again.

Installing the RDOS Starter System

With the disc(s) initialized and the bootstrap root installed, you can now install the RDOS Starter System. Once again, you must bring TBOOT.SV in from file 0 of the tape to do this.

17. Program load your computer.
 - a. If it has a programmed console, press the BREAK key on your system console, then type:
100022L
and go on to the next step.
 - b. If your computer has data switches and automatic program load, lift the RESET switch, then the PROGRAM LOAD switch.
 - c. If it lacks auto program load, execute Step 6, then return here.
18. Once again, TBOOT.SV asks for file number:
FROM MT0:
Type 2, the file number that contains the starter system:
2)
19. You have directed TBOOT.SV to load the RDOS Starter System into the computer. When it is brought in, it requests:
FULL(F) OR PARTIAL (P OR <CR>)?
asking you to specify either full initialization or partial initialization for your disc. You want full initialization. This corresponds to the warning that DKINIT.SV gave you: *RDOS INIT/F MUST BE DONE ON DISK AFTER COMMAND.* Type:
F)
20. The program then asks:
INITIALIZING WHAT DISK?
Respond with the same disc-identifying name (DP0) ,DZ0) , etc.) from Table 11.F that you gave to DKINIT.
21. The program then loads additional portions of the RDOS Starter System from another file of the magnetic tape and stores them on the disc.
RDOS next asks for the current date. Type in the date (month, day, and year) as follows:
DATE (M/D/Y)? 1/10/79)
22. Next, it asks for the time. Type in the time (hours in 24, minutes, seconds), as follows:
TIME (H:M:S)? 14 10)

RDOS then reads file number 1 from the magnetic tape and saves its programs on disc. Included is the Command Line Interpreter program CLI, which lets you communicate with RDOS from the system console.

When RDOS types the prompt letter

R

your RDOS Starter System is running. It is also stored on the disc with the file-name BOOTSYS.SV. (Its overlay file is stored with the name BOOTSYS.OL.) Thus, you can henceforth bring your Starter System into execution directly from the disc via the computer front panel switches.

Transferring the Remaining Tape Files

You still need to transfer several tape files to your disc; the utility programs you received under your license, and the RDOS system generation program and libraries you need to generate your tailored system.

23. First, start recording in the log file.

LOG/H)

R

records all console dialog in file LOG.CM.

24. Now, identify the tape drive to RDOS:

INIT MT0)

R

25. Create a directory called SYSGEN and make it your current directory. Type:

C DIR SYSGEN)

R

D IR SYSGEN)

R

26. Load the SYSGEN programs and the relocatable loader. Type:

LOAD/V MT0:6 *SYSGEN.SV RLDR.<SV,OL>)

(The CLI verifies files loaded.)

R

27. Load the next tape file. Type:

LOAD/V MT0:7)

R

28. Make the master directory the current directory, and release the SYSGEN directory. Type:

```
DIR %MDIR% )  
R  
RELEASE SYSGEN )  
R
```

29. Create another subdirectory, UTIL, and make it the current directory.

```
CDIR UTIL )  
R  
DIR UTIL )  
R
```

30. Load the utilities into this directory.

```
LOAD/V MT0:6 )  
  
.  
  
.  
.  
R
```

31. Make the master directory the current directory, release the tape transport and the UTIL directory.

```
DIR %MDIR% )  
R  
RELEASE MT0 )  
R  
RELEASE UTIL )  
R
```

32. Skip this step if you are generating STUDENTSYS. Now, if you have a dual-platter top loader disc, make the fixed disc available to RDOS and give it a copy of BOOT.SV by typing:

```
INIT/F DP0F )  
R  
MOVE/V DP0F BOOT.SV )  
BOOT.SV  
R
```

33. Now close the log file:

```
ENDLOG )  
R
```

If you have a teletypewriter as your system console, the typed list of filenames is your record of programs loaded. (If your system console is a display terminal, you must generate a tailored system before you can PRINT the log file on the line printer.)

Your RDOS Starter System is now complete.

34. If you want to rest for a while, type:

RELEASE DP0) (or DZ0) , etc.)

This terminates RDOS operations. RDOS displays a sign-off message:

MASTER DEVICE RELEASED

You can now flip the disc's LOAD/RUN switch to LOAD, and remove the disc pack or cartridge (if this applies).

You're done with the magnetic tape, so use the tape drive switches to RESET and UNLOAD the tape. Store it safely without inserting a plastic write-enable ring. You can now turn the drive OFF, and power down your other equipment.

Loading the RDOS Starter System from Diskettes

There are several different types of diskette/disc combinations. In one combination, the diskette and disc have separate controllers, which give them different device codes. In another combination, the diskette and disc share a controller, which gives them the same device code; this adds a few steps to the procedure of loading the RDOS Starter System. (The device code is essential, because it is the number you will use to program load the computer from diskette or disc.)

Generally, assume that your diskette is on its primary controller device code 33g. (But regardless of your disc/diskette combination and device code(s), you will be shown how to discover them and load the RDOS Starter System using them.)

The RDOS Diskettes

When you receive your RDOS system on diskettes, Data General supplies RDOS software on one to four diskettes. If you have a double-density diskette drive, this software fits on one or two diskettes, depending on your type of computer. If you have a single-density diskette drive, the RDOS software fits on three or four diskettes, depending on your type of computer.

Double-density diskettes have two read/write surfaces, thus they hold four times as much as single-density diskettes. A drive that runs one type of diskette cannot run the other.

In this section, you will use every RDOS diskette (one to four) that Data General supplies. Table 11.G describes the programs included on single-density diskettes; Table 11.H describes the programs included on double-density diskettes.

Preliminary Steps

This section assumes that you have already performed the following preliminary steps:

- a. Your equipment is powered up.
- b. You've loaded a disc into disc drive unit 0 and the drive is ready.
- c. All your consoles are online and in ALPHA LOCK. (Actually, you will only be using the system console. To discover which console is the system console power them all up, and find the one that displays the messages described in the following steps.)

Table 11.G The RDOS Single-Density Diskettes

Diskette Number	Program Names	File Contents
1	BOOT.SV	A program that can install a bootstrap root on the disc and, using this program, can execute other programs in the computer.
	DKINIT.SV	A disc initializer program that you must run on a hard disc before you can put any programs on it
	FDBOOT.SV	A program that copies the starter system, FDBOOTSYS.SV, from file 0 on this diskette to your hard disc. FDBOOT then invokes the starter system.
	0	This file contains the starter system. FDBOOT reads and copies it to the hard disc.
	1	Contains system library files that you LOAD onto your hard disc.
2	2	Contains utility programs (text editors, assemblers, etc.) that you LOAD onto your hard disc.
3	3	Contains other utility programs and the system generation libraries.
4	4	Contains certain hardware support programs. Depending on your hardware, you may not get this file or diskette.

Table 11.H The RDOS Double-Density Diskettes

Diskette Number	Program Names	File Contents
1	BOOT.SV	A program that can install a bootstrap root on the disc and, using this program, can execute other programs in the computer.
	DKINIT.SV	A disc initializer program that you must run on a hard disc before you can put any programs on it.
	FDBOOT.SV	A program that copies the starter system, FDBOOTSYS.SV, from file 0 on this diskette to your hard disc. FDBOOT then invokes the starter system.
	0	This file contains the starter system. FDBOOT reads and copies it to the hard disc.
	1	This file contains system library files and utility programs (text editors, assemblers, etc.) that you LOAD onto your hard disc.
2	1	ZRDOS only. This file contains system library files for ZRDOS systems.

Program Load

To read programs in from diskette, you must insert the appropriate diskette in diskette drive 0 and program load your computer. (For the rest of this section, the word "diskette" means a system diskette that you received from Data General and "disc" means the hard disc that will hold your tailored system.)

1. If your disc drive and diskette drive are on different controllers, make sure both drives have unit number 0 selected (if the drives have unit selector). (Only Model 6098/6099, 6045, or 4234 discs can share a controller with a diskette; if you don't have one of these, your disc and diskette are on different controllers. If the diskette has its own controller, generally this is the second controller; the diskette name is DP4 and its device code is 100073 octal. These will remain constant in the future. If the diskette has its own controller, skip to Step 3.)
2. If your disc drive *does* share a controller with the diskette drive, you must make the diskette drive number 0 and the disc drive number 1.
 - a. If *both* disc and diskette have thumbwheel drive number selectors, then you have a Model 6045 disc. Dial "0" on the diskette selector and "1" on the disc selector; go to Step 3.
 - b. If *neither* disc or diskette drive has a selector, then you have a Model 6098/6099 sealed disc/diskette subsystem. On this, you must use a switch to make the diskette drive number 0.

Pull down the two clips at the side of the disc front panel and remove the panel. At the bottom of the disc drive, you'll see a 2-in. cutout in the sheet metal, with arrows and type next to it. Examine this cutout and you'll see two small toggle switches. Ignore the left switch (WRITE PROTECT), and move the right switch (DRIVE 0 SELECT) to the left; i.e., to the position marked DSK1/FPY0. This makes the diskette drive 0 (name DP0) and the disc drive 1 (name DP1). The diskette will remain DP0 and the disc DP1 throughout this section.

Leave the disc panel off temporarily and proceed to Step 3.

- c. If the diskette drive has a selector and the disc drive does not, then you have a Model 4234 dual-platter disc subsystem. On a Model 4234 disc, there is no select switch and the disc is always named DP0/DP0F when it is READY; this will require you to execute several extra steps, as noted, in this section. To make the diskette drive 0 (required for program load), flip the disc's LOAD/RUN switch to LOAD and dial 0 on the diskette selector.
3. Remove the appropriate Data General-supplied diskette from its envelope. This is diskette 1 if you received three or four RDOS diskettes for a single-density diskette drive; it is the *only* RDOS diskette you received if you have a double-density diskette drive. Do *not* cover the write-protect hole on this diskette.

Make sure power is on to the diskette drive. Open the door to the diskette drive by pressing the latch button (double-density diskettes) or by depressing the latch tab (single-density diskettes). Slide the DG diskette, with its label up and heading toward you, firmly into its slot. When it stops sliding, release it and close the diskette door.

4. If your computer has a programmed console, go to Step 5. If it has hardware data switches and automatic program load, go to Step 6. If it has data switches and lacks automatic program load, go to Step 7.
5. The display terminal or printing system console should show a number and an exclamation point (!) prompt. (If not, flip the computer power switch OFF and ON.) Find nn in Table 11.I and type:
1000nnL (often, 100033L)
on the system console. Go to Step 8.
6. For the computer with data switches and automatic program load, set the data switches as shown in Table 11.I. Lift the RESET switch, then the PROGRAM LOAD switch. Go to Step 8. (On a SUPERNOVA, set the switches to 00033g and press CHANNEL START.)

Table 11.I Diskette Device Codes

Disc/Diskette	n =	With hardware data switches, set these switches up, others down:
Disc and diskette on 1 primary controller (Models 6045, or 4234).	33	0, 11, 12, 14, 15
Disc and diskette each with primary controller.	33	0, 11, 12, 14, 15
Diskette on secondary controller.	73	0, 10, 11, 12, 14, 15

7. Without automatic program load, you'll key a two-word program into the switches. Follow these steps (they are listed here, then you are referred to this section later).
 - a. Set the data switches to 000376g.
 - b. Lift the EXAMINE switch, and, on a NOVA 3 computer, hold it up. Verify that the lamps lit match the switches in the up position.
 - c. Find nn in Table 11.I and set the data switches to 0601nng.
 - d. Lift the DEPOSIT switch, and, on a NOVA 3, hold it up. Verify that the lamps lit match the switches set in the up position.
 - e. Set the data switches to 000377g.

- f. Depress the DEPOSIT NEXT switch and, on a NOVA 3, hold it down. Verify that the lamps lit match the switch settings.
 - g. Set the data switches to 000376g. Lift and release the RESET switch, then the START switch. You are now executing a two-word program that you just loaded into the computer's memory.
8. By either automatic program load hardware or your manual two-word program, the computer now reads program BOOT.SV in from the diskette and executes it. (If nothing happens, open and close the diskette door to reset the read/write head and try Step 4 again. If this doesn't work, try Step 4 again, but use the device code for the other controller.)

The bootstrap program asks the question:

FILENAME?

The Disc Initializer

BOOT.SV has typed out:

FILENAME?

9. Type in your response:

DKINIT)

Pressing the ↵ (RETURN) key tells the computer to accept the value preceding the ↵. If you make a mistake while typing in an answer but before pressing ↵, press the DEL or RUBOUT key to erase the bad characters one by one.

DKINIT echoes an underscore (_) for each character erased. If DKINIT stops responding altogether after an answer, turn the computer OFF and ON, open and close the diskette door, and start again at Step 4.

You have asked BOOT to read and execute DKINIT.SV, the disc initializer program. DKINIT types out:

DISK INITIALIZER REV x.xx (xx = revision number)
DISK DRIVE MODEL NUMBER?

10. Skip this step unless you have a Model 4234 disc. With a 4234 disc, dial 1 on the diskette drive selector; then flip the disc LOAD/RUN switch to RUN and wait for the READY light.

11. DKINIT is asking for the Data General model number of your hard disc. Type in the correct number from column 3 of Table 11.J (e.g., 6099 } , 6070 } , etc.)

Table 11.J Disc Model Numbers

DGC Model Number	Disc Drive Type	Type In
6001-6008	Fixed-head NOVADISK (no cartridge), 0.13 megabyte (Mb) to 2 Mb.	6001 } to 6008 }
6063	Fixed-head (no cartridge), 1 Mb.	6063 }
6064	Fixed-head (no cartridge), 2 Mb.	6064 }
4047A, 4047B 4237, 4238	Front-loading cartridge, 2.4 Mb.	4047 } 4237 } or 4238 }
6045	Dual-platter disc with top-loading cartridge, 10 Mb (5 Mb each disc).	6045 }
6070	Dual-platter disc with top-loading cartridge, double-density, 20 Mb (10 Mb each disc).	6070 }
6099	Sealed moving-head disc, 12.5 Mb.	6099 }
4234	Dual-platter disc with top-loading cartridge, 10 Mb (5 Mb each disc).	4234 }
4048A	Top-loading pack, 6 platters, 6.2 Mb.	4048 }
4057A	Top-loading pack, 11 platters, 25 Mb.	4057 }
4231A	Top-loading pack, 11 platters, 92 Mb.	4231 }
6060	Top-loading pack, 11 platters, 96 Mb.	6060 }
6061	Top-loading pack, 11 platters double-density, 190 Mb.	6061 }
6067	Top-loading pack, 5 platters, 50 Mb.	6067 }
6122	Top-loading pack, 11 platters, 277 Mb.	6122 }

If you type in an unidentifiable model number, or give an illegal response to any DKINIT question, the program will type out an appropriate error message and repeat the question.

DKINIT now asks:

DISK UNIT?

which is a request for the name that identifies your hard disc.

- Find your disc unit name in column 3 of Table 11.K and circle it. You'll be typing in this disc name (or names) twice more in this section. Type in the name (e.g., DP0 } or DP1 }).

Table 11.K Disc Unit Names

DGC Model Number	Disc Drive Type	Type In
6001-6008	Fixed-head NOVADISK (no cartridge), 0.13 megabyte (Mb) to 2 Mb.	DK0}
6063 or 6064	Fixed-head (no cartridge), 1 Mb or 2 Mb.	DS0}
4047A, 4047B 4237, 4238	Front-loading cartridge, 2.4 Mb.	DP0}
6070	Dual-platter disc with top-loading cartridge, double-density, 20 Mb.* Unit name of removable cartridge Unit name of fixed disc	DP0} DP0F}
6045	Dual-platter disc with top-loading cartridge and drive selector, 10 Mb, shares controller with single-density diskette.* Unit name of removable cartridge Unit name of fixed disc	DP1} DP1F}
6099	Sealed moving-head disc, shares controller with double-density diskette.	DP1}
4234	Dual-platter disc with top-loading cartridge, no drive selector, 10 Mb, shares controller with single-density diskette.* Unit name of removable cartridge Unit name of fixed disc	DP0} DP0F}
4048A, 4057A, or 4231A	Top-loading pack, 6 or 11 platters, 6.2 to 92 Mb.	DP0}
6060, 6061 6067 or 6122	Top-loading pack, 5 or 11 platters, 50 to 277 Mb.	DZ0}

*The discs on these top-loaders are logically distinct and you will run DKINIT on each.

13. Now, if your entries were correct, DKINIT requests a command:

COMMAND?

Type:

FULL ↵

With this, you request a full initialization of the disc. DKINIT.SV will fully check out your disc, detect portions that will not retain information, and mark them so that RDOS will bypass them. It will also construct on the disc certain tables that RDOS needs.

DKINIT.SV asks you several questions during this initialization; these are more fully explained in Chapter 11 of *How to Load and Generate Your RDOS System*, (093-000188-02). For the moment, just key in the answers shown in the DKINIT.SV dialog and take it on faith that the program works. Ignore the Control-A instruction.

DKINIT takes some time to check out each pattern, so don't be alarmed when you have to wait. Typical time for a test pattern is up to 90 sec for a single front-loading disc, and up to 2-1/2 min for a 6045 or 4234A disc. If you have a very large disc, like a 6061, the time can exceed a half-hour per pattern. While initializing a large disc, you may want to leave the computer and do something else. You can do so after the first pattern runs without error messages.

After you complete the DKINIT.SV dialog, the disc is fully initialized and the computer halts.

Installing the Bootstrap Root

Next, you'll install the disc bootstrap root on your disc(s). This root will help you start systems or programs using only the program load steps. The program that installs the root is BOOT.SV. As you did with DKINIT, you must go through the program load steps — this time to load the installer portion of BOOT.SV.

14. Open and close the diskette door. This ensures that the diskette read/write head is at the beginning of the diskette.
15. Skip this step unless you have a Model 4234 disc. With a Model 4234 disc, flip the disc LOAD/RUN switch to LOAD; then dial "0" on the diskette drive.

16. Program load your computer. If it has a programmed console type:
 1000nnL (usually 100033L or see Table 11.I)
 on the system console and proceed.
 If the computer has data switches and automatic program load, lift the RESET switch, then the PROGRAM LOAD switch; proceed.
 If the computer has data switches but lacks auto program load, execute Step 7 and return here.
17. Once again, BOOT.SV types:
FILENAME?
 (If nothing happens, execute Steps 14 and 16 again.)
18. Type:
 BOOT ↓
 This reads in the installer portion of BOOT.SV. BOOT says:
BOOT x.xx
BOOTSTRAP DEVICE SPECIFIER?
19. Skip this step unless you have a Model 4234 disc. With a 4234 disc, dial 1 on the diskette drive; then flip the disc LOAD/RUN switch to RUN and wait for the READY light.
20. Respond with the same disc-identifying name (DP0↓ , DP1↓ , DZ0↓ , etc.) from Table 11.K that you gave the DKINIT.
 BOOT now says:
INSTALL BOOTSTRAP (Y OR N)?
21. Type:
 Y↓
 and BOOT will say:
DONE
BOOTSTRAP DEVICE SPECIFIER?
22. Skip this step if you are generating STUDENTSYS. If you have a dual-platter top-loader disc, type DP1F↓ , then Y, to install the bootstrap root on the fixed disc. (Or, for a Model 4234 disc, type DPOF↓ and Y.) BOOT will then ask SPECIFIER? again.

DKINIT.SV Dialog

COMMAND? FULL)
COMMAND DESTROYS ANY PREVIOUS RDOS DISK STRUCTURE
RDOS INIT/F MUST BE DONE ON DISK AFTER COMMAND
TYPE CONTROL-A NOW TO ABORT WITHOUT LOSS

- a. NUMBER OF PATTERNS TO RUN (1-5)? 5)
PATTERN #1 (155555)
PATTERN #2 (133333)
PATTERN #3 (066667)
PATTERN #4 (155556)
PATTERN #5 (125252)
ALL PATTERNS RUN
- b. DO YOU WISH TO DECLARE ANY BLOCKS BAD
THAT ARE NOT ALREADY IN THE BAD BLOCK TABLE? NO)
DEFAULT REMAP AREA SIZE IS xx BLOCK(S) LONG (make note of xx)
IT NEEDS TO BE AT LEAST n BLOCK(S) LONG (n is the number of bad
blocks DKINIT found)
- c. REMAP AREA SIZE (TYPE RETURN FOR DEFAULT)?)
- d. REMAP AREA START BLOCK NUMBER (TYPE RETURN FOR
DEFAULT)?)
DEFAULT FRAME SIZE IS dd
MIN IS 1, AND MAX IS mmm (dd and mmm vary with the disc.)
- e. DISK FRAME SIZE (TYPE RETURN FOR DEFAULT)?)
FULL DISK INIT COMPLETE
COMMAND?
- f. For a single disc platter or disc pack, you're done; type STOP) and skip the
rest of the steps. If you are generating STUDENTSYS, type STOP) and skip
the rest of the steps. For a dual-platter top-loader subsystem (Model 6045, 6070,
or 4234) type:
DISK)
DISK INITIALIZER REV x.xx
- g. DISK DRIVE MODEL NUMBER? nnnn) (original model number)
- h. DISK UNIT? DP1F) (DP0F) for 4234 discs)
- i. Repeat Steps a. through e. to initialize the fixed disc. When DKINIT asks
COMMAND?, type STOP) .

Installing the RDOS Starter System

With the disc(s) checked out and the bootstrap root installed, you can now install the RDOS Starter System.

23. BOOT is still asking for SPECIFIER? Get your diskette name from Table 11.L and force BOOT to ask FILENAME by typing the diskette name and N:

name | (usually, DP0 |)

INSTALL BOOTSTRAP (Y OR N)?

24. Type:

N |

FILENAME?

25. Answer BOOT's *FILENAME?* query by typing:

SYS |

BOOT now uses link SYS to load FDBOOT, which in turn loads the starter system and executes it. This may take 3 or 4 min. (If you get a *FILE DOES NOT EXIST* message from SYS | try Steps 23 and 24 again.)

Eventually, the starter system will come up and type out:

NOVA RDOS REV x.x (x.x is the revision number)

DISK ID?

26. Type in the same hard-disc name (DP0 | , DP1 | , DZ0 | , etc.) from Table 11.K that you gave to DKINIT.

The starter system then asks:

FULL INIT (Y/N)?

Table 11.L Diskette Names before System Generation

If you program loaded from code:	The diskette "name" is:
100033 on all but 4234 systems	DP0
100033 on 4234 systems	DP1
100073 on all but 4234 systems	DP4
100073 on 4234 systems	DP5

27. It's asking whether or not you want an RDOS full initialization on the hard disc. You want a full initialization from RDOS; this corresponds to the warning DKINIT gave you: *RDOS INIT/F MUST BE DONE ON DISK AFTER COMMAND*. Type:

Y |

The starter system now does an INIT/F and copies itself from the diskette to the disc. It then executes itself from the disc. This takes 2 or 3 min. You will see the messages:

MASTER DEVICE RELEASED

NOVA RDOS REV x.x

DATE (M/D/Y)?

The diskette has been released and the starter system is now running from the hard disc.

28. Enter the current date in the format (month day year); either a space or slash can separate your entries. For example:

1 10 79)

TIME (H:M:S)?

29. Enter the time in the format "hours minutes seconds." Hours should be in 24-hr form; either a space or colon can separate your entries. The seconds entry is optional; for example:

14 10)

Now the starter system invokes the Command Line Interpreter (CLI). The CLI allows you to communicate with RDOS from the console. The CLI prompt is:

R

With the CLI running, you can load the rest of the files from the system diskette(s). The original diskette 1 is still in DP1; it contains more files to be loaded.

30. Start recording the log file by typing:

LOG/H)

This records all CLI dialog (including filenames loaded) in disc file LOG.CM.

31. Next, initialize the diskette so that you can load files from it. The diskette-name is the name shown in Table 11.L. It is usually DP0, but with a 4234 disc it is DP1. Type:

INIT diskette-name) (usually INIT DP0)

R

32. Now, create a directory called UTIL and make it your current directory. (Load utility programs into this directory.) Type:

CDIR UTIL)

R

DIR UTIL)

R

33. If you received one or two RDOS diskettes, you have a double-density drive; go to Step 40. If you received three or four diskettes go to Step 34.

Loading the Remaining Files from Single-Density Diskette

34. Load the first file from diskette 1. Here, *diskette-name* is the name shown in Table 11.L. It is usually DP0, but with a 4234 disc it is DP1. Type:

```
LOAD/V diskette-name:1)      (usually DP0:1)
```

(The CLI displays filenames as it loads onto hard disc. Wait for the R prompt.)

R

35. Now, get back to the master directory, release the UTIL directory, create another directory SYSGEN, and make it the current directory. Type:

```
DIR %MDIR%)
```

R

```
RELEASE UTIL)
```

R

```
CDIR SYSGEN)
```

R

```
DIR SYSGEN)
```

R

36. In this step you will load all the files necessary for system generation into the current directory SYSGEN. These files are:

1. ALMSPD.SR
2. ALMSPD.RB
3. RLDR.SV
4. RLDR.OL
5. *SYSGEN.SV (where * is the RDOS flavor)
6. Several system generation library files.

These files may be located on any of the remaining diskettes. To find them all, you need to execute the following command three times, once for each of the remaining diskettes:

```
LOAD/V diskette-name:x ALMSPD.<SR,RB> RLDR.<SV,OL> -.LB†)
*SYSGEN.SV
```

(*diskette-name* is the name shown in Table 11.L. It is usually DP0, but with a 4234 disc it is DP1. *x* is 2, 3 and 4.)

Since these files are distributed over the three diskettes, you may see some error messages. For example:

```
FILE NOT FOUND: ALMSPD.SR
```

As long as you type the command exactly as shown, these errors are of no consequence. Do Steps a, b, and c.

- a. Remove diskette 1 from the drive; don't RELEASE it first.

Insert diskette 2 into the drive and type:

```
LOAD/V DP0:2 ALMSPD.<SR,RB> RLDR.<SV,OL> -.LB *SYSGEN.SV)
```

(or DP1:2 with a 4234 disc)

R

- b. After receiving the R prompt, remove diskette 2 from the drive and insert diskette 3. Don't RELEASE the drive. Type:

```
LOAD/V DP0:3 ALMSPD.<SR,RB> RLDR.<SV,OL> -.LB *SYSGEN.SV)
```

(or DP1:3 with a 4234 disc)

R

- c. After receiving the R prompt, remove diskette 3 from the drive and insert diskette 4. Don't RELEASE the drive. Type:

```
LOAD/V DP0:4 ALMSPD.<SR,RB> RLDR.<SV,OL> -.LB *SYSGEN.SV)
```

(or DP1:4 with a 4234 disc)

R

37. You've just loaded all the system generation files. Next load the utilities. First, make the master directory the current directory, release the SYSGEN directory, and make UTIL the current directory. Type:

```
DIR %MDIR%)
```

R

```
RELEASE SYSGEN)
```

R

```
DIR UTIL)
```

R

38. Now you're ready to load the utility programs, which are also dispersed over three diskettes. To avoid some duplication, you need to execute the following command three times, once for each remaining diskette:

```
LOAD/V diskette-name:x ALMSPD.<SR,RB> /N -.LB/N *SYSGEN.SV/N)
```

(diskette-name is the name shown in Table 11.L. It is usually DP0, but with a 4234 disc it is DP1. x is 2, 3 and 4. Again some errors may be reported. Do Steps a, b and c.)

- a. Diskette 4 is now in the drive. Type:

```
LOAD/V DP0:4 ALMSPD.<SR,RB> /N - .LB/N *SYSGEN.SV/N}
```

(or DP1:2 with a 4234 disc)

R

- b. After receiving the R prompt, remove diskette 4 from the drive and insert diskette 3. Don't RELEASE the drive. Type:

```
LOAD/V DP0:3 ALMSPD.<SR,RB> /N - .LB/N *SYSGEN.SV/N}
```

(or DP1:3 with a 4234 disc)

R

- c. After receiving the R prompt, remove diskette 3 from the drive and insert diskette 2. Don't RELEASE the drive. Type:

```
LOAD/V DP0:2 ALMSPD.<SR,RB> /N - .LB/N *SYSGEN.SV/N}
```

(or DP1:4 with a 4234 disc)

R

39. Now release the UTIL directory and go to Step 45.

```
DIR %MDIR%}
```

R

```
RELEASE UTIL}
```

R

Loading the Remaining Files from Double-Density Diskette

40. Your current directory is UTIL and now you are ready to load the utility programs. Type:

```
LOAD/V DP0:1 ALMSPD.<SR,RB> /N - .LB/N *SYSGEN.SV/N }
```

(CLI verifies files as it loads them)

R

41. Now, get back to the master directory, release the UTIL directory, create another directory SYSGEN, and make it the current directory. Type:

```
DIR %MDIR%}
```

R

```
RELEASE UTIL}
```

R

```
CDIR SYSGEN }
```

R

```
DIR SYSGEN }
```

R

42. In this step, load all the system generation files. Type:

```
LOAD/V DP0:1 ALMSPD.<SR,RB> RLDR.<SV,OL> - .LB *SYSGEN.SV
```

(or DP4:1, see Table 11.L)

43. Perform this step only if you are using a Mapped ECLIPSE other than an S200 or C300 (i.e., perform this step if you're using ZRDOS). Load the ZRDOS file from the second diskette. Type:

```
DIR %MDIR%
```

R

```
RELEASE DP0 (or DP4:1, see Table 11.L)
```

R

Now remove diskette 1 from the diskette drive and insert diskette 2 in diskette drive 0.

```
INIT DP0 (or DP4:1, see Table 11.L)
```

R

```
DIR SYSGEN
```

R

```
LOAD/V DP0:1
```

(CLI verifies files as it loads them.)

R

44. Now get back to the master directory and release SYSGEN.

```
DIR %MDIR%
```

R

```
RELEASE SYSGEN
```

R

The Final Steps

45. Now, if you have a dual-platter top-loader disc, make the fixed disc available to RDOS and give it a copy of `BOOT.SV` by typing:

```
INIT/F DP1F (DP0F for a 4234 disc)
```

R

```
MOVE/V DP1F BOOT.SV (DP0F for a 4234 disc)
```

```
BOOT.SV
```

R

46. To close the log file, type:

ENDLOG)

R

If your system console is a keyboard/printer, the typed filenames are your record of the files loaded. If your console is a display terminal, you must generate a tailored system before you can print the log file on the line printer.

47. You've finished loading the starter system files and are nearly done with the starter system procedure. Release the hard disc by typing:

RELEASE %MDIR%)

RDOS will then sign off by typing:

MASTER DEVICE RELEASED

48. If the disc and diskette share a controller, make the disc into drive 0 and the diskette drive 1 (except for a 4234 disc, which is already drive 0).
- If both disc and diskette drive have a drive selector, dial 0 on the disc and 1 on the diskette.
 - If neither disc or diskette has a drive selector, turn to the disc front panel. Move the right-hand toggle switch marked DRIVE 0 SELECT, to the right; i.e., to the DSK0/FPY1 position. Replace the front-panel cover on the disc drive.

You've finished the starter system procedure. For the first controller, the diskette name is now DP1 and will remain DP1 unless you change it, either with the toggle switch or diskette thumbwheel. For the second controller (code 73), the diskette name is DP5.

The "disc" name is DP0, or, if the disc and diskette are on separate controllers, the name you gave DKINIT; e.g., DS0 or DZ0. (For a DP type of disc on the second controller, the disc name is DP4.)

Remove the diskette from its drive and replace it in its outer envelope. You're done with DG-supplied RDOS diskettes and can store them in a safe place.

Building a Tailored RDOS System

Disc Bootstrap

If you don't have a system running, you must bootstrap one into execution. For your first system, you'll bootstrap the RDOS Starter System. In fact, the following bootstrap instructions apply to any RDOS system on the disc, and you'll be using them whenever you bring up RDOS.

1. Power up all equipment if it is not already ON. Put the system console and line printer (if any) ON LINE. Stop the computer, either by pressing the keyboard BREAK key (programmed consoles) or the front-panel STOP switch (hardware data switches).
2. Insert the disc pack or cartridge into drive 0 (if applicable). Flip the LOAD/RUN switch to RUN and wait for the READY light.
3. Program load your computer from disc:
 - a. If you have a programmed console, type 1000nnL on the system console. See the second column of Table 11.M for nn.
 - b. If you have hardware data switches and automatic program load hardware, set the data switches to 1000nn; see Table 11.M for nn. Lift RESET, then PROGRAM LOAD. Go to Step 4.
 - c. If you do not have automatic program load hardware:
 - Set the data switches to 000376g (switches 8 through 14 up, others down); then lift EXAMINE.
 - Set the data switches to 0601nn. (See Table 11.M for nn.) Lift DEPOSIT.
 - Set the data switches to 000377g (switches 8 through 15 up, others down). Then depress DEPOSIT NEXT.
 - Set the data switches to 000376g (put down switch 15) and lift RESET, then START.

Table 11.M Disc Controller Device Codes

Disc Type	nn = (octal)	With hardware data switches, set these switches up (others down).
Fixed-Head Model 6063-6064		
Controller 1	26	0, 11, 13, 14
Controller 2	66	0, 10, 11, 13, 14
Model 6001-6008		
Controller 1	20	0, 11
Controller 2	60	0, 10, 11
Moving-Head Model 6060-6061, 6067/6122		
Controller 1	27	0, 11, 13, 14, 15
Controller 2	67	0, 10, 11, 13, 14, 15
Other Discs		
Controller 1	33	0, 11, 12, 14, 15
Controller 2	73	0, 10, 11, 12, 14, 15

4. Step 3 brings BOOT.SV off disc and into execution. It then asks:

FILENAME?

If you have an upper/lowercase console, hold down the SHIFT key, then type the name of the system or program you want to execute. For your first system, this is:

BOOTSYS! (or FBOOTSYS! for diskette)

Program BOOT.SV reads the system you specify into the computer, then relinquishes control to RDOS.

5. RDOS requests the current data (month, day, and year) and time (hours in 24, minutes, and seconds). Provide these in the format of the following example:

NOVA RDOS REV xx (xx = revision number)

DATE (M/D/Y)? 1 10 79!

TIME (H:M:S)? 16 53!

R

6. The R prompt indicates that the RDOS CLI is in control and ready to accept commands. The first command you enter makes the subdirectory SYSGEN the current directory. This is where you will generate your tailored system. Type:

DIR SYSGEN!

R

Multiplexors

SYSGEN asks questions about QTY, ALM, and ULM multiplexors. If you specify one of these, it then asks questions about line speed and interrupt characters. For your first system, you can default these. Later, if you decide on special characteristics for your multiplexed lines, read the section on multiplexors in Chapter 2 of the *RDOS Reference Manual* or the release notice supplied with your software.

If you want the new RDOS system to support Business BASIC, do not specify a multiplexor to SYSGEN. Business BASIC has its own multiplexor driver. For Extended BASIC, *do* specify a multiplexor to SYSGEN, if you want the new system to support a multiplexor.

System Generation

The R prompt indicates the RDOS Command Line Interpreter will now accept a command. Your command, of course, is to generate a new RDOS system. The system-generation command is:

ISYSGEN* For an INFOS-RDOS system;
 BSYSGEN For an ECLIPSE system without INFOS;
 NSYSGEN For a mapped NOVA 3 or NOVA 4 system;
 or
 SYSGEN For all other NOVA systems,

$\left. \begin{array}{l} \text{ISYSGEN} \\ \text{BSYSGEN} \\ \text{NSYSGEN} \\ \text{SYSGEN} \end{array} \right\} \text{SYS.}\langle \text{SV/S SG/V LM/L} \rangle !$

*INFOS system generation is beyond the scope of this course. The ISYSGEN command is shown here only for the sake of completeness. If you have an RDOS-INFOS system, follow the directions in the Data General publication *How to Load and Generate Your RDOS System*, (093-000188-02) and the release notice supplied with the software.

The RDOS system you generate will be stored in the disc file SYS.SV (rather than BOOTSYS.SV or FBOOTSYS.SV, which is the RDOS Starter System name). Its overlays will be stored in SYS.OL, the SYSGEN load map in SYS.LM and the SYSGEN dialog (see below) in SYS.SG.

In place of SYS as your system filename, you can type any other unique and previously unused filename, perhaps one that identifies your tailored system. For example:

$\left. \begin{array}{l} \text{ISYSGEN} \\ \text{BSYSGEN} \\ \text{NSYSGEN} \\ \text{SYSGEN} \end{array} \right\} \text{NICKSSYS.}\langle \text{SV/S SG/V LM/L} \rangle !$

However, SYS is conveniently the default name for disc bootstrapping. Do not generate a system with the same name as an existing system or program; this will delete the existing system or program and replace it with the new system.

All of your answers to SYSGEN are numeric and in decimal. If you default any answer by typing only RETURN (), SYSGEN accepts this as a "0" answer. Although bullets (•) identify the questions that follow in this section, no bullets appear on the system console.

SYSGEN first says:

type SYSGEN REV xx.xx
VALID ANSWERS ARE IN PARENTHESES
RESPOND ACCORDINGLY

- **MAPPED SYSTEM? ("0" = NO "1" = YES)**

Answer 1) if you wish to generate a mapped system. If you answer 0) SYSGEN skips to the "CORE STORAGE" question. For a mapped NOVA system, SYSGEN skips to the "NUMBER OF CHANNELS BACKGROUND" question.

INFOS SYSGEN asks the next question; ECLIPSE SYSGEN skips it:

- **PROCESSOR TYPE? ("1" = C/300 "2" = C/330 "3" = C/350)**

Answer with the type of ECLIPSE computer you have. If you answer 3) , SYSGEN skips to the "BURST MULTIPLEXOR" question.

ECLIPSE SYSGEN wants to know about your computer type:

- **S/250 OR C/350 TYPE PROCESSOR? ("0" = NO "1" = YES)**

Answer 1) to generate a system for an S/250 or C/350; SYSGEN then asks the next two questions. Answer 0) to generate a system for C/150, S/200 or S/230, or C/300 or C/330. If you answer 0) , SYSGEN skips the next two questions.

- **BURST MULTIPLEXOR CHANNEL (BMC) ("0" = NO "1" = YES)**

A burst multiplexor is a device for handling disc data; up to four Model 6060/6061-6067 or 6063/6064 discs can be attached to it. It is available as an option with certain mapped ECLIPSE machines. Answer 1) if you have one or more Model 6060 series or 6063 series discs attached to a burst multiplexor; otherwise answer 0) . If you answer 1) , SYSGEN will later ask you about discs wired to the BMC.

- **ARRAY PROCESSOR? ("0" = NO "1" = YES)**

If your main ECLIPSE computer is attached to an Array Processor, answer 1) . A 1) answer reserves 4K of the ECLIPSE memory for the AP, and allows remapping of data between the main processor and the AP. If you do not have an AP, or if a Satellite Processor and not the main computer is attached to the AP, answer 0) . In either case, SYSGEN skips the next question.

- **S/200 OR C/300 MAP? ("0" = NO "1" = YES)**

Answer 1) to generate a system for an ECLIPSE S/200 or C/300 processor. Answer 0) for a C/150, S/130, S/230, or C/330. If you answer 0) , SYSGEN goes *back* to the previous question, "ARRAY PROCESSOR?"

- ***MAXIMUM NUMBER OF CHANNELS BACKGROUND WILL USE (1-255)***

Answer with the maximum number of hardware I/O channels you will need to execute your background-mode programs. Each channel is a gateway to an input or output device or file. If any of your programs explicitly address channels by number, type the highest number addressed (in decimal), even if this exceeds the number of channels used. RDOS will not run a program that requests more channels (or a channel with a higher channel number) than the number you have selected with your answer to this question.

The Command Line Interpreter requires 14 channels, thus *the new system will not run if you answer less than 14* . If you will be running Extended BASIC, you typically will need five channels plus a number of channels equal to the maximum number of files that can be open at one time by all BASIC users. The COBOL compiler, if you have it, requires a minimum of 25 channels; the RPG compiler requires 27 channels.

If you're not sure how many channels you will need, and you're not running COBOL or RPG, then try 16 . This will accommodate most software. Then you can use the tuning option explained later to devise a more precise number after you have been running your RDOS system for awhile.

- ***MAXIMUM NUMBER OF CHANNELS FOREGROUND WILL USE (0-255)***

See the previous question to determine the number of channels you need. Extended BASIC, COBOL, and RPG require the same number of channels in both background and foreground modes. If you type 0 , you will have no foreground mode, because reading programs from disc requires at least one channel. When unsure of what you need, try 16 .

If you specified an unmapped system, SYSGEN asks:

- ***CORE STORAGE (IN THOUSANDS OF WORDS, 16-32)***

Type the amount of memory storage your system has, in multiples of 1024 words; e.g., type 20 if you have 20,480 words.

- ***NUMBER OF NOVADISK CONTROLLERS (0-2)***

A NOVADISK is a Model 6001-6008 fixed-head disc. There are two types of fixed-head discs; the other type is the Model 6063/6064, which SYSGEN asks about next. Answer with the number of 6001-6008 discs you want this system to support.

If you have 0 or 2 of these discs, SYSGEN skips the next question.

- **DEVICE PRIMARY ("0") OR SECONDARY ("1")?**

Answer 0) if your 6001-6008 disc is wired to the first device code; answer 1) for the second device code. The primary disc has device code 20g and disc-identifying mnemonic DK0; the secondary disc has device code 60g and mnemonic DK1.

- **NUMBER OF 6063/6064 DISK CONTROLLERS (0-2)**

The 6063/6064 is the other, newer type of fixed-head disc. Answer 0) , 1) , or 2) , depending on the number of *controllers* you have for 6063/6064 drives. Each controller can handle up to four drives.

If you have one 6063/6064 controller, SYSGEN asks:

- **DEVICE PRIMARY ("0") OR SECONDARY ("1")?**

Answer 0) if your 6063/6064 controller is connected to the first device code; answer 1) for the second device code. The first controller has device code 26g; it controls drives named DS0, DS1, DS2, and DS3. The second controller has device code 66g; it controls drives named DS4, DS5, DS6, and DS7.

- **NUMBER OF DEVICES FOR CONTROLLER #1 (1-4)**

Answer with the number of disc drives connected to the first controller.

If you specified two 6063/6064 controllers, SYSGEN repeats this question for the second controller.

- **NUMBER OF 6060/6061/6067/6122 DISK CONTROLLERS (0-2)**

Answer 0) , 1) , or 2) , depending on the number of controllers you have for 6060/6061/6067/6122 series disc drive consoles. These drives hold multiple-platter disc packs. The primary controller has device code 27g and controls consoles DZ0, DZ1, DZ2, and DZ3; the secondary controller has device code 67g and controls consoles DZ4, DZ5, DZ6, and DZ7.

If you answer 1) , SYSGEN wants to know:

- **DEVICE PRIMARY ("0") OR SECONDARY ("1")?**

Answer 0) if your 6060/6061/6067/6122 controller is wired to the first device code (27g); answer 1) for the second device code (67g).

- **NUMBER OF DEVICES FOR CONTROLLER #1 (1-4)**

Respond with the number of 6060/6061/6067/6122 disc consoles connected to the first controller.

If you specified two 6060/6061/6067/6122 controllers, SYSGEN repeats this question for the second controller.

- **NUMBER OF OTHER TYPES OF MOVING-HEAD DISK CONTROLLERS (0-2)**

This question covers the remaining models of discs. It includes all sealed moving-head discs, top-loading disc drives, and diskettes. Be sure to specify the number of non-6060 series controllers in the system, not the total of moving-head discs.

If you have no other types of moving-head disc, SYSGEN skips the next five questions. If you answer 1), SYSGEN requests:

- **DEVICE PRIMARY ("0") OR SECONDARY ("1")?**

Generally, your moving-head disc controller will be primary, so answer 0). If you know for certain that it is connected to the second controller, answer 1). The primary moving-head disc controller has I/O device code 33g and the disc-identifying mnemonics DP0, DP1, DP2, and DP3 for drives 1 through 4, respectively. The secondary controller has device code 73g and mnemonics DP4, DP5, DP6, and DP7 for the second set of devices 1 through 4, respectively.

- **NUMBER OF DEVICES FOR CONTROLLER #1 (1-4)**

Each sealed moving-head disc, each dual-platter top-loader disc subsystem, and each diskette drive counts as one device.

Give the number of drives connected to the first controller.

- **TOP LOADER(S)? ("0" = NO "1" = YES)**

If you have Model 6045, 6070, or 4234A top-loading cartridge disc drives connected to the first controller, answer 1); otherwise answer 0). These drives include a built-in nonremovable disc and your answer identifies the extra storage to SYSGEN. The removable disc has mnemonics DP0, DP1, DP2, or DP3; the fixed disc has the same mnemonic but with the suffix F; i.e., DP0F through DP3F.

If you specified two moving-head disc controllers, SYSGEN asks the two questions:

- **NUMBER OF DEVICES FOR CONTROLLER #2 (1-4)**

- **TOP LOADER(S) ("0" = NO "1" = YES)**

to which you respond as you did to the questions about the first controller. The second "other" type of disc controller has device code 73g. For the second controller, the removable disc has mnemonics DP4, DP5, DP6, or DP7; the fixed disc (if any) has the same mnemonics, but with the F suffix: DP4F through DP7F.

- **ENTER BAD BLOCK POOL SIZE IN BLOCKS (0-512)**

RDOS needs a bad block pool in memory to pass over unusable disc storage. The bad block pool must be large enough to hold the bad blocks for all discs on your system; e.g., if you have two top-loaders (four discs) and each disc has three bad blocks, the bad block pool must contain at least 12 blocks to allow all four discs to be initialized at the same time.

Ideally, you should enter the same value DKINIT assigned to the disc when you defaulted the DKINIT "DEFAULT REMAP AREA SIZE?" question. If you don't remember the DEFAULT size and DKINIT ran all patterns without an error, try 12) for each disc unless you have large discs. With one or more large discs (Model 6060/6061/6067/6122), try 60).

- **DUAL PROCESSORS (IPB)? ("0" = NO "1" = YES)**

Respond with 1 if your system has two computers connected by an Inter-Processor Buffer; otherwise type 0.

- **ENTER NUMBER OF STACKS (1-10)**

RDOS can concurrently operate a number of I/O peripheral devices equal to the number of stacks you select. One stack is minimum in an unmapped system; spooling requires an additional stack, and each multiple concurrent task requires another stack. (Spooling saves output intended for a slow peripheral, such as a line printer, on the disc until the peripheral device is ready to accept it.) In a mapped environment, you need one stack each for background and foreground program, one stack for spooling, and an additional stack for every task that will be running concurrently.

RDOS automatically allots two extra system buffers for the fourth and each additional stack.

If you are running Extended BASIC, you need at least two stacks in an unmapped system and three stacks in a mapped system. However, system efficiency increases substantially if you allocate additional stacks (five or more recommended in a mapped system) when supporting multiple BASIC terminals. See Table 11.N for stack recommendations.

Table 11.N System Stack Requirements

System	System Stacks	
	Minimum	Recommended
Unmapped	1	2
Mapped	2	3
Extended BASIC unmapped	2	4 or more
Extended BASIC mapped	3	5 or more
INFOS	3	5

- **ENTER NUMBER OF EXTRA CELLS (0-64)**

RDOS runs more efficiently if you specify two extra cells (data buffers of 16 memory words each) for each simultaneous spooling device, except the system console. For example, if you have a system with one paper tape reader, one paper tape punch, one line printer, and one magnetic tape controller (which may have multiple drives), you would specify eight extra cells. An INFOS system requires four cells in addition to spooling requirements.

- **TUNING ("0" = NO "1" = YES)**

RDOS provides a self-monitoring feature called tuning. If you type 1) , and later turn tuning on, RDOS will record how often it needs a system stack, cell or system buffer (see below) but cannot get one because not enough were allocated at SYSGEN time. This information is kept in disc file SYS.TU (or sysname.TU if you named your RDOS sysname). You can PRINT this file at any time; or, at some future time when you are generating a new RDOS system, you can tell SYSGEN to obtain a corrected number of stacks, cells, and buffers by analyzing this file, and to use the tuning values in place of your typed answers. This self-tuning feature is most useful for tailoring an RDOS system that will be dedicated to a particular application. When tuning is on, it consumes one system buffer. For further information on tuning, consult the *RDOS Reference Manual*.

If you request tuning, SYSGEN asks:

- **SHALL TUNING BE WITH ("1") OR WITHOUT ("0") OVERLAY REPORT?**

The overlay report is appended to disc file SYS.TU (or your systemname.TU). In this file, RDOS keeps count of the number of times it needs each system overlay but must read it in from the overlay file because it is not core-resident. SYSGEN cannot use the overlay report to generate a more efficient system. But you can examine the report and decide if any overlay files are so frequently needed that you should allocate extra buffer space (see below) for them. When tuning is on and you have chosen an overlay report, the overlay report feature uses two extra system buffers.

- **ENTER NUMBER OF EXTRA BUFFERS REQUIRED (0-63)**

Extra buffers allow disc data and overlay files, which would otherwise be swapped out to disc, to remain core-resident. The more extra buffers you allocate, the faster and more efficiently RDOS will run because disc swapping time is reduced. Each extra buffer takes an additional 270 words and reduces the amount of memory available for your program by that much.

RDOS automatically allots a minimum of six buffers, or two per stack, whichever is greater.

Block I/O operations (records that you read from, or write to disc in multiples of 256 words) reduce the need for extra buffers, because RDOS does not use buffers for these. Conversely, adding users to a multiterminal Extended BASIC system increases the need for extra buffers if you want to maintain reasonable system response at the terminals. If you are unsure of how many extra buffers to allocate, use Table 11.O as a guide.

Table 11.O Extra Buffer Guidelines

Memory Size	Type In
20K	0
24K	4
32K or more	8

You can then use tuning to pinpoint your requirements more precisely. Allocating more than 25 extra buffers does not measurably improve system performance.

- ***MAXIMUM NUMBER OF SUBDIRECTORIES/SUBPARTITIONS ACCESSIBLE AT ONE TIME (0-64)***

RDOS allows you to divide each physical disc (called a primary partition) into sections called subpartitions or secondary partitions. Each subpartition can have one or more subdirectories. You can address each of these "directories" from the console or from your programs, as if it were a self-contained disc drive.

The utility programs (Macroassembler, Text Editors, FORTRAN, etc.) do not require subdirectories.

For Extended BASIC the installation's System Manager usually assigns a fixed-length subpartition to each BASIC user; so normally your answer will be the maximum number of terminals the Extended BASIC system supports, plus one for the shared library (usually kept in a subdirectory) and one for each disc (itself a directory) that contains any or all of these.

- ***ENTER NUMBER OF CONTROLLERS FOR MTA (0-2)***

Be sure to enter here the number of magnetic tape controllers, not the number of tape drives. Each controller can support up to eight drives.

If you have one magnetic tape controller, SYSGEN asks:

- ***DEVICE PRIMARY ("0") OR SECONDARY ("1")?***

The first controller has I/O device code 22g and the tape drives have identifying mnemonics MT0 through MT7. The secondary controller had device code 62g and the tape drive mnemonics are MT10 through MT17. If you have two controllers, one is by definition primary and the other is secondary.

SYSGEN then asks you to:

- ***ENTER NUMBER OF DEVICES FOR CONTROLLER #1 (1-8)***

If you have a second controller, SYSGEN asks:

- ***ENTER NUMBER OF DEVICES FOR CONTROLLER #2 (1-8)***

Key in the number of magnetic tape drives attached to the respective controllers.

- ***ENTER NUMBER OF CONTROLLERS FOR CTA (0-2)***

Cassette controller 1 has device code 34g and the cassette drives have identifying mnemonics CT0 through CT7. Controller 2 has device code 74g and the cassette drive mnemonics are CT10 through CT17.

If you specify only one controller, SYSGEN wants to know:

- *DEVICE PRIMARY ("0") OR SECONDARY ("1")?*

Then for one or two controllers, SYSGEN requests you to:

- *ENTER NUMBER OF DEVICES FOR CONTROLLER #1 (1-8)*
- *ENTER NUMBER OF DEVICES FOR CONTROLLER #2 (1-8)*

Respond in each case with the number of cassette drives attached to the controller.

- *AUTO RESTART ON POWER FAIL? ("0" = NO "1" = YES)*

Specify whether or not you want to have this option.

- *OPERATOR MESSAGES ("0" = NO "1" = YES)*

If you will be executing programs that use RDOS system or task calls to send messages to and retrieve messages from the system console, then answer 1). Neither the system utilities nor Extended BASIC need this feature.

- *RTC? ("0" = NO "1" = YES)*

Specify whether or not you have Real-Time Clock hardware.

If you have a clock, SYSGEN asks the next two questions.

- *DEVICE PRIMARY ("0") OR SECONDARY ("1")?*

The primary Real-Time Clock has I/O device code 14g; the secondary clock has code 54g. In either case, SYSGEN will ask you this question and the following question for only one clock, and RDOS will see only the one clock you identify during SYSGEN.

- *ENTER RTC FREQ (1 = 10HZ, 2 = 50HZ, 3 = 60HZ, 4 = 100HZ, 5 = 1000HZ)*

Unless you want a special frequency for programs you code yourself, answer 1) for a 10 Hz clock. Extended BASIC, COBOL, and RPG expect and use 10 Hz frequency. If you are synchronizing with the ac line frequency, then type 2) if you have 50 Hz power and 3) if you have 60 Hz power.

- *ENTER NUMBER OF PTR (0-2)*

If you specify one paper tape reader, it has I/O device code 12g and identifying mnemonic PTR (filename \$PTR); the second reader has code 52g and mnemonic PTR1 (filename \$PTR1).

- *ENTER NUMBER OF PTP (0-2)*

The first paper tape punch has device code 13g and identifying mnemonic PTP (filename \$PTP); the second has code 53g and mnemonic PTP1 (filename \$PTP1).

- *ENTER NUMBER OF LPT (0-2)*
The first line printer has device code 17g and identifying mnemonic LPT (filename \$LPT); the second has code 57g and mnemonic LPT1 (filename \$LPT1).
If you have one or two printers, SYSGEN asks two or four of the following questions, respectively:
 - *ENTER COLUMN SIZE DEVICE #1 (80 OR 132)*
Specify the column size of your first printer.
 - *DATA CHANNEL LINE PRINTER? ("0" = NO "1" = YES)*
If your first (or only) line printer is a data channel printer, type 1. Otherwise, type 0.
 - *ENTER COLUMN SIZE FOR DEVICE #2 (80 OR 132)*
Specify column size for \$LPT1.
 - *DATA CHANNEL LINE PRINTER? ("0" = NO "1" = YES)*
Answer 1 if your second printer is a data channel printer; otherwise 0.

Next, SYSGEN asks:

- *ENTER NUMBER OF CDR (0-2)*
The first punched or mark-sense card reader has device code 16g and identifying mnemonic CDR (filename \$CDR); the second has code 56g and mnemonic CDR1 (filename \$CDR1).
- *ENTER NUMBER OF PLT (0-2)*
The device code for the first incremental plotter is 15g and its identifying mnemonic is PLT (filename \$PLT); the second plotter has code 55g and mnemonic PLT1 (filename \$PLT1).
- *ENTER NUMBER OF MCA (0-2)*
If you answer 2, the first Multiprocessor Communications Adapter has device code 06g and 07g and mnemonics MCAT and MCAR for transmitter and receiver, respectively. The second adapter has codes 46g and 47g, and mnemonics MCAT1 and MCAR1.

If you specify only one MCA link, then SYSGEN asks:

- *DEVICE PRIMARY ("0") OR SECONDARY ("1")?*
To determine which set of codes and mnemonics to assign to the link.

- *QTY?* ("0" = NO "1" = YES)

Answer 1) only if you want the new system to support a Type 4060 Asynchronous Data Multiplexor (but, for BASIC systems, see note under "Multiplexors," earlier). Answer 0) if you do not want 4060 support; SYSGEN then skips to the "ULM" question.

- *DEVICE PRIMARY ("0") OR SECONDARY ("1")?*

The primary 4060 is on device code 30g and has mnemonic QTY; the secondary unit is on code 70g and has mnemonic QTY1. The multiplexed lines have filenames QTY:xx or QTY1:xx, primary and secondary, where xx is the line number, 0 to 63.

After you answer this question, SYSGEN skips to the "NUMBER OF LINES" question.

- *ULM?* ("0" = NO "1" = YES)

A ULM (Universal Line Multiplexor) is a multiplexor that fits into a computer chassis instead of a separate communications chassis. A ULM can handle up to four asynchronous full-duplex lines or up to eight half-duplex asynchronous lines; it can also handle two synchronous lines. RDOS supports only the asynchronous lines. To support the synchronous lines, you must use other DG software, like the Communications Access Manager, with RDOS.

If you want the new system to support an ALM multiplexor or no multiplexor, answer 0) ; SYSGEN then skips to the "ALM" question. To have it support a ULM, answer 1) ; but, for BASIC systems, see note under "Multiplexors," earlier. If you specify a ULM, SYSGEN asks:

- *DEVICE PRIMARY ("0") OR SECONDARY ("1")?*

The primary ULM is on device code 34g, the secondary is on code 74g. ULM mnemonics are ULM and ULM1, for primary and secondary devices; but the filenames of multiplexed lines are QTY:xx and QTY1:xx, respectively, where xx is the line number.

SYSGEN now asks about line speed:

- *LINE SPEED (BITS/SEC)?* ("1" = 19200 "2" = 50 "3" = 75 "4" = 134.5 "5" = 200 "6" = 600 "7" = 2400 "8" = 9600 "9" = 4800 "10" = 1800 "11" = 1200 "12" = 2400 "13" = 300 "14" = 150 "15" = 110)

Your answer selects the baud line speed for *all* asynchronous lines. (But it will not override the line speed set by hardware jumpers, if any.) Generally, a higher line speed means faster response to multiplexed terminals, but it also means that the main processor must service more interrupts in a given amount of time. If there are too many interrupts at a time, the system will report input buffer

overflow errors, and input characters may be lost. Good general answers are 7 (2400), 9 (4800), or 8 (9600). For minimum screen service time, you can try a very high baud rate; then if input characters are lost, generate another RDOS system with a slower rate.

Alternatively, later, you can select a speed for *each* line by editing the ALM/ULM multiplexor source file, ALMSPD.SR, with a text editor, then assembling the edited ALMSPD.SR file with the macroassembler. Future SYSGENs will then use your custom ALMSPD binary file to implement the line characteristics you want — because the line speed declared in the ALMSPD file overrides the speed you give to SYSGEN.

After you answer this question, SYSGEN skips to the “ANY MODEMS?” question.

- *ALM? (“0” = NO “1” = YES)*

Answer 1 if you want the new system to support a Type 4255 through 4258 Asynchronous Line Multiplexor (but, for BASIC systems, see the note under “Multiplexors,” earlier). If you don’t want ALM support, SYSGEN skips to the “SECOND TTY” question. If you do want it, SYSGEN asks:

- *DEVICE PRIMARY (“0”) OR SECONDARY (“1”)?*

The primary ALM is on device code 34g and has the mnemonic ALM; the secondary ALM is on code 74g and has the mnemonic ALM1. The filenames of ALM lines are QTY:xx and QTY1:xx for the first and second ALM, where xx is a line number from 0 to 63.

- *ENTER ALM CLOCK FREQUENCY (0-3)*

An ALM has four clocks, and each is jumpered for a specific line speed. Choose the clock whose frequency matches the baud rate of your terminals. Often, DG jumpered the ALM clocks according to customer specification; but, if you are unsure of what clock to specify, try 0 .

Later, you can select a specific clock for *each* line by editing the multiplexor parameter source file, ALMSPD.SR, with a text editor, then assembling the edited ALMSPD.SR file with the macroassembler. Future SYSGENs will then use your custom ALMSPD binary file to implement the line characteristics you want — because the clock specification declared in the ALMSPD file overrides the clock you give to SYSGEN.

If you answer 1 to either the ULM or ALM question, SYSGEN asks:

- *ARE THERE ANY MODEMS? (“0” = NO “1” = YES)*

Modems are beyond the scope of this course; however, information concerning system generation with modems can be found in Appendix D.

If you answer 1 to any of the QTY, ALM or ULM questions, SYSGEN asks:

- *NUMBER OF LINES? (1-64)*

Enter the number of lines connected to your multiplexor. The driver has been written to ignore I/O activity on lines beyond the number you SYSGEN. When SYSGENing ULM lines in your system do not specify more than 16 lines.

SYSGEN now asks about interrupt characters for your multiplexed lines.

- *USE DEFAULT ALM/QTY INTERRUPT CHARACTERS ("0" = NO "1" = YES)*

The default interrupt characters for multiplexed lines are CTRL-A and CTRL-C. If you want users on your multiplexed lines to use these as interrupts, type 1). To select one or two different interrupt characters, type 0). Multiuser Extended BASIC systems require ESC (ASCII 27 in decimal) as one of the two interrupt characters.

If you type 0), SYSGEN asks for the new characters:

- *FIRST CHARACTER (ASCII DECIMAL CODE OR "128" = NONE)*

Type in the *decimal* code of the interrupt character that will replace CTRL-A; or type 128) if you want only one character or none.

- *SECOND CHARACTER (ASCII DECIMAL CODE OR "128" = NONE)*

Respond with the decimal code of the interrupt character that will replace CTRL-C, or type 128) to omit a second interrupt character.

- *NUMBER OF NULLS AFTER CARRIAGE RETURN? (0-256)*

Under some circumstances, certain printing consoles may lose transmitted characters as the print head returns to column 0. Should this happen, you can use this question to specify enough nulls to allow the head to catch up. For your first system, try 0); then, if you lose characters from remote terminals, try adding nulls in increments of three.

- *SECOND TTY? ("0" = NO "1" = YES)*

Answer 1) if you have a console connected to the second teletypewriter interface. Such a console is independent of multiplexors; a system can have one primary console or a primary and secondary console with or without a multiplexor. The device codes and filenames of the secondary console are 50g and \$TTI1 for input and 51g and \$TTO1 for output.

- *CORE DUMP FACILITY? ("0" = NO "1" = LPT "2" = MTA "3" = 6030 "4" = 6097)*

If the system comes down unexpectedly, the core dump program can copy the computer's memory state to whatever device you specify. You can choose only one answer. Type 0) if you don't want the core dump; 1) to dump to the line printer; 2) to dump to mag tape drive number 3 (the dump program gives you

a chance to dial 3 before you dump); 3) to dump to single-density diskette number 3 (the dump program gives you a chance to dial 3 before you dump); or 4) to dump to double-density diskette.

If you answer 1) and you have not SYSGENed any line printer, SYSGEN will ask if your line printer is a Data Channel Line Printer. Line printer dumps assume the primary line printer. Answer according to your system.

If you answer 2) the program asks whether the device is primary or secondary; answer 0).

If you answer 3) or 4) to the core dump question, the program asks whether the dump should go to the primary or secondary controller. Answer according to your system.

If you answer 4) to the core dump question, the program will ask for the unit number that will receive the core dump. Answer according to your system.

The core dump question is the last in the SYSGEN dialog. SYSGEN now selects the modules for the new system from the SYSGEN libraries, and tells the Relocatable Loader to create the new system. The whole process takes a few minutes, so don't be alarmed at the delay. Soon, SYSGEN will return control to the CLI, which issues the prompt:

R

This indicates that your new system has been built.

The SYSGEN program itself does not build the new system. After you answer the last question, SYSGEN stores the system-creating command line in special file CLI.CM; then SYSGEN tells RDOS to execute the contents of file CLI.CM. This includes the Loader command that builds the new system. If you're curious about the system-creating command line, you can TYPE CLI.CM.

At this point you are still running under the starter system, since you have just generated your tailored system but haven't yet bootstrapped it into operation.

The bootstrap program looks for your system in the primary partition, but you have just generated it in a subdirectory called SYSGEN. Now you will have to create links in the primary partition to the system's save and overlay file in the subdirectory SYSGEN. Type:

DIR %MDIR%)

R

LINK SYS.SV SYSGEN:SYS.SV) (or substitute your system's
R name for SYS)

LINK SYS.OL SYSGEN:SYS.OL)

R

Bootstrapping Your Tailored RDOS System

Now you're ready to start up your tailored system. Of course, you can do this by releasing the disc and using program load, as you did previously when you bootstrapped the RDOS Starter System. But a better way is simply to type:

```
BOOT SYS ! (or equivalent filename)
MASTER DEVICE RELEASED
type RDOS REV XX
DATE (M/D/Y)?
```

As you have done before, provide the date and time:

```
DATE (M/D/Y)? 1 10 79 !
TIME (H:M:S) 17 50 !
R
```

Congratulations. Your tailored RDOS is now running.

If the new system doesn't come up, you may or may not receive an explanatory error message. Bring up the starter system, `BOOTSYS` or `FBOOTSYS`, as described at the beginning of this section. Type `DELETE/V SYS.(LM,SG) !` to delete the load map and dialog files, and execute `SYSGEN` again, using the same *sysname* to delete the defective system files. In the `SYSGEN` dialog, correct the error that prevented the new system from running, if the error message informed you what the problem was. Then `BOOT` the new system as above.

You should next print out and save the load map and `SYSGEN` dialog, so give the command

```
PRINT SYS.<SG LM> !
```

(or use the filename you substituted from `SYS`) to get a listing on the line printer. If you have no line printer, key

```
TYPE SYS.<SG LM> !
```

(or your equivalent) for a listing on the system console teleprinter.

Both the `SYSGEN` dialog and load map are important. The `SYSGEN` dialog is your record of the hardware and software features for which you configured RDOS; you can also use the disc stored `SYS.SG` (or equivalent) file to tune your RDOS system. Data General may from time to time issue corrections to RDOS as binary-word patches, and when you patch, you will need the load map to identify where on the disc the patch goes.

When you have an RDOS system running, you can invoke `SYSGEN` at any time to generate a new system. You might want to generate a new system to manage a different application, or to tune an existing RDOS system.

Updating Your Tailored System

This section assumes that you have just generated a tailored operating system and have booted that system. The CLI "R" prompt indicates that your system is up and running.

Data General is continuously maintaining RDOS. Major revisions, minor revisions, and updates all improve its operation. Each new revision and update has an associated number. For example:

RDOS REV 6.61

Update Number
Minor Revision Number
Major Revision Number

Load and generate a version with major and minor revision numbers:

```
RDOS REV 6.60
```

Then, after SYSGEN, add an update:

```
RDOS REV 6.61
```

Directions similar to the following are supplied with update software:

To install an update:

1. Mount update mag tape or insert update diskette.
2. Create a subdirectory to hold the update files, and then make the new subdirectory your current directory:

```
CDIR RDOSUD661;DIR RDOSUD661
```

3. Load the file named UPDATE contained on the update mag tape or diskette. To do this, use the commands from the set below, which match the medium you have:

From magnetic tape:
LOAD/V MTx:0 UPDATE!

where x is the unit number the tape is on.

From diskette: (*Note: Disable write protect by covering the write protect hole with opaque tape.*)

```
DIR DPx;MOVE/V RDOSUD661 UPDATE;DIR RDOSUD661!
```

where x is the unit number of the diskette drive.

4. Print or type out the instructions in the file UPDATE.
5. Follow the instructions given in UPDATE to load the remaining update files. (An example of a portion of an UPDATE file follows. Always follow the directions in the UPDATE file supplied with your update software. Use the following only as an example.)

How to Load the Update Files

1. CREATE A SUBDIRECTORY TO CONTAIN THE UPDATE FILES AND MAKE IT YOUR YOUR CURRENT DEFAULT DIRECTORY.

NOTE: IF YOU FOLLOWED THE INSTRUCTIONS ON THE UPDATE NOTICE, YOU WILL HAVE ALREADY PERFORMED THESE STEPS.

EXAMPLE:

```

R                                     <CLI READY>
CDIR RDOSUD661                       <CREATE UPDATE SUBDIRECTORY>
-----
R                                     <CLI READY>
DIR RDOSUD661                         <MAKE IT CURRENT DEFAULT>
-----
R                                     <CLI READY>

```

2. LOAD THE APPROPRIATE UPDATE FILES (ACCORDING TO YOUR SYSTEM).

- A) FOR MAGNETIC TAPE-
FROM MTX, WHERE X = UNIT NUMBER WHERE UPDATE TAPE RESIDES:

EXAMPLE:

```

R                                     <CLI READY>
INIT MTX                               <INIT MAG TAPE UNIT>
-----
R                                     <CLI READY>
LOAD/U MTX:0                          <FILES LOADED AND LISTED>
-----
R                                     <UPDATE FILES LOADED>

```

- B) FOR DISKETTE-
FROM DPX, WHERE X = UNIT NUMBER WHERE UPDATE DISKETTE RESIDES:

EXAMPLE:

```

R                                     <CLI READY>
DIR DPX                               <MAKE UPDATE DISKETTE CURRENT
-----                                DEFAULT DIRECTORY>
R                                     <CLI READY>
MOVE/U RDOSUD661 ^                   <FILES MOVED AND LISTED>
-----
#RDOS.PF
-----
R                                     <UPDATE FILES MOVED>

```

How to Apply RDOS Patches

**N.B. : RDOS PATCHES MUST BE APPLIED TO EVERY SYSTEM THAT IS
SYSGENED.**

PATCHING YOUR RDOS SYSTEM INVOLVES THE FOLLOWING GENERAL STEPS:

1. MAKE THE DIRECTORY IN WHICH YOU HAVE YOUR RDOS LIBRARIES ("SYSGEN" IN OUR EXAMPLE) YOUR CURRENT ONE.
2. SYSGEN A NEW SYSTEM USING THE LIBRARIES IN THIS DIRECTORY. BE SURE TO REQUEST A SYSTEM LOAD MAP.
3. LINK TO THE APPROPRIATE PATCH FILE.
4. LINK TO THE UTILITY PATCH.SU.
5. INVOKE THE PATCH UTILITY.

ASSUME YOU HAVE SYSGENED AN NRDOS SYSTEM CALLED "NSYS", WHOSE LOAD MAP NAME IS "NSYS.LM". THE FOLLOWING IS AN EXAMPLE OF WHAT THE PATCH PROCEDURE WOULD BE.

EXAMPLE:

```

R                               <CLI READY>
DIR SYSGEN                      <GET TO "SYSGEN">
-----
R                               <CLI READY>
LINK NRDOS.PF RDOSUD661:NRDOS.PF <LINK TO PATCH FILE>
-----
R                               <CLI READY>
LINK PATCH.SU UTIL:PATCH.SU    <LINK TO PATCH.SU>
-----
R                               <CLI READY>
PATCH NRDOS.PF/P NSYS/S NSYS.LM/L <INVOKE PATCH>
-----
R                               <PATCHES BEING INSTALLED>
                               <SYSTEM PATCHED>

```

6. THE PATCH INSTALLATION PROCESS MAY CONTINUE BY ASKING FOR FURTHER INFORMATION. FOR EXAMPLE, THERE MAY BE A PATCH WHICH ONLY A CERTAIN SET OF USERS WOULD LIKE INSTALLED. IN THIS CASE, YOU MUST RESPOND WITH A '1' (YES) OR '0' (NO) ANSWER TO THE QUESTION.
 7. YOU MUST SAVE A COPY OF YOUR SYSGEN DIALOGUE, LOAD MAP AND PATCH DIALOGUE (.PD) FILE IN CASE YOU SUBMIT AN STR OR CORE DUMP TO DATA GENERAL FOR ANALYSIS. THIS WILL INSURE THAT DATA GENERAL CAN TAKE YOUR PATCHES INTO ACCOUNT WHEN ANALYZING YOUR SYSTEM.
 8. YOU SHOULD CONTINUE TO UPDATE YOUR RDOS SYSTEMS AS THEY ARE GENERATED. THIS CAN BE DONE EASILY BY KEEPING THE DIRECTORY RDOSUD661 ON DISK UNTIL THE NEXT UPDATE OR SYSTEM REVISION IS ISSUED.
- PROBLEMS/STATUS

Module 11

Exercise 2

True or False?

1. _____ Before you can put any RDOS system on a disc, you must first initialize the disc with a program called the Disc Initializer.
2. _____ The Bootstrap Root is a program that helps bring RDOS or other programs into main memory for execution.
3. _____ You use the Starter System to load "release" software onto your disc.
4. _____ All the utility programs are loaded from the release medium into the master directory.
5. _____ The command that you use to invoke SYSGEN is the same, no matter what type of computer you are using.
6. _____ As long as you generate your system in a subdirectory called SYSGEN, it is not necessary to create links to it.
7. _____ The instructions for patching your system are supplied with the update software.
8. _____ It is usually unnecessary to create links when you update your system.

Module 11

Exercise 2 Answers

1. True
2. True
3. True
4. False
5. False
6. False
7. True
8. False

Files Created during System Generation

In the subdirectory SYSGEN:

systemname.SV (Executable Tailored RDOS System)

systemname.OL (Tailored Overlays)

systemname.LM (System Load Map)

systemname.SG (System Generation Dialog)

Tuning

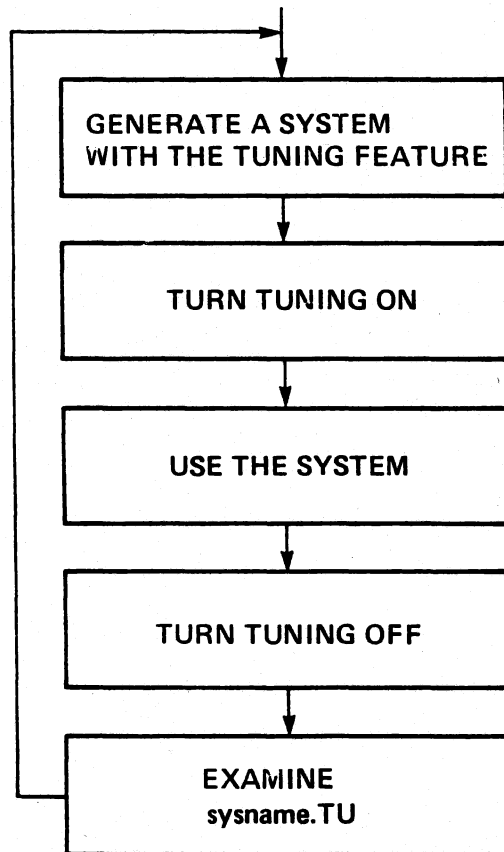

CS-01153

Figure 11.8 Tuning

TUON

Format — TUON

Function — Start recording, in the tuning file, the number of system requests and system failures for:

- Any stack
- Any cell
- Any buffer
- Any system overlay

The tuning file has the name of the current operating system with the .TU extension. If it doesn't exist, TUON creates it.

TUOFF

Format — TUOFF

Function — Stop recording in the tuning file. This command does not delete the tuning file.

TPRINT

Format — TPRINT [*sysname*]

Function — Print the tuning file for *sysname*. You need not specify *sysname*.

If you omit switches, tuning file information is printed on the console and information on overlays is omitted.

Global Switches

/L — Print the tuning file on the line printer.

/O — Print the overlay frequency report.

- Before turning tuning on, delete tuning file of previous system with the same name.
- Do not delete tuning file while tuning is on.

Example Tuning Report

SYSTEM TUNING REPORT FOR MY2SYS					12/06/79	00:21:44
	NUMBER IN SYSTEM	TOTAL REQUESTS	NUMBER OF FAULTS	PERCENTAGE FAULTED		
STACKS	4	8463	0	0 %		
CELLS	19	9035	0	0 %		
BUFFERS	15	46021	1349	3 %		
OVERLAYS	64	10909	518	5 %		

OVERLAY TUNING REPORT FOR MY2SYS					12/06/79	00:21:44
	NUMBER OF REQUESTS	NUMBER OF FAULTS	PERCENTAGE FAULTED	PERCENTAGE OF TOTAL FAULTS		
OVERLAY # 0	1903	21	1 %	4 %		
OVERLAY # 1	1168	20	2 %	4 %		
OVERLAY # 2	120	26	22 %	5 %		
OVERLAY # 3	40	21	52 %	4 %		
OVERLAY # 4	43	22	51 %	4 %		
OVERLAY # 5	751	17	2 %	3 %		
OVERLAY # 6	74	14	19 %	3 %		
OVERLAY # 7	759	16	2 %	3 %		
OVERLAY # 10	17	16	94 %	3 %		
OVERLAY # 11	135	25	19 %	5 %		
OVERLAY # 12	3	2	67 %	0 %		
OVERLAY # 13	3	2	67 %	0 %		
OVERLAY # 14	40	17	42 %	3 %		
OVERLAY # 15	531	6	1 %	1 %		
OVERLAY # 16	3523	22	1 %	4 %		
OVERLAY # 17	19	18	95 %	3 %		
OVERLAY # 20	0	0	0 %	0 %		
OVERLAY # 21	0	0	0 %	0 %		
OVERLAY # 22	0	0	0 %	0 %		
OVERLAY # 23	0	0	0 %	0 %		
OVERLAY # 24	319	59	18 %	11 %		
OVERLAY # 25	73	10	13 %	2 %		
OVERLAY # 26	0	0	0 %	0 %		
OVERLAY # 27	8	8	100 %	2 %		

Tuned SYSGEN

1. Start recording information in the tuning file `systemname.TU` (i.e., `OLDSYS.TU`).

```
TUON )
R
```

2. Run your system long enough to give the tuning file adequate information on your application's requirements. Take all the time you need (even days or weeks).

3. Turn off tuning.

```
TUOFF )
R
```

4. Make the system generation subdirectory the current directory. Link to the tuning file, which resides in the master directory.

```
DIR SYSGEN )
R
LINK OLDSYS.TU/2 )    (or equivalent system name)
R
```

5. Generate a tuned system:

General Form:

```
{BSYSGEN }
{NSYSGEN } newsysname/S olddialogfile/A newdialogfile/V tuningfile/T loadmapfile/L
{SYSGEN }
```

Example:

```
NSYSGEN NEWSYS.<SV/S,SG/V,LM/L> OLDSYS.<TU/T.SG/A> )
```

6. Wait for the R prompt then get a copy of the new SYSGEN dialog.

```
R
PRINT NEWSYS.SG )    (or TYPE NEWSYS.SG)
R
```

7. Be sure to delete the old tuning report.

```
DELETE/V OLDSYS.TU )
DELETED OLDSYS.TU
R
```

8. Now create links in the master directory to the `.SV` and `.OL` files.

```
DIR %MDIR% )
R
LINK NEWSYS.SV SYSGEN:NEWSYS.SV )
R
LINK NEWSYS.OL SYSGEN:NEWSYS.OL )
R
```

9. Now you can boot the new system.

```
BOOT NEWSYS )
```

Abnormal Conditions

Human Errors

Someone turns off the power to the CPU or master directory disc drive, or presses the front panel STOP before releasing the master directory.

System Errors

Trap — Violation of MAP, system displays message.

Exceptional Status* — System displays an error message.

Crash* — No message displayed.

**May require full initialization of all discs that were initialized at the time of the failure.*

Loss of Disc Integrity

- Incorrect information in MAP.DR or SYS.SR.
- Prevent catastrophic loss of data by backing up disc.

Failure to Release the Master Directory

Problem — Abnormal shutdown (power off or STOP before releasing master directory).

Solution

1. Rehome the Disc Read/Write Heads. Toggle the disc switch to go from READY state, to LOAD state, back to READY state.
2. Reboot: *PARTITION IN USE — TYPE C to CONTINUE*
C
3. CLEAR

Format — CLEAR [*filename*₁ . . . *filename*_n]

Function — Clear the file use count to zero in one or more *filenames*. The command can be issued only from the background CLI when no foreground program is running.

Global Switches

/A — Clear use count in all files in current directory except CLI.OL, CLI.ER, sysname.OL, sysname.TU and LOG.CM.

/D — Set device use counts to zero (RDOS).

/V — Verify files cleared on the console. (Used with /A.)

Exceptional Status and Crash Information Needed by Data General

- Record the machine state (ac, pc, carry, ion, etc.).
- Produce a core dump to magnetic tape or diskette.
- Complete a software trouble report (STR).
- SYSGEN dialog.
- Update dialog.
- System load map.
- Documentation describing events prior to the failure.

After System Error

1. Rehome disc heads.
2. Reboot the system.
3. Clear file use counts.

Producing a Core Dump

Line Printer Dump

- Press CONTINUE twice.

The line printer dump has three parts: the left column shows a memory address, the middle eight columns show the contents of each word in the address, and the right column shows the ASCII value (if any) of each byte in the address.

Magnetic Tape Dump

To dump to magnetic tape, follow these steps:

1. Select unit 3 on a magnetic tape drive, and make sure no other drive has this number. Mount a blank tape (300 ft or more), with ring in, on this drive. Then press drive switches LOAD and ON LINE.
2. Press the CPU switch CONTINUE. The dump program then displays the message READY?.
3. Press the CPU switch CONTINUE again. The dump program then copies all memory address to the tape, and displays the message DONE, then READY on the console. To stop the program, press CPU switch STOP; to produce another dump, RESET and UNLOAD the tape with drive switches, mount another tape and execute Steps 2 and 3 again.
4. If you have forgotten a step, the program displays the message ERROR, then READY?. Execute the step and press the CPU switch CONTINUE.

The magnetic tape cannot be copied under RDOS.

Diskette Dump

1. If you are using single-density diskettes, select unit 3 on a diskette drive, and make sure no other drive connected to this controller has the same number. If you are using double-density diskettes you will use the unit number you requested at SYSGEN.
2. Tape the write-protect hole of a Data General diskette (or other diskette that has been hardware formatted); insert this diskette in the drive. Shut the door and turn the diskette drive ON.
3. Press CPU switch CONTINUE. The dump program then displays the message READY?.
4. Press the CPU switch CONTINUE again. The dump routine copies memory to the diskette; if it displays the messages DONE and READY, go to Step 6.
5. If all addresses won't fit on one diskette, the program displays the message REPLACE, then READY?. Open the diskette door, remove the diskette, insert another hardware-formatted diskette in the drive, and close the door. Press the CPU switch CONTINUE. The program then copies the rest of memory to the second diskette, and displays the message DONE and READY?.
6. The diskette dump is complete. To stop the program, press the CPU switch STOP; to produce another dump, remove the diskette, then execute Steps 3, 4, and 5 again.
7. If you have forgotten a step, the program displays the message ERROR, then READY?. Execute the step and press CONTINUE.

The diskette dump cannot be copied under RDOS.

Loss of Disc Integrity

- Incorrect information written into MAP.DR or SYS.DR.
 - Prevention: Back up disc data onto another storage medium.
BURST — Back up a disc onto mag tape or another disc.
DBURST — Back up disc onto diskettes.
1. Read either:
The Disc Back-up Utility — BURST, beginning on page 11-77.
The Disc Back-up Utility — DBURST, beginning on page 11-80.
 2. Do the Lab Exercise.
 3. Take the Module Quiz.

Stop the audiocassette tape now, and read the text and do the lab and Module Quiz as instructed.

The Disc Back-up Utility — BURST

BURST is a standalone utility for dumping disc images to tape and reloading them. It can also copy from disc to disc. Since it bypasses the RDOS file system, it offers greater speed than the CLI DUMP or FDUMP.

Commands

- DUMP — Dump a disc image to tape.
- LOAD — Load a disc image from tape.
- DUPLICATE — Write a disc image to another disc of the same type.
- VERIFY — Read a tape dump to verify that there are no bad tape records.

BURST will not:

- List dumped files.
- Selectively dump or load files.
- Load a disc image from one type of disc to another type.

To determine approximately how many tape reels you will need to dump your disc, enter the DISK command while running under the CLI. Use the information returned and the table below to determine the approximate number of tape reels required.

Table 11.P Amount of Tape Needed to Back Up Your Disc

Tape Reel Length (ft)	Number of Disc Blocks (used and allocated)
300	5,600
600	11,200
2,400	44,800

Instructions for Use

- BURST resides in the UTIL directory. Create a link to it in the master directory.

```
DIR %MDIR% |
R
LINK BURST.SV UTIL:BURST.SV |
R
```
- Boot BURST either *a.* from the CLI, or *b.* from Cold Start.
 - a. Type: `BOOT BURST |`
 - b. Press program load on front panel, then type BURST in response to `FILENAME?`

In either case, BURST will display:

**** DISK BACKUP/RESTORE — REV. xx.xx ****
COMMAND?

- Respond with the appropriate command (DUMP, LOAD, DUPLICATE, VERIFY) followed by a carriage return.

Using the Dump Command

- Respond to the *COMMAND?* question by typing DUMP. The program asks:
INPUT DISK UNIT?
- Respond with the unit name (i.e., DP0, DZ3, DPOF). The program then asks:
MAGTAPE UNIT?
- Respond with the name of the unit on which you wish to dump the disc (i.e., MT0). The program will then ask:
SECOND MAGTAPE UNIT (HIT RETURN FOR NONE)?
- If you are dumping to alternate mag tape units, enter the second unit name (i.e., MT1). If you are dumping to a single unit press RETURN. The program will then prompt:

I AM ABOUT TO COPY Dxx TO MTx:n.
SHALL I CONTINUE?

- If you are entered the proper units type Y, if not, type any other key to restart.
- If you hit Y, the program begins dumping your disc to tape.
- If you are dumping to a single unit, when the end of the tape is detected, the program will rewind the tape and prompt:

MOUNT NEXT REEL, STRIKE KEY WHEN READY

When the tape is finished rewinding, replace it with the next reel and strike any key to continue the dump.

- If you are dumping to alternate units, when the end of the first tape is detected, the program will rewind the reel and begin dumping to the alternate unit. When the end of the tape is detected on the alternate unit, the program will expect the next reel to be ready on the primary unit. If the first tape was left on the primary unit, the program will overwrite it. For this reason you should monitor your backup carefully, if you are dumping to multiple units.
- When the dump is complete, the program will issue the message:

*****DISK TO TAPE DUMP COMPLETE*****

Using the Load and Duplicate Commands

These commands cause the program to ask roughly the same questions as the dump command does, but in a different order. Respond appropriately as described above. If during the LOADING process, BURST specifies that it was unable to restore certain blocks on the disc, record the list of these block numbers and use another utility program OWNER.SV to determine which files were using these blocks on the disc.

Using the Verify Command

This command is used to test your dump tape and report any bad records. The use of this command is valid only if you leave the DUMPed disc in its drive, and perform the verification immediately after your dump. If you use this command, it will greatly improve your chances of LOADING your dump without errors.

Note: If you have only one disc available for use in your system, and that disc's structure is destroyed, you should bring up BOOTSYS on your disc by loading file 2 on your release tape and request a full INIT. When BOOTSYS and the CLI have been loaded, you may load BURST off of file 6, and boot BURST to load your backup. (See your release notice for a list of error messages issued by BURST.)

Using OWNER.SV

OWNER is a standalone utility for use with BURST for determining to which files any blocks lost during a BURST restore belong.

- OWNER resides in the UTIL directory. Create a link to it in the master directory.

```
DIR %MDIR% |
```

```
R
```

```
LINK OWNER.SV UTIL:OWNER.SV |
```

```
R
```

- Boot OWNER either *a.* from the CLI, or *b.* from Cold Start.
 - a. Type: `BOOT OWNER`
 - b. Press program load on front panel, then type OWNER in response to `FILENAME?`

In either case, OWNER will display:

```
**DISK BLOCK OWNER — REV xx.xx **  
COMMAND?
```

- Respond by typing OWNER. The program will then ask:

```
INPUT DISK UNIT?
```
- Type the name of the disc on which you wish to determine which files have been degraded by the loss of blocks during disc restoration. The program will then ask for the lost blocks you want to check. The program asks:

```
BLOCK NUMBER (TYPE RETURN TO STOP)?
```
- Enter a block number. The above question is repeated until you press RETURN without a preceding block number. A maximum of 20 block numbers may be entered at one time. The program will display the files to which the bad blocks belong.

The Disc Back-Up Utility — DBURST

DBURST is a standalone back-up utility for disc Models 6099 and 6103 using diskettes as a back-up medium. You may use this program to save the contents of your 6099/6103 fixed disc on either single- or double-density diskettes.

Commands

DUMP — Dump a disc image to tape.

LOAD — Load a disc image from tape.

OWNER — Report the name of the file in which a bad block was found.

DBURST will not:

- List dumped files.
- Selectively dump or load files.
- Load a disc image from one type of disc to another type.

The table below lists the number of diskettes you will need to back up your disc.

Table 11.Q Number of Diskettes Needed to Back Up Your Disc

To Back Up	Number of 6030 Diskettes	Number of 6097 Diskettes
6099	42	10
6103	84	20

Due to the large number of diskettes required, it is suggested that they be numbered and used in numerical order to produce the back-up dump. The diskette must be loaded in exactly the same sequence to restore the disc, if it should be necessary.

Instructions for Use

- DBURST resides in the UTIL directory. Create a link to it in the master directory.

```
DIR %MDIR% |
```

```
R
```

```
LINK DBURST.SV UTIL:DBURST.SV |
```

```
R
```

- Boot DBURST either *a.* from the CLI, or *b.* from Cold Start.

a. Type: `BOOT DBURST |`

b. Press program load on front panel, then type BURST in response to `FILENAME?`

In either case, DBURST will display:

```
**6099 DISK BACKUP/RESTORE — REV xx.xx**  
COMMAND?
```

- Respond with appropriate command (DUMP, LOAD, OWNER) followed by a carriage return.

Using the Dump Command

- Respond to the *COMMAND?* question by typing **DUMP**.
The program then asks:
INPUT DISK NAME?
- Respond with the disc unit name (i.e., DP0). The program then asks:
DISKETTE UNIT?
- You should respond with the unit name to which you wish to dump the disc (i.e., DP1). The program will then prompt:
*I AM ABOUT TO COPY Dxx TO Dxx
SHALL I CONTINUE? (TYPE "Y" TO PROCEED)*
- If you have entered the proper units, type **Y**, if not strike any other key to restart. If you enter **Y**, the program will begin dumping. When the end of the first diskette is reached, the program will prompt:
LOAD DISKETTE xxx, (STRIKE "R" WHEN READY)
- Here, *xxx* is the diskette number sequence in octal. Replace the current diskette with the next one. When you strike **R**, the dump will continue. Keep loading diskettes as needed until the program issues the message:
DO YOU WISH TO VERIFY YOUR DUMP? (TYPE "Y" TO PROCEED)
- It is strongly recommended that you verify your dump, since media errors are more likely to be detected when verifying, than when dumping. This will be your only opportunity to verify your dump. If you wish to have your dump verified, type **Y**, otherwise strike any other key. If you type **Y**, the program will display:
*****DISKETTE VERIFICATION COMPLETE*****
Otherwise, the program displays:
*****DISK TO DISKETTE DUMP COMPLETE*****

Using the Load Command

This command will cause the program to ask roughly the same questions as the **DUMP** command, but in a different order. Respond appropriately as described above. If during the **LOAD** process, **DBURST** specifies that it was unable to restore certain blocks on disc, record a list of these block numbers and use the **OWNER** command to determine which files were using these blocks. (See your release notice for error messages issued by **DBURST**.)

Module 11

Lab Exercise

If you generated STUDENTSYS in Module 3, you can turn tuning on and exercise your system. Create some files, do some editing, and develop and execute some programs to provide data for the tuning report. Then, turn tuning off and print the tuning report.

You can also generate another system that is tailored to your configuration. You can skip the steps that initialize your disc and load the release files. Just make SYSGEN your current directory, and invoke the SYSGEN program using a name other than STUDENTSYS. This time update your system according to your update documentation.

Module 11

Quiz

List the six major steps involved in the installation and maintenance of an RDOS system.

1. _____
2. _____
3. _____
4. _____
5. _____
6. _____

List the three kinds of multiplexors supported by RDOS.

7. _____
8. _____
9. _____

Match the following four files created by SYSGEN with their correct definitions.

- | | |
|-------------------------|--------------------------|
| 10. _____ systemname.SG | a. The executable system |
| 11. _____ systemname.LM | b. SYSGEN dialog |
| 12. _____ systemname.OL | c. The system's load map |
| 13. _____ systemname.SV | d. The system's overlays |

Match the following utilities with the function they perform.

- | | |
|------------------|---|
| 14. _____ DBURST | a. Backs up a disc onto magnetic tape. |
| 15. _____ OWNER | b. Backs up a disc onto diskettes. |
| 16. _____ BURST | c. Determines the files in which bad blocks were found. |

Match the following I/O operations with their correct definitions.

- | | |
|------------------------|--|
| 17. _____ SPOOLing | a. Transfers data between memory and disc. |
| 18. _____ Direct Block | b. Information transferred between memory and disc is temporarily stored in a system buffer. |
| 19. _____ Buffered | c. Information is stored in a temporary file on disc until a slow device is ready to receive it. |

Match the following CLI commands with the function they perform.

- | | | |
|-----------|------------------------------|-------------------------------------|
| 20. _____ | BSYSGEN
NSYSGEN
SYSGEN | a. Perform system generation |
| 21. _____ | TUPRINT | b. Stop spooling |
| 22. _____ | CLEAR | c. Disable spooling |
| 23. _____ | SPKILL | d. Enable spooling |
| 24. _____ | SPDIS | e. Turn tuning off |
| 25. _____ | SPEBL | f. Turn tuning on |
| 26. _____ | TUON | g. Print the tuning file |
| 27. _____ | TUOFF | h. Reset a file's use count to zero |

Complete the following sentences.

28. The _____ feature allows RDOS to monitor its own efficiency,
29. and it reports the results in the _____.
30. A _____ occurs when a request for a system stack, cell, or buffer cannot be granted because that resource is not available.
31. The program that generates a custom-built system is called _____.
32. Data General supplies _____, which will update the operation of RDOS.
33. The _____ is a skeleton version of RDOS, which will run on any configuration that will support RDOS.
34. A _____ is a request to RDOS for use of its resources.
35. When you boot RDOS it comes up in background and invokes the CLI on the _____ console.
36. A mapped system often has a _____ console that operates in the foreground. It is independent of any multiplexor.
37. The execution path of a set of instructions generated by a system call is called a _____.
38. The procedure used to get a copy of memory after a system failure is called a _____.
39. If you want Data General to analyze your system failure, you may be asked to fill out a report called _____.
40. RDOS uses system _____ and _____
41. to service each system task.
42. RDOS uses system _____ to receive system overlays and as temporary storage locations during I/O.

Match the following conditions that halt processing with their correct definition.

- | | |
|------------------------------|---|
| 43. _____ Crash | a. Processing stops, no message displayed |
| 44. _____ Exceptional Status | b. Processing stops, usually a violation of MAP |
| 45. _____ Trap | c. Processing stops, error message displayed |

Given the following example configuration, answer the questions below. You would normally encounter these questions during installation of a system tailored to this configuration. You may refer back to the documentation in the Student Guide when answering these questions.

The configuration consists of a mapped ECLIPSE C/330 with 256K words of memory. There are two discs and two magnetic tape transports. One of the disc drives is a Model 6060 top-loader on its own controller. You want to install the system on a formatted disc pack, which is already in this drive. The second disc drive is a Model 6045 top-loader with a lower fixed disc; it too is on its own controller. There is currently no disc cartridge in this drive. The two mag tape transports share a primary controller. There are two soft-copy consoles in this system, and there is a single data channel line printer. Generate your system so that, in case of system failure, you will be able to send Data General the required information.

46. What flavor of RDOS do you need?
47. When you load the disc initializer from mag tape, it asks DISK DRIVE MODEL NUMBER? What do you type?
48. It then asks DISK UNIT? What do you type?
49. It then prompts COMMAND? What do you type?
50. Assume that you have now initialized the disc, installed the bootstrap root, the starter system, and the system generation programs. You're in the master directory; name the three CLI commands that will load the utility programs correctly.
51. You've loaded all the release files. Now name the CLI command that will invoke the system generation program. Call your system QUIZ.
52. The system generation program asks: PROCESSOR TYPE? ("1" = C/300 "2" = C/330 "3" = C/350); what do you type?
53. When the system generation program asks NUMBER OF NOVADISK CONTROLLERS (0-2), what do you type?

54. When the system generation program asks NUMBER OF 6060/6061/6067/6122 DISK CONTROLLERS (0-2), what do you type?
55. When the system generation program asks NUMBER OF OTHER TYPES OF MOVING HEAD CONTROLLERS (0-2), what do you type?
56. When the system generation program asks ENTER NUMBER OF EXTRA BUFFERS REQUIRED (0-63), what is the recommended response?
57. When the system generation program asks ENTER NUMBER OF CONTROLLERS FOR MTA (0-2), what do you type?
58. The system then asks DEVICE PRIMARY ("0") OR SECONDARY ("1")?. What do you type?
59. The program next asks ENTER NUMBER OF DEVICES FOR CONTROLLER #1 (1-8)?. What do you type?
60. Later the program asks QTY? ("0" = NO "1" = YES). What do you type?
61. Later the program asks SECOND TTY? ("0" = NO "1" = YES). What do you type?
62. The program then asks CORE DUMP FACILITY? ("0" = NO "1" = LPT "2" = MTA "3" = 6030 "4" = 6097). What do you type?

Check your answers with those given in *Appendix A: Quiz Answers*. Score one point for each correct answer. The maximum score is 62 points. Mastery level is 50 points. If you achieve the mastery level, you have completed this course. Otherwise, review the material presented in this module.

Appendix A

Quiz Answers

Module 2

1. the CPU
Memory System
I/O System
2. bit
3. page
4. Read/Write
5. CLI
6. tracks
7. reset
8. R
9. Core
10. Semiconductor
11. byte
12. Product Release Notice
13. binary
14. file
15. Foreground-Background
16. octal
17. Read-Only Memory or ROM
18. PC or program counter
19. IR or instruction register
20. arithmetic/logic
21. primary controller
secondary controller
22. flavors
23. direct program

24. MAP
25. address
26. Fixed-head
27. Moving-head
28. Utility
29. data channel
30. device code
31. multiplexor
32. word
33. system generation
34. control
35. accumulators
36. controller
37. ASCII
38. baud rate
39. tuning
40. Magnetic tape drives
41. Disc drives
42. front panel
programmed
43. On/Off
44. lock
45. data switches
46. program load

Module 4

1.
 - a. Power up equipment.
 - b. Load the disc that contains the RDOS system.
 - c. Boot the system.
2. bootstrapping
3. system (or programmed)
4. bootstrap loader
5. ALPHA LOCK KEY
6. RELEASE %MDIR%

7. A. Hardware Data Switches

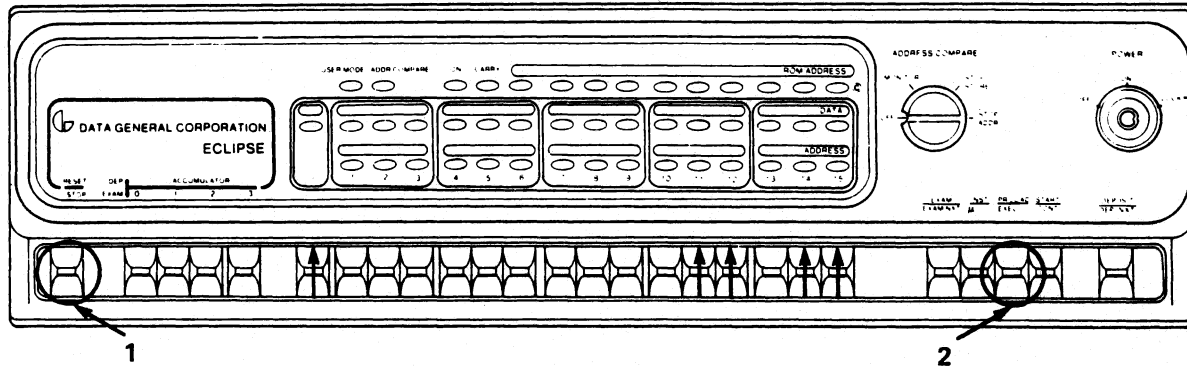

CS-01155

Figure 4.7 Front Panel — ECLIPSE

What should you enter in response to the prompt:

FILENAME? QUIZSYS!

B. Programmed Console

Indicate what must be entered to perform an automatic program load:

!100033L

What should you enter in response to the prompt:

FILENAME? QUIZSYS!

Module 5

1. CLI response: 07-04-80

Explanation: SDAY sets the system date to July 4, 1980, and the MESSAGE command is used with a CLI variable to display that date.

2. CLI response: R

Explanation: The words "THIS IS A TEST" are sent to the line printer.

3. CLI response: FILE ALREADY EXISTS: TEST1

Explanation: The /B switch is needed to append information to an existing file.

4. CLI response: I'M FILE TWO

Explanation: The commercial at signs cause CLI to access the contents of file ONE, which is the filename TWO.

5. CLI response: DELETED F1
DELETED F2

Explanation: A macro is created and then executed. The macro creates F1 and F2, then deletes them both.

6. b
7. i
8. j
9. k
10. h
11. g
12. m
13. s
14. d
15. o
16. z
17. c
18. t
19. a
20. y
21. x
22. r
23. e
24. u
25. l
26. p
27. f
28. v
29. n
30. w
31. q

- 32. argument
- 33. macro
- 34. indirect
- 35. global
- 36. local
- 37. LOG.CM
- 38. CLI variables

Module 6

- 1. j
- 2. f
- 3. q
- 4. g
- 5. r
- 6. w
- 7. u
- 8. n
- 9. t
- 10. o
- 11. a
- 12. m
- 13. s
- 14. i
- 15. h
- 16. b
- 17. l
- 18. e
- 19. k
- 20. d
- 21. v
- 22. p
- 23. c
- 24. a
- 25. a

26. b
27. c
28. a
29. b
30. a
31. b
32. c
33. b,c
34. c
35. a,b,c
36. a,b
37. initialization
38. logical block address
39. master directory
40. resolution file
41. characteristics
42. attributes
43. link entry
44. SYS.DR
45. User File Description (UFD)
46. MAP.DR
47. Hash value offset
48. current directory
49. dump
50. copy
51. Disc editor
52. frame size
53. templates
54. block
55. directory specifier
56. logical end of tape

Module 7

1. l
2. h
3. b
4. q
5. u
6. n
7. z
8. c
9. f
10. d
11. m
12. p
13. o
14. a
15. i
16. j
17. r
18. v
19. t
20. s
21. k
22. g
23. e
24. w
25. x
26. y
27. d
28. a
29. c
30. b
31. e
32. Invoke SPEED
33. If an input file exists, open it

34. Open an output file
35. Yank a portion of text into the buffer
36. Insert/modify text
37. Put text to output file
38. Close files
39. Exit from SPEED
40. Character pointer (CP)
41. Edit buffer
42. Escape or Alt mode
43. Yank
44. Put

Module 8

1. Compiler
2. Assembler
3. relocatable object code
4. listfile
5. translator
6. Text
7. interpreter
8. relocatable loader, or RLDR
9. relocatable object format
10. save file
11. loadmap
12. save format
13. library file
14. SYS.LB
15. Relocatable object file, output from translator
16. Executable, save file, output from RLDR
17. library file, collection of relocatable object files
18. a. FORT TEST
b. MAC TEST \$LPT/L or MAC TEST \$TTO/L
19. FORTRAN: RLDR TEST FORT.LB
Assembly: RLDR TEST

20. TEST
21. a. BASIC
b. LIST TEST
c. ENTER TEST
d. RUN

Module 9

1. a,c,d
2. b,d
3. a,b,c
4. a,b,c,d
5. a,c,d
6. True
7. False
8. True
9. True
10. False
11. True
12. True
13. physical address page 67, offset 2
14. physical
15. logical
16. logical
- 17., 18. remapping, logically
19. MMU or Memory Management and Protection Unit
20. MAP or Memory Allocation and Protection Unit
21. memory node
22. extended memory
23. I/O instructions prohibited
24. Address Validity Protection

Module 10

1. True
2. True
3. False

4. True
5. False
6. True
7. False
8. False
9. True
10. True
11. GMEN
12. SMEM
13. EXFG
14. FRGD
15. CTRL-F
16. \$TTI1
17. \$TTO1
18. FLOG.CM

Module 11

1. Determine the correct RDOS flavor.
2. Install the starter system.
3. Perform system generation.
4. Update (patch) the system.
5. Use the system.
6. Tune the system.
- 7., 8., 9. Asynchronous Line Multiplexor (ALM), Asynchronous Communications Multiplexor (QTY), Universal Line Multiplexor (ULM)
10. b
11. c
12. d
13. a
14. b
15. c
16. a

- 17. c
- 18. b
- 19. a
- 20. a
- 21. g
- 22. h
- 23. b
- 24. c
- 25. d
- 26. f
- 27. e
- 28., 29. tuning, tuning report (file)
- 30. fault
- 31. SYSGEN
- 32. patch
- 33. starter system
- 34. system call
- 35. primary
- 36. secondary
- 37. system task
- 38. core dump
- 39. software trouble report (STR)
- 40., 41. stacks, cells
- 42. buffers
- 43. a
- 44. c
- 45. b
- 46. ZRDOS)
- 47. 6060)
- 48. DZ0)
- 49. FULL)

50. CDIR UTIL }
DIR UTIL }
LOAD/V MT0:6 }

51. BSYSGEN QUIZ.<SV/S SG/V LM/L> }

52. 2 }

53. 0 } or }

54. 1 }

55. 1 }

56. 8 }

57. 1 }

58. 0 } or }

59. 2 }

60. 0 } or }

61. 1 }

62. 2 }

Appendix B

I/O Device Codes

Device Code (Octal)	Device
00	Power fail
01*	Writeable control store
02*	Error checking and correction
03*	Memory Allocation and Protection
01 +	Multiply/Divide
02 +	Memory Management and Protection Unit
02** +	
03 +	Memory Allocation and Protection
04 +	
05	
06	Multiprocessor adapter transmitter
07	Multiprocessor adapter receiver
10	Teletype input
11	Teletype output
12	Paper tape reader
13	Paper tape punch
14	Real time clock option
15	Incremental plotter
16	Card reader
17	Line printer
20	Fixed head disc
21	A/D converter
22	Magnetic tape
23	D/A converter
24	Data communications multiplexor
25	
26	
27	Moving-head disc drive (multi-platter pack)
30	Asynchronous hardware multiplexor
31**	IBM 360/370 interface
32	IBM 360/370 interface
33	Moving-head disc
34	Cassette tape
34**	Multiline asynchronous controller
35	Multiline asynchronous controller
36	Interprocessor bus — half-duplex
37	IPB watchdog timer
40	IPB full-duplex input
41	IPB full-duplex output

Device Code (Octal)	Device
40 + +	Synchronous communication receiver
41 #	Synchronous communication transmitter
42	Digital I/O
43	Digital I/O timer
44	Modem control for multiline asynchronous controller
45	
46	Second multiprocessor transmitter
47	Second multiprocessor receiver
50	Second teletype input
51	Second teletype output
52	Second paper tape reader
53	Second paper tape punch
54	Second real time clock option
55	Second incremental plotter
56	Second card reader
57	Second line printer
60	Second fixed-head disc
61	A/D converter
62	Second magnetic tape
63	D/A converter
64** +	
65 +	Alternate location for floating point
66 +	
67	
70	Second asynchronous hardware multiplexor
70	Second synchronous line adapter
71**	Second IBM 360/370 interface
72	Second IBM 360/370 interface
73	Second moving-head disc
74	Second cassette tape
74**	Second multiline asynchronous controller
75	
75* +	
75 +	Floating point
76 +	
77	Central processor and console functions

- * ECLIPSE computer only
- + NOVA line computers only
- ** Code returned by INTA and used by VCT for ECLIPSE computer
- + + May be set up with any unused even device code 40 or greater
- # May be set up with any unused odd device code 41 or greater

Appendix C

ASCII Character Set

DECIMAL	OCTAL	HEX	SYMBOL	REMARKS
0	000	00	↑⓪	NUL
1	001	01	↑A	SOH
2	002	02	↑B	STX
3	003	03	↑C	ETX
4	004	04	↑D	EOT
5	005	05	↑E	ENQ
6	006	06	↑F	ACK
7	007	07	↑G	BEL
8	010	08	↑H	BS (Backspace)
9	011	09	↑I	TAB
10	012	0A	↑J	NEW LINE
11	013	0B	↑K	VT (Vertical Tab)
12	014	0C	↑L	FORM FEED
13	015	0D	↑M	CARRIAGE RETURN
14	016	0E	↑N	SO
15	017	0F	↑O	SI
16	020	10	↑P	DLE
17	021	11	↑Q	DC1
18	022	12	↑R	DC2
19	023	13	↑S	DC3
20	024	14	↑T	DC4
21	025	15	↑U	NAK
22	026	16	↑V	SYN
23	027	17	↑W	ETB
24	030	18	↑X	CAN
25	031	19	↑Y	EM
26	032	1A	↑Z	SUB
27	033	1B	ESC	ESCAPE
28	034	1C	↑\	FS
29	035	1D	↑	GS
30	036	1E	↑↑	RS
31	037	1F	↑←	US
32	040	20	SPACE	
33	041	21	!	
34	042	22	"	
35	043	23	#	
36	044	24	\$	
37	045	25	%	
38	046	26	&	
39	047	27	'	
40	050	28	(
41	051	29)	
42	052	2A	*	
43	053	2B	+	
44	054	2C	,	
45	055	2D	-	
46	056	2E	.	
47	057	2F	/	
48	060	30	0	
49	061	31	1	
50	062	32	2	
51	063	33	3	
52	064	34	4	
53	065	35	5	
54	066	36	6	
55	067	37	7	
56	070	38	8	
57	071	39	9	
58	072	3A	:	
59	073	3B	;	
60	074	3C	<	
61	075	3D	=	
62	076	3E	>	
63	077	3F	?	
64	100	40	@	
65	101	41	A	
66	102	42	B	
67	103	43	C	
68	104	44	D	
69	105	45	E	
70	106	46	F	
71	107	47	G	
72	110	48	H	
73	111	49	I	
74	112	4A	J	
75	113	4B	K	
76	114	4C	L	
77	115	4D	M	
78	116	4E	N	
79	117	4F	O	
80	120	50	P	
81	121	51	Q	
82	122	52	R	
83	123	53	S	
84	124	54	T	
85	125	55	U	
86	126	56	V	
87	127	57	W	
88	130	58	X	
89	131	59	Y	
90	132	5A	Z	
91	133	5B	[
92	134	5C	\	
93	135	5D]	
94	136	5E	↑^	
95	137	5F	↑_	
96	140	60	↑`	
97	141	61	a	
98	142	62	b	
99	143	63	c	
100	144	64	d	
101	145	65	e	
102	146	66	f	
103	147	67	g	
104	150	68	h	
105	151	69	i	
106	152	6A	j	
107	153	6B	k	
108	154	6C	l	
109	155	6D	m	
110	156	6E	n	
111	157	6F	o	
112	160	70	p	
113	161	71	q	
114	162	72	r	
115	163	73	s	
116	164	74	t	
117	165	75	u	
118	166	76	v	
119	167	77	w	
120	170	78	x	
121	171	79	y	
122	172	7A	z	
123	173	7B	{	
124	174	7C		
125	175	7D	}	
126	176	7E	↑~	
127	177	7F	DEL	

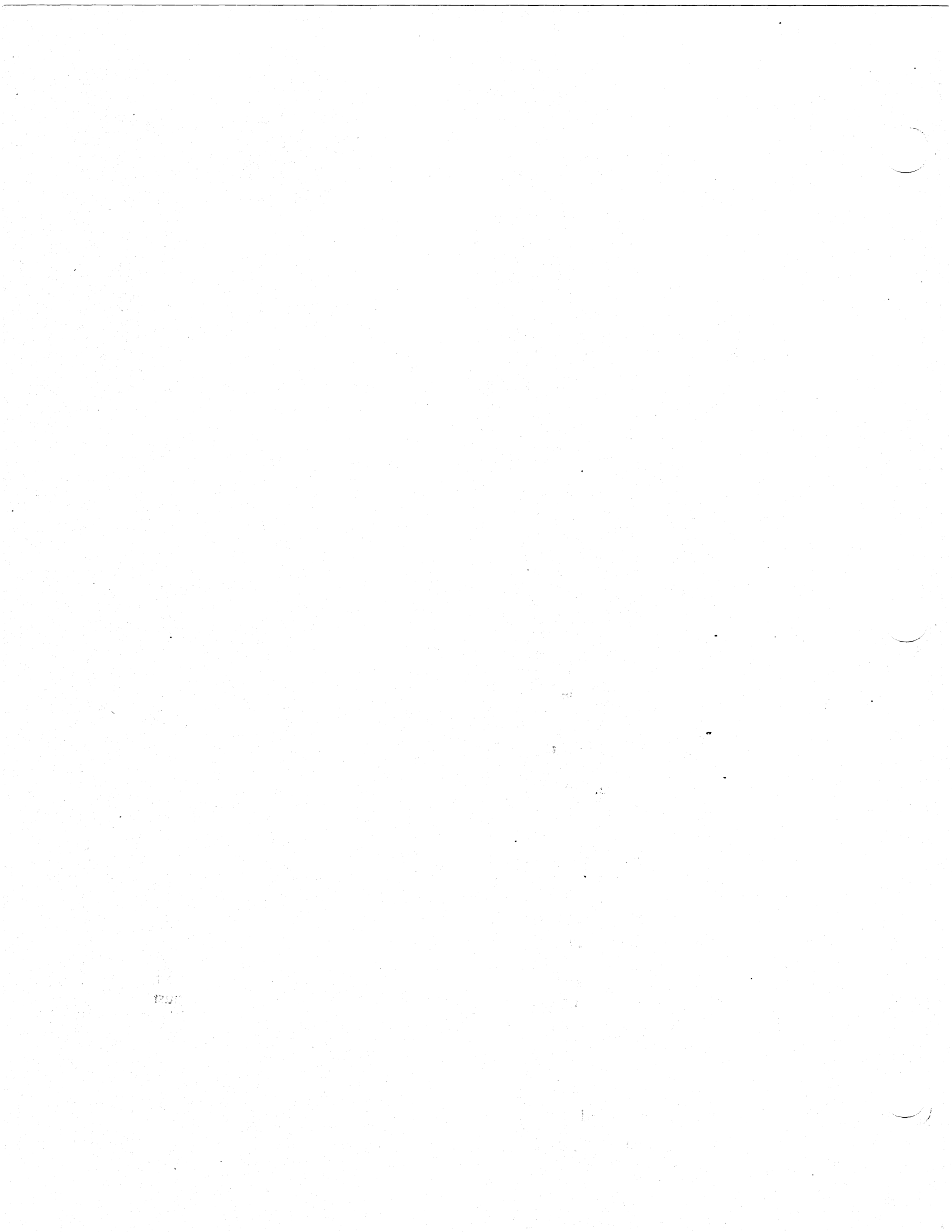

Appendix D

Modems

Modem Support under RDOS

Data General provides a modem control interface on some of its asynchronous multiplexors. This allows for software written to handle these multiplexors to control a number of different asynchronous modems. These modems must support a subset of the EIA RS-232C interface standard.

The modem must supply the following signals:

- Receive Data
- Clear to Send (may be strapped to DSR or RTS)
- Ring Indicator
- Either Carrier Detect or Data Set Ready (see below)

Any signal not active, but wired in the interface cable, should be properly terminated to avoid false activation.

The modem must be fully operative by controlling only the following signals:

- Transmit Data
- Request to Send
- Data Terminal Ready

In situations where the modem is used to allow remote consoles to be connected to a DG system via the bell switched voice network, the following requirements must be met:

- Full-Duplex Capability
- Auto-Answer Capability
- Equal Transmit and Receive Data Rates
- Data Terminal Ready Low Forcing Disconnect

If you use the "Standard Modem Timer" software option (Rev 6.6+), the modem must supply carrier detect. This is necessary for the proper handling of connect/disconnect procedures by RDOS.

If you do not use the "Standard Modem Timer" software package (Rev 6.6+), these signals must also be provided:

- Data set ready high after carrier detect.
 - Data set ready low after disconnect.
- The modem must be able to recognize a disconnect and drop data set ready. Loss of carrier detect is not sufficient to determine when to drop data set ready. Bell modems use direct current on the phone line as an indication of a disconnect, and thus drop data set ready. If the modem does not provide this function, the line will appear busy to the next caller if the previous caller has hung up.

Options Not Supported

- "Long" or "Short" space disconnect
- Auto-call unit

Unimportant Options

- Voice Mode
- Keypad Controls
- Originate Mode (depending on your overall requirements)

The form of the hang-up notification sent to line 64 is as follows:

0	1	2	3	4	5	6	7	8	9	10	11	12	13	14	15	
0	1	LINE NUMBER						0	0	0	0	0	0	0	0	0

CS-01157

and will be returned in AC2.

During system generation, if either ALM or ULM is selected, you will be asked:

ARE THERE ANY MODEMS? ("0" = NO "1" = YES)

You need answer "1" (yes) only if you want to use modems, regardless of whether or not they actually exist. If you answer "no," then modem interrupts will be ignored; although it is still possible to control the modem with writes to QTY:64.

If your answer is affirmative, then you will be asked:

STANDARD MODEM TIMER? ("0" = NO "1" = YES)

It is highly recommended that you answer "1" (yes); the standard timer package will provide support of all known modems. It answers a ring, waits up to 90 sec for indication of data (carrier), permits data dropouts of up to 5 sec, and disconnects either at timeout or user request (QTY:64 WRITE). It includes state logic to filter modem signal anomalies. The timer is a system task, which runs in an overlay once every 5 sec, but only when a modem is connected and there is no carrier. It does not run when all modems are either inactive or passing carrier. Additionally, the user may select, on a line-by-line basis (in ALMSPD), that data set ready, rather than carrier, be monitored for those cases where he has either a half-duplex line, or no carrier, or wants to defeat timeout. There is one word required per line to support the timer.

The other modem option, selected by answering "0" (no) to the timer question, is similar to previous RDOS modem support. It answers on ring, uses data set ready as a connect state, and will disconnect on either loss of data set ready, or user signal (QTY:64 WRITE). It cannot automatically handle nuisance calls, or modems that do not drop data set ready on line loss. It has been adequate in the U.S. with telephone company modems, however. This driver is a few words smaller than the standard timer, and involves less system overhead.

If you answered "1" (yes) to any of the QTY or ALM or ULM questions, you will be asked:

NUMBER OF LINES? (1-64)

The driver has been written to ignore I/O activity on lines beyond the number you SYSGEN. In the case of the DG/CS (ALM, ULM), it will turn off lines not generated, as they interrupt. No attempt is made to initialize lines not generated. The cost in RDOS is one word per line for QTY (4060-TYPE MUX), two words per line for DG/CS (ALM, ULM) without modem timing software, and three words per line for DG/CS with modem timing software (Standard Modem Timers).

