

THIS DRAWING AND SPECIFICATIONS, MEMO, AND THE PROPERTY OF DATA GENERAL CORPORATION AND SHALL NOT BE REPRODUCED OR COPIED OR USED IN WHOLE OR IN PART AS THE BASIS FOR MANUFACTURE OR SALE OF ITEMS WITHOUT WRITTEN PERMISSION.

REVISIONS				
REV	DESCRIPTION	DRFTG	APP BY	DATE
01	ECO# 1002	R.W.C.		6/72
02	ECO# 1117	R.W.C.		10/72
03	ECO# 1259	R.W.C.		2/73

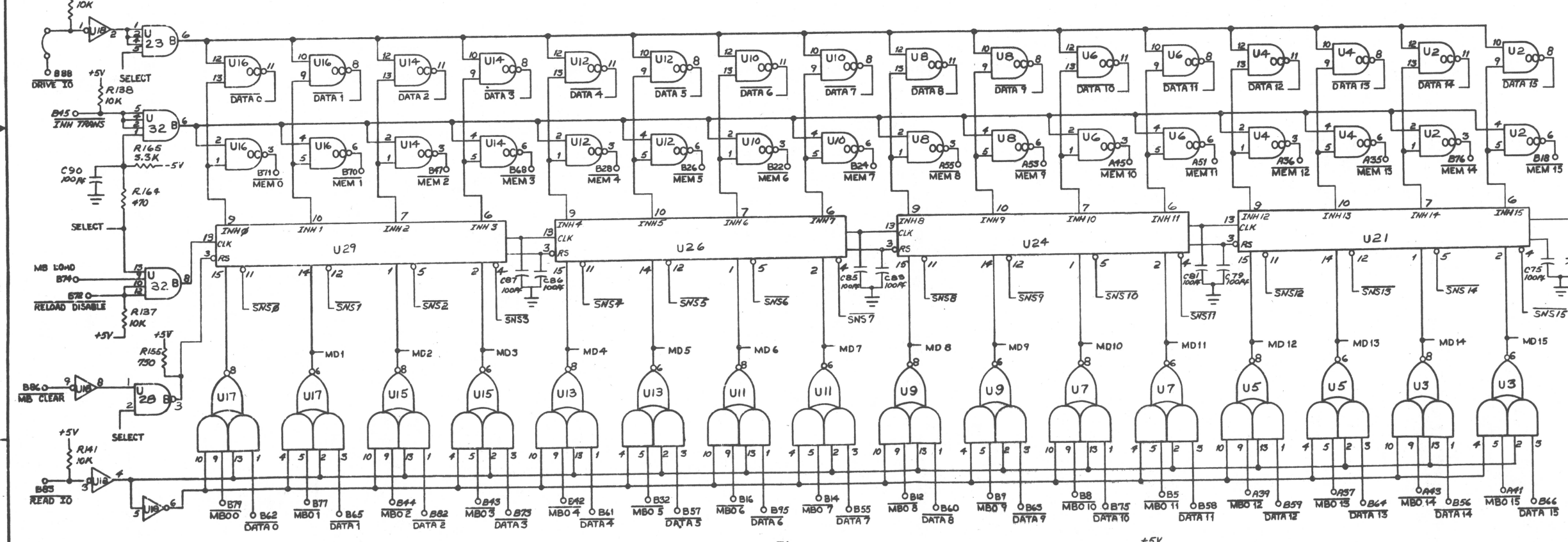

NOTE: ALL CAPACITORS ARE IN MICROFARADS, AND ALL RESISTORS ARE IN OHMS, 1/4 WATT, WITH 5% TOLERANCE UNLESS OTHERWISE SPECIFIED.

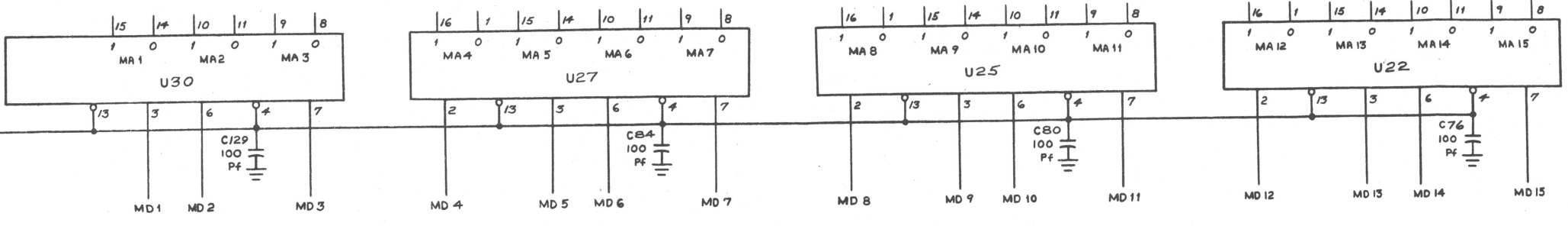
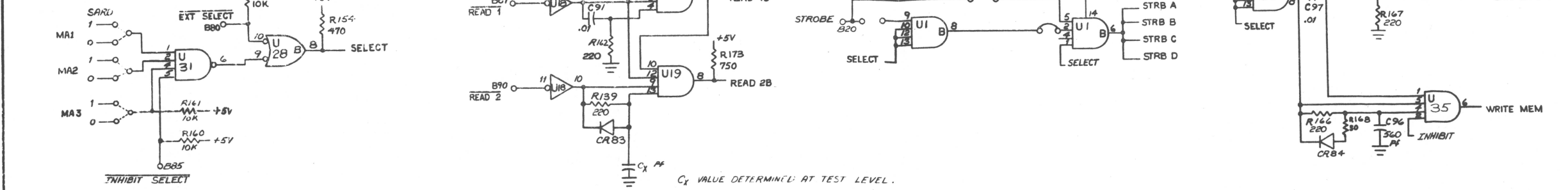
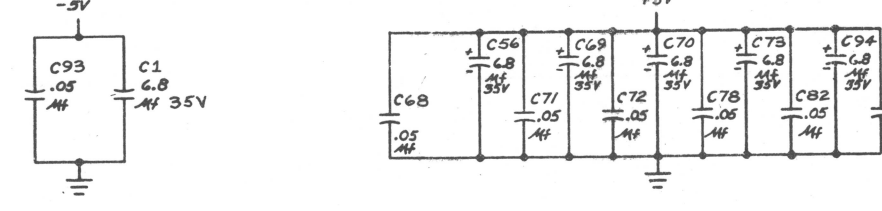

QTY.	DESCRIPTION	PART NO.
	UNLESS OTHERWISE SPECIFIED - DIMENSIONS ARE IN INCHES TOLERANCES ON FRACTIONS DECIMALS ANGLES	
	JOX =	
	PARTS TO BE FREE FROM BURRS BREAK ALL EDGES .010	
	UNLESS OTHERWISE SPECIFIED - ALL MACH SURFACES	
	FINISH	
	DRAWN CHET JOHNSON 9/2/71	
	CHECKED	
	ENGINEER	
	APPROVED	
	FIRST USED ON 107-000137	
	SCALE	
DATA GENERAL CORPORATION SOUTHBORO, MASSACHUSETTS 01772		
TITLE 8K MEMORY MA & MB REGISTER & CONTROL		
SIZE D 001	DRAWING NUMBER 000238	REV 03



THIS DRAWING AND SPECIFICATIONS, HEREIN, ARE THE PROPERTY OF DATA GENERAL CORPORATION AND SHALL NOT BE REPRODUCED OR COPIED OR USED IN WHOLE OR IN PART AS THE BASIS FOR MANUFACTURE OR SALE OF ITEMS WITHOUT WRITTEN PERMISSION.

REVISIONS				
REV.	DESCRIPTION	DRFTG.	APP. BY	DATE

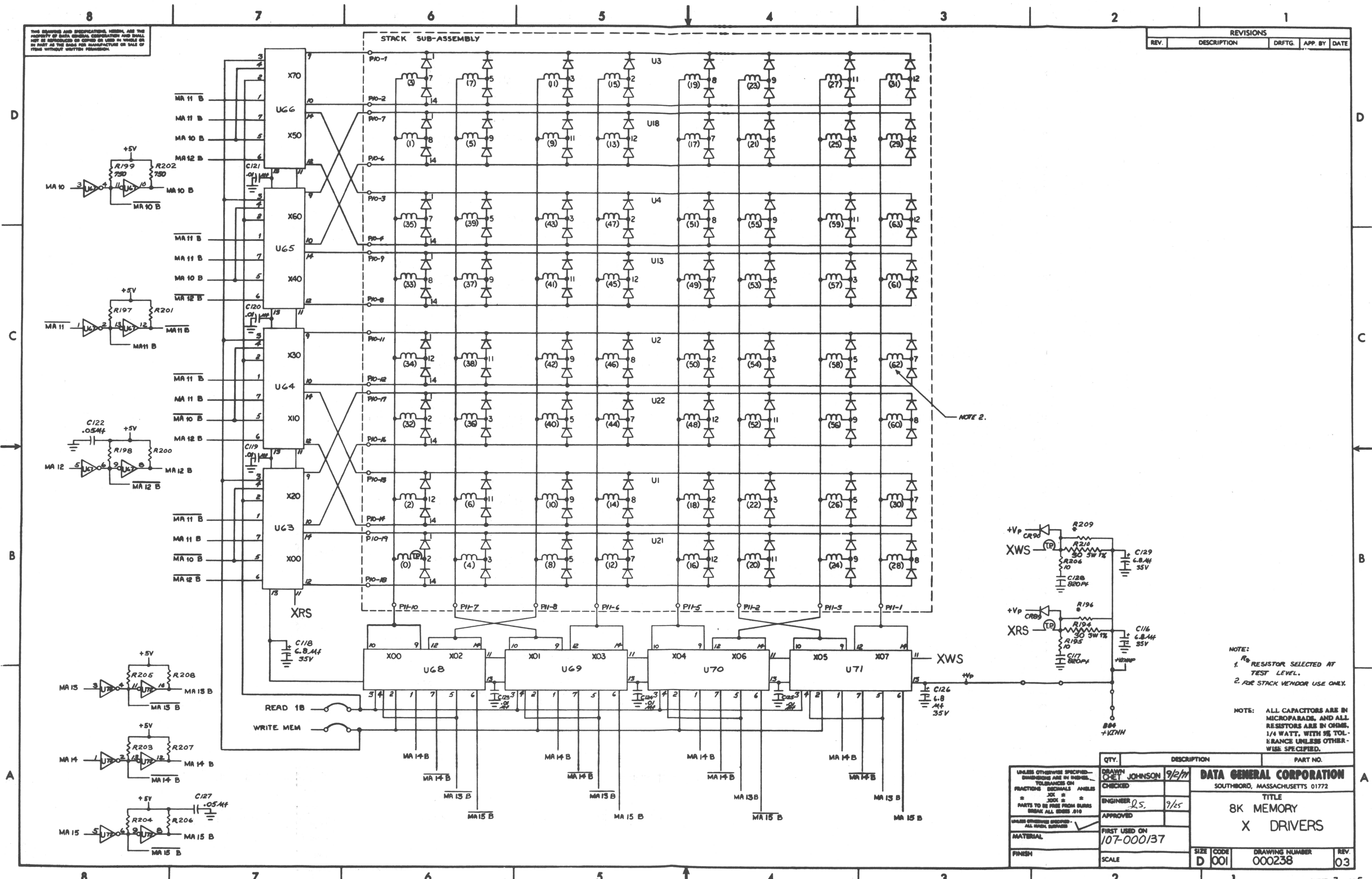

NOTE 2.

- NOTE:
- R<sub>20</sub> RESISTOR SELECTED AT TEST LEVEL.
  - FOR STACK VENDOR USE ONLY.

NOTE: ALL CAPACITORS ARE IN MICROFARADS, AND ALL RESISTORS ARE IN OHMS, 1/4 WATT, WITH 5% TOLERANCE UNLESS OTHERWISE SPECIFIED.

QTY.	DESCRIPTION	PART NO.

  

UNLESS OTHERWISE SPECIFIED—DIMENSIONS ARE IN INCHES. TOLERANCES ON FRACTIONS DECIMALS ANGLES	DRAWN CHET JOHNSON 9/2/71	<b>DATA GENERAL CORPORATION</b> SOUTH BORD, MASSACHUSETTS 01772 TITLE <b>8K MEMORY          X DRIVERS</b>
* JOG * PARTS TO BE FREE FROM BURRS BREAK ALL EDGES .010	CHECKED 	
UNLESS OTHERWISE SPECIFIED—ALL READ SERVICES	ENGINEER R.S. 9/25	
	APPROVED 	
MATERIAL	FIRST USED ON 107-000137	DRAWING NUMBER 000238
FINISH	SCALE	REV. 03



THIS DRAWING AND SPECIFICATIONS, HEREIN, ARE THE PROPERTY OF DATA GENERAL CORPORATION AND SHALL NOT BE REPRODUCED OR COPIED OR USED IN WHOLE OR IN PART AS THE BASIS FOR MANUFACTURE OR SALE OF ITEMS WITHOUT WRITTEN PERMISSION.

REVISIONS				
REV.	DESCRIPTION	DRFTG.	APP. BY	DATE

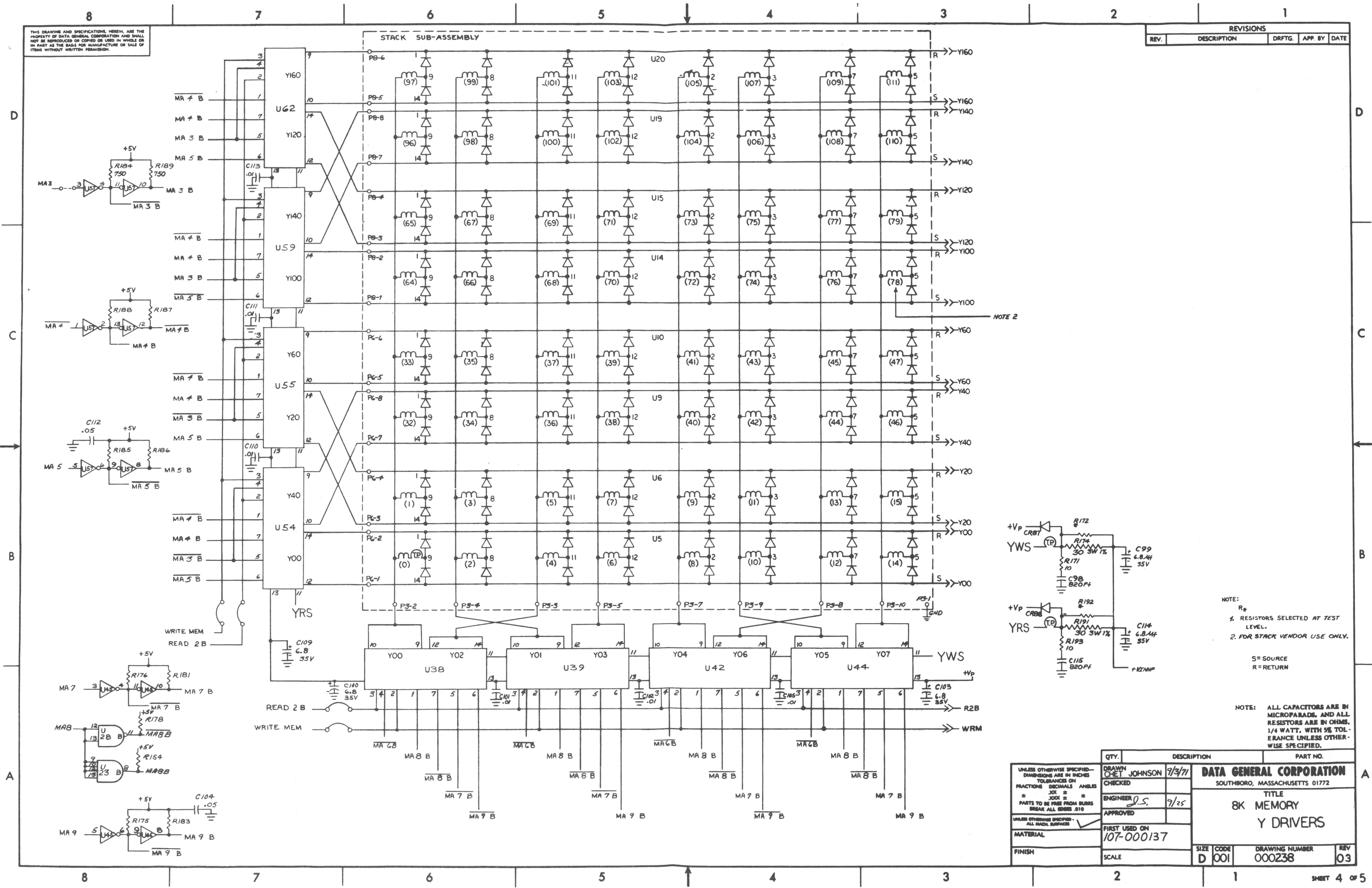

NOTE 2

NOTE:  
 R<sub>s</sub>  
 1. RESISTORS SELECTED AT TEST LEVEL.  
 2. FOR STACK VENDOR USE ONLY.  
 S=SOURCE  
 R=RETURN

NOTE: ALL CAPACITORS ARE IN MICROFARADS, AND ALL RESISTORS ARE IN OHMS. 1/4 WATT, WITH 5% TOLERANCE UNLESS OTHERWISE SPECIFIED.

QTY.	DESCRIPTION	PART NO.

UNLESS OTHERWISE SPECIFIED - DIMENSIONS ARE IN INCHES FRACTIONS DECIMALS ANGLES X.XX = .XX X.XXX = .XXX PARTS TO BE FREE FROM BURRS BREAK ALL EDGES .010	DRAWN CHET JOHNSON 9/3/71 CHECKED ENGINEER J.S. 9/25 APPROVED FIRST USED ON 107-000137 MATERIAL FINISH	<b>DATA GENERAL CORPORATION</b> SOUTHBORO, MASSACHUSETTS 01772 TITLE <b>8K MEMORY          Y DRIVERS</b> SIZE CODE D 001 DRAWING NUMBER 000238 REV 03
---	---	--



THIS DRAWING AND SPECIFICATIONS HEREIN ARE THE PROPERTY OF DATA GENERAL CORPORATION AND SHALL NOT BE REPRODUCED OR COPIED OR USED IN WHOLE OR IN PART AS THE BASIS FOR MANUFACTURE OR SALE OF ITEMS WITHOUT WRITTEN PERMISSION.

REVISIONS				
REV.	DESCRIPTION	DRFTG.	APP BY	DATE

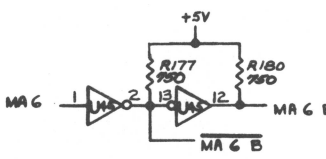
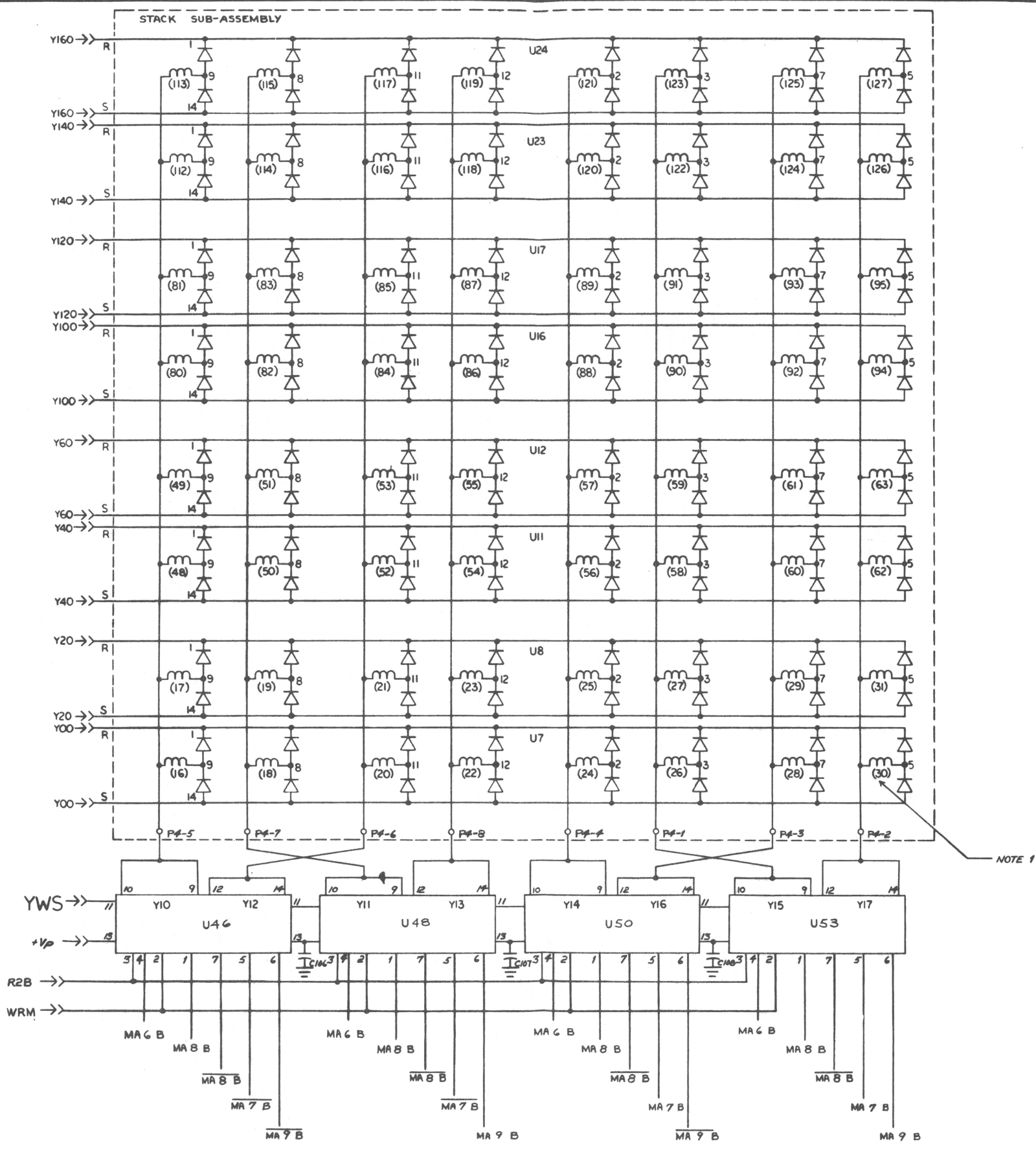

NOTE 1

NOTE:-  
1. FOR STACK VENDOR USE ONLY.

NOTE: ALL CAPACITORS ARE IN MICROFARADS, AND ALL RESISTORS ARE IN OHMS. 1/4 WATT, WITH 5% TOLERANCE UNLESS OTHERWISE SPECIFIED.

QTY.	DESCRIPTION	PART NO.

UNLESS OTHERWISE SPECIFIED— DIMENSIONS ARE IN INCHES TOLERANCES ON FRACTIONS DECIMALS ANGLES X .001 X .005 X .010 X .020 X .030 X .040 X .050 X .060 X .070 X .080 X .090 X .100 X .120 X .150 X .200 X .250 X .300 X .375 X .500 X .625 X .750 X .875 X 1.000 X 1.250 X 1.500 X 1.750 X 2.000 X 2.500 X 3.000 X 3.750 X 4.000 X 5.000 X 6.000 X 7.000 X 8.000 X 9.000 X 10.000	DRAWN CHET JOHNSON 9/3/77 CHECKED ENGINEER D.S. 7/25 APPROVED FIRST USED ON 107-000137 MATERIAL FINISH	<b>DATA GENERAL CORPORATION</b> SOUTHBORO, MASSACHUSETTS 01772 TITLE <b>8K MEMORY Y DRIVERS</b> DRAWING NUMBER 000238 REV 03
---	---	---