

THIS DRAWING AND SPECIFICATIONS HEREIN ARE THE PROPERTY OF DATA GENERAL CORPORATION AND SHALL NOT BE REPRODUCED OR COPIED OR USED IN WHOLE OR IN PART AS THE BASIS FOR MANUFACTURE OR SALE OF ITEMS WITHOUT WRITTEN PERMISSION.

REVISIONS				
REV.	DESCRIPTION	DRFTG	APP BY	DATE
04	ECO #2423	RFJ		6/3/74

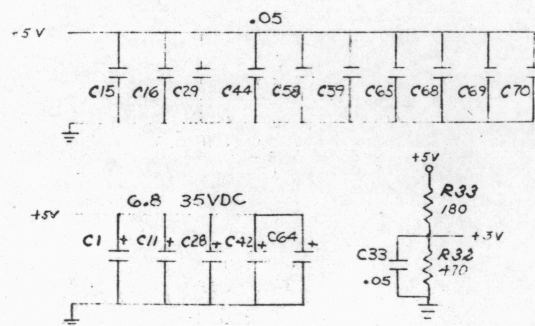
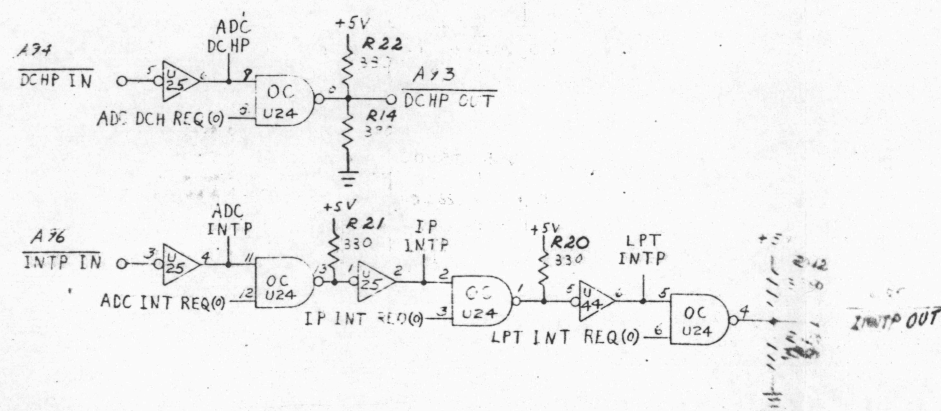
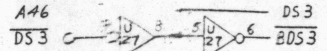
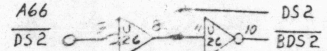
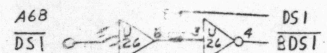
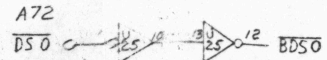
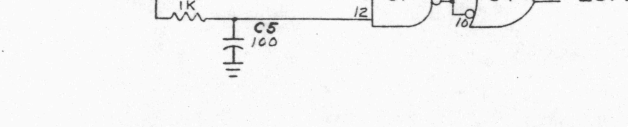
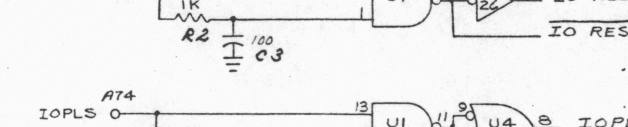
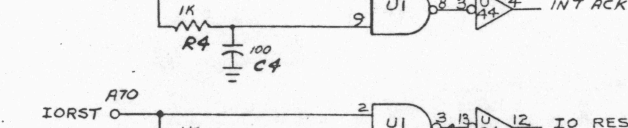
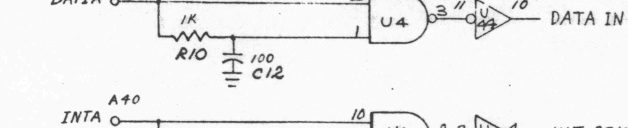
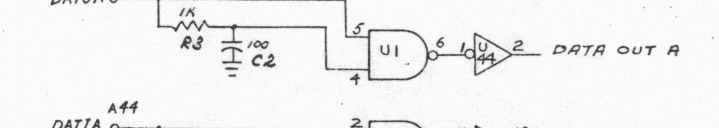
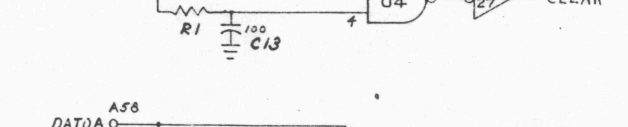
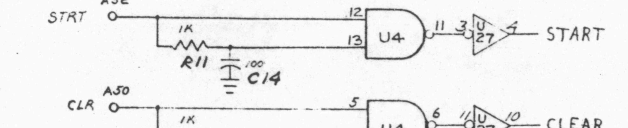
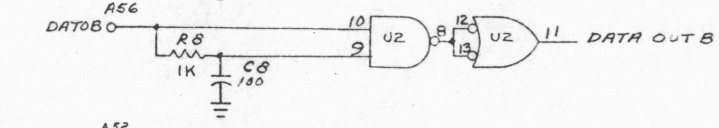
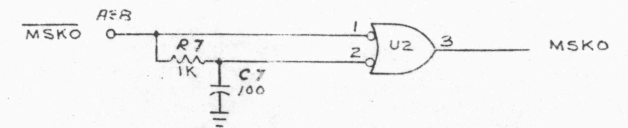
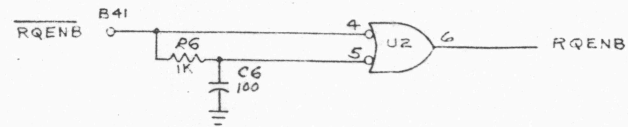
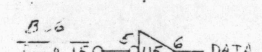
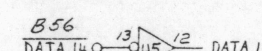
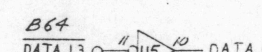
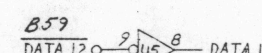
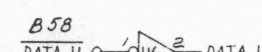
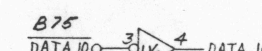
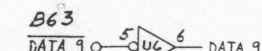
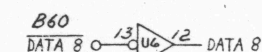
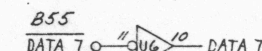
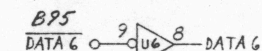
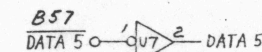
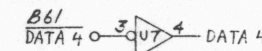
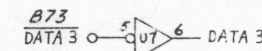
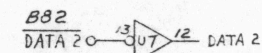
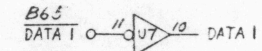
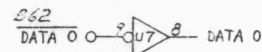

QTY	DESCRIPTION	PART NO.
	DATA GENERAL CORPORATION	
	TITLE COMMON IO	
	FIRST USED ON 4014	DRAWING NUMBER 000041
	SIZE D	CODE 001
	SHEET / OF /	REV. 04